

IET

Soldier's Handbook

TRADOC Pamphlet 600-4
1 October 2003

HEADQUARTERS
DEPARTMENT OF THE ARMY
United States Army Training and Doctrine Command
Fort Monroe, Virginia 23651-5000

FOREWORD

This handbook is a handy pocket reference for subjects in which you must maintain proficiency. It condenses information from field manuals, training circulars, Army regulations, and other sources.

You will need this handbook in initial-entry training (IET). Carry it with you at all times. Use it to review the training you will receive and to prepare for proficiency testing. It will also be useful throughout your military career.

This handbook addresses both general subjects and selected combat tasks. It includes evaluation guides to test your knowledge. You must know this information in order to be an effective soldier. The information on selected combat tasks is important, regardless of your grade or military occupational specialty (MOS).

Unless this handbook states otherwise, masculine nouns and pronouns do not refer exclusively to men.

DEPARTMENT OF THE ARMY
HEADQUARTERS
UNITED STATES ARMY TRAINING AND
DOCTRINE COMMAND
Fort Monroe, Virginia 23651-5000

PERSONNEL—GENERAL

IET SOLDIER'S HANDBOOK

(2 October 2003)

Chapter 1. General Subjects	1-1
Army History	1-1
Heritage and Traditions	1-3
Army Organization.....	1-5
Chain of Command	1-7
Rank Insignia	1-8
Officer	1-8
Warrant Officer	1-10
Enlisted	1-11
Rank Abbreviations	1-12
Military Time	1-12
Customs and Courtesies	1-14
Saluting	1-14
Rendering Honor to the Flag	1-16
Courtesies	1-18
Role of the Chaplain	1-19
Chapter 2. Army Values	2-1
Loyalty	2-2
Duty	2-5
Respect	2-8
Selfless Service	2-12
Honor	2-14
Integrity.....	2-17

Personal Courage	2-22
Chapter 3. Standards of Conduct	3-1
Uniform Code of Military Justice	3-1
Punitive articles	3-4
Forms of Punishment	3-9
Courts-Martial	3-12
Nonjudicial Punishment	3-14
Equal Opportunity Policy	3-15
Complaint Process	3-16
Whistleblower Protection Act	3-18
Fraternization	3-20
Improper Associations	3-21
Sexual Harassment Policy	3-23
Appropriate Behavior	3-27
Alcohol and Drug Abuse	3-27
Consideration of Others	3-28
Homosexual Conduct Policy	3-28
Dignity and Respect	3-32
Rape Prevention	3-32
Suicide Prevention	3-34
Ethical Decision Making	3-38
Awards and decorations	3-38
Terrorism	3-43
Chapter 4. Basic Soldier Skills	4-1
Serve as a member of a Team	4-1
Buddy System	4-2
Drill and Ceremony	4-3
Stationary Positions	4-7
Facing Movements	4-9
Steps and Marching	4-12
Manual of Arms.....	4-15
Inspections	4-35
Personal Appearance and Uniform	4-36
Hairstyle	4-37
Jewelry	4-37

Body Piercing and Tattoos	4-38
Uniform Wear and Maintenance	4-38
Boots	4-39
Insignia Placement	4-39
Individual Equipment	4-45
Bivouac Equipment	4-48
Physical Readiness Training (PRT)	4-52
Phases of PRT	4-53
Components of PRT	4-55
Principles of PRT	4-56
Training Injuries	4-56
Selecting Proper Running Footwear	4-58
Sports Bra Selection	4-60
Nutrition	4-60
Safety	4-63
Prevention of Cold Weather Injuries	4-63
Prevention of Hot Weather Injuries	4-67
Prevention of Hyponatremia	4-70
Field and Personal Hygiene	4-71
Disease Prevention	4-71
Guard Duty	4-74
Interior Guard	4-74
Exterior Guard	4-77
CHAPTER 5. Selected Common Tasks	5-1
Section I. COMMUNICATIONS	5-1
113-571-1022 Perform Voice Communications	5-1
Section II. NAVIGATION	5-9
071-329-1001 Identify Terrain Features on a Map	5-9
071-329-1002 Determine the Grid Coordinates of a Point on a Military Map	5-17
071-329-1003 Determine a Magnetic Azimuth Using a Lensatic Compass	5-25
071-329-1008 Measure Distance on a Map	5-31

Section III. WEAPONS	5-35
M16A2 Rifle	5-35
071-311-2025 Maintain an M16A2 Rifle	5-35
071-311-2026 Perform a Function Check on an M16A2 Rifle	5-51
071-311-2027 Load an M16A2 Rifle	5-54
071-311-2028 Unload an M16A2 Rifle	5-59
071-311-2029 Correct Malfunctions of an M16A2 Rifle	5-60
NTN Routine Preventive Maintenance Checks and Services of the M16A2 Rifle	5-62
NTN Marksmanship Fundamentals	5-65
NTN Firing Positions	5-75
NTN Position of the Coach	5-78
NTN Checklist for the Coach	5-79
071-311-2030 Zero an M16A2 Rifle	5-80
M249 Squad Automatic Weapon	5-88
Clearing Procedures	5-89
Load an M249 SAW	5-90
Unload an M249 SAW	5-92
Correct Malfunctions of an M249 SAW	5-93
Hand Grenades	5-95
071-325-4401 Perform Safety Checks on Hand Grenades ...	5-95
071-325-4407 Employ Hand Grenades	5-99
M18A1 Claymore Mine	5-101
071-325-4425 Employ an M18A1 Claymore Mine	5-101
071-325-4426 Recover an M18A1 Claymore Mine	5-113
M203 Grenade Launcher	5-115
071-311-2127 Load an M203 Grenade Launcher	5-116
017-311-2128 Unload an M203 Grenade Launcher	5-118
M136 AT4 Light Antiarmor Weapon	5-119
071-054-0001 Prepare an M136 Launcher for Firing	5-121
071-054-0003 Perform Misfire Procedures on an M136 Launcher	5-128
071-054-0002 Restore an M136 Launcher to Carrying Configuration	5-130

Section IV. INDIVIDUAL SKILLS	5-131
NTN Cover, Concealment and Camouflage,.....	5-131
NTN Operate as a Member of a Squad	5-142
NTN Foot Marches	5-152
NTN Fighting Positions	5-164
NTN Bayonet/Combatives Fighting	5-172
NTN Rifle with Fixed Bayonet	5-187
Section V. TACTICAL SKILLS	5-194
301-348-1050 Report Information of Potential Intelligence Value (SALUTE Report)	5-194
071-326-0502 Move Under Direct Fire	5-198
071-326-0511 React to Flares	5-207
071-331-0801 Challenge Persons Entering Your Area	5-208
Section VI. NUCLEAR, BIOLOGICAL, CHEMICAL	5-210
NTN Standardized MOPP Levels	5-211
031-503-1014 Detect Chemical Agents Using M8 or M9 Detector Paper	5-213
031-503-1018 React to a Nuclear Hazard	5-217
031-503-1019 React to Chemical or Biological Hazard or Attack	5-223
031-503-1024 Replace Canister on Your M40-Series Protective Mask	5-227
031-503-1025 Protect Yourself from Chemical and Biological Injury or Contamination Using Your M40-Series Protective Mask with Hood	5-229
031-503-1026 Maintain Your M40-Series Protective Mask with Hood	5-240
031-503-1033 Decontaminate Your Skin Using the M291 Skin Decontaminating Kit (SDK)	5-250
031-503-1034 Decontaminate Your Individual Equipment Using the M295 Individual Equipment Decontamination Kit (IEDK)	5-256
Section VII. FIRST AID	5-261
081-831-1000 Evaluate a Casualty	5-261

NTN Perform First Aid to Restore Breathing	5-269
NTN Perform First Aid to Control Bleeding	5-281
081-831-1007 Perform First Aid for Treatment of Burns	5-299
081-831-1034 Perform First Aid for Splinting a Fracture	5-303
081-831-1053 Perform First Aid and Practice Individual Preventive Medicine Countermeasures	5-311
081-831-1044 Perform First Aid for Nerve Agent Injury	5-341
081-831-1046 Perform First Aid and Transporting Casualties	5-352

Appendix

A. Quotations	A-1
B. Historic Documents	B-1
Extract from the Declaration of Independence	B-1
Preamble to the Constitution of the United States	B-3
C. National Anthem and Pledge of Allegiance	C-1
D. Army Song	D-1
E. Soldier's Code	E-1
F. Soldier's Responsibilities	F-1
G. General Orders	G-1
H. Code of Conduct	H-1
I. Benefits	I-1
Health/TRICARE	I-1
Legal	I-3
Personal & Family	I-4
Army Family Team Building (AFTB)	I-7
J. Promotions	J-1
K. Managing Personal Finances	K-1
L. Explanation of the Leave and Earnings Statement	L-1
M. Common Military Acronyms and Abbreviations	M-1

CHAPTER 1

GENERAL SUBJECTS

ARMY HISTORY

“Resolved, That a General be appointed to command all the continental forces, raised, or to be raised, for the defence of American liberty.” The above resolution of the Second Continental Congress on 14 June 1775 established the beginnings of the United States Army as we know it today. The very next resolution unanimously selected George Washington as commanding general of the first Continental Army.

From Lexington to Trenton to Valley Forge, the Continental Army proved the critical force in fighting and winning the war for American Independence (See Appendix B – Declaration of Independence). The Army has been the keeper of American freedom ever since.

From the outset, civilian control of the military was a governing principle of the American system. In 1787, the Constitution placed the military under the control of the President. His role as commander-in-chief requires every soldier to follow and obey his orders (See Appendix F – Soldier Responsibilities).

In 1789, Congress created the Department of War to administer the military forces. The Army, now under the direction of the newly created cabinet, remained at a strength of 60,000 or less from the end of the Revolution through the beginning of the Civil War. Although Congress

intended that the Regular Army serve only as a supplement to local militias, the “regulars” ultimately played the crucial role in both the War of 1812 and the Mexican War (1846-48).

In December of 1860, the Army consisted of merely 16,000 officers and enlisted men. By 1865, Civil War expansion had increased that number to an astounding 1,000,000. Victory for the Union in the Civil War returned the Army to a strength of only 25,000 troops.

An analysis of the Army’s role in the Spanish-American War (1898) revealed deficiencies in the War Department. After becoming Secretary of War in 1899, Elihu Root reorganized and revitalized the department. By the time the Army entered World War I in 1917, it was at its peak in terms of training and professionalism. Over 2,000,000 men followed General John J. Pershing to France as part of the American Expeditionary Force.

Following victory in the “War to End All Wars,” the Army remained at a strength of approximately 125,000 from 1919 to 1939. However, when Nazi Germany invaded France in 1940, the U.S. Government re-instituted conscription (the draft) and forces ballooned to 1,640,000.

Japan attacked Pearl Harbor on 7 December 1941 and during the early 1940s, 8,300,000 men and women were part of a global effort to claim victory in World War II. From the Pacific Theater and bloody battles in the Philippines to the D-Day invasion of Normandy on 6 June

1944, American forces fought with courage to preserve freedom for the world.

Following the fall of the Nazis and the surrender of the Japanese in August 1945, the Army again contracted – this time to a strength of approximately 500,000.

Expansions followed during America’s participation in the Korean and Vietnam Wars. And though it reduced in size during the interim periods of peace, the Army still remained relatively large due to the looming presence of the Cold War.

When the forces of Communism fell in the late 1980s, civilian leaders began to re-evaluate the Army’s role and it again went through a dramatic reduction in size.

Recently, the Army claimed a major victory in Desert Storm, defeating the 4th-largest enemy in the world in 100 hours. The Army has also had a crucial role in bringing peace to several areas of conflict as well as continuing to protect and advance American interests. No matter how the Army changes, or what the specific mission may be, the soldier’s role never changes: to support and defend the Constitution of the United States against all enemies, foreign and domestic.

HERITAGE AND TRADITIONS

The Army Song

"The Army Goes Rolling Along" is the official Army song (See Appendix D). It is proper to stand at attention when it is played. Known originally as the “Caisson Song”, the music was composed in 1908 by Lieutenant Edmund L. Gruber (who eventually rose to the rank of

brigadier general). The Army dedicated it as the official Army Song on 11 November 1956 – Veteran’s Day.

Uniforms

Historically, military uniforms have made it easier to identify units. Until the nineteenth century, different military organizations used brightly-colored clothing to distinguish themselves on the battlefield. This made it easier for a commander to control his forces. As weapons have become more lethal, survivability has become more crucial. Today, American military uniforms emphasize protective coloration. However, the Army has maintained the heritage of historical uniforms through more formal attire such as Dress Blues.

Formations

Similar to uniforms, formations have their roots in organizing fighting units so that a commander could exercise control of his forces. The Greek Phalanx was one of the earliest formations and achieved the effects of massing combat power with shields and swords, organizing movement, and establishing camaraderie. Napoleon is probably the most notable historical figure who mastered the use of Phalanx-like formations. Like uniforms, however, new weaponry forced a change in tactics. Modern-day formations, such as the wedge, emphasize survivability and maneuver – as opposed to sheer mass. The Army carries on the traditions of Napoleonic formations in the form of drill and ceremony.

Organizational Flags and Guidons

Every military unit has its own colors. Colors represent the heart of a unit and are always located with the commander. Units receive streamers for their



achievements that are then attached to their guidon above the colors. Capturing a unit's colors represents defeating that unit; in recent history a unit would fight to the death to protect its colors. The image of the American Flag accompanying General George Washington as he crosses the Delaware River signifies the importance of colors on the battlefield – from the nation's symbol down to the company guidon.

ARMY ORGANIZATION

The United States Army is made up of two parts: the active and reserve components. The Active Component consists of soldiers who are on full-time active duty. The Reserve Component consists of the Army National Guard and the Army Reserve. The Reserve Component receives

military training and is ready to be called to active duty if necessary. Army units can be organized several ways, but the following example is fairly typical:

- The **squad** is the smallest unit, consisting of eight to ten soldiers. The squad leader is a Noncommissioned Officer (NCO).
- The **platoon** includes the platoon leader (2LT/1LT), platoon sergeant (SFC) and two or more squads.
- The **company** includes the company commander (CPT), first sergeant (1SG) a headquarters, and two or more platoons.
- The **battalion** includes the battalion commander (LTC), his staff and headquarters, the command sergeant major (CSM) and approximately 3-5 companies.
- The **brigade** includes the brigade commander (COL), command sergeant major, a headquarters, and approximately 3-6 battalions.
- The **division** structure is the capstone element of our Army. It includes three maneuver (armor or infantry) brigades as well as several combat support and service support brigades or battalions. There are currently 10 active divisions, each commanded by a major general (two-stars):

- 1st Infantry Division – Germany (HQ)
- 2nd Infantry Division – Korea
- 3rd Infantry Division – Ft. Stewart, GA (HQ)
- 4th Infantry Division – Ft. Hood, Texas (HQ)
- 10th Mountain Division – Ft. Drum, New York
- 25th Infantry Division – Hawaii
- 82nd Airborne Division – Ft. Bragg, N. Carolina
- 101st Airborne Division – Ft. Campbell, KY
- 1st Armored Division – Germany (HQ)
- 1st Cavalry Division, Ft. Hood, Texas

- Organizations higher than the division include the Corps, Army, Major Command (MACOM), and in times of war, the Theater.

Chain of Command and NCO Support Channel

Your chain of command has legal responsibility for your training, discipline, and overall welfare. It includes the noncommissioned officer directly over you (your first-line supervisor), as well as officers and civilians from your company commander to the President of the United States. The NCO support channel, while not directly a part of your chain of command, is often just as important, and includes the noncommissioned officers (PSG, 1SG, CSM) who play a vital role in whatever unit you are a part of.

My Chain of Command

First Line Supervisor _____
 Company Commander _____

Battalion Commander _____
Brigade Commander _____
Division/Post Commander _____
TRADOC Commander _____
Chief of Staff of the Army _____
Secretary of the Army _____
Secretary of Defense _____
President of the United States _____

My NCO Support Channel

Platoon Sergeant _____
First Sergeant _____
Battalion CSM _____
Brigade CSM _____
Division/Post CSM _____
TRADOC CSM _____
Sergeant Major of the Army _____

RANK INSIGNIA

You must be able to recognize the ranks of Army personnel immediately.

Officer

The highest officer rank is the five-star general (General of the Army) and the lowest is the second lieutenant. Figure 1-1 shows the ranks with their insignia.

Address all personnel with the rank of general as "*General (last name)*" regardless of the number of stars.

Likewise, address both colonels and lieutenant colonels as "*Colonel (last name)*" and first and second lieutenants as "*Lieutenant (last name)*."

Address warrant officers as "*Mr. (last name)*" or "*Ms. (last name)*." Figure 1-2 shows the five warrant officer ranks.

Figure 1-1. Officer insignia.

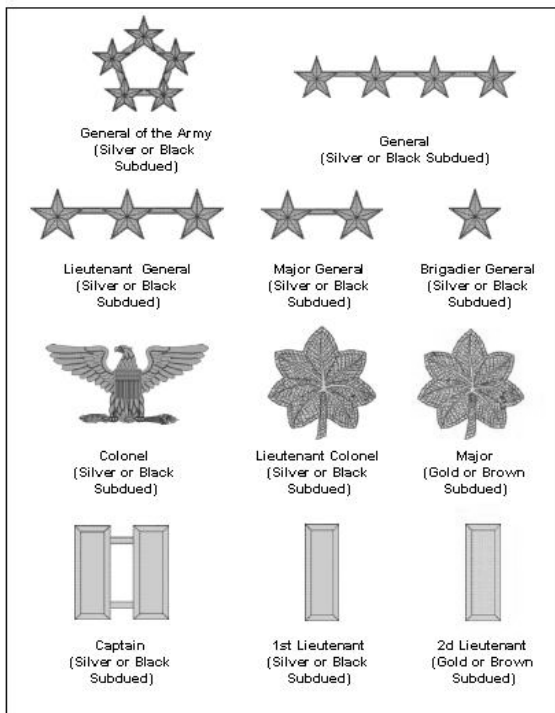
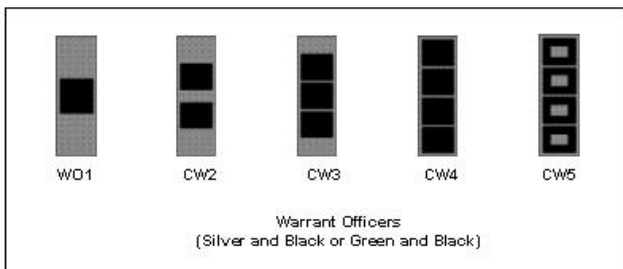

Figure 1-2. Warrant officer insignia.



Enlisted

Enlisted ranks range from private to sergeant major (grades E1 to E9) of the Army. Figure 1-3, shows the enlisted ranks with their insignia.

Address privates (E1 and E2) and privates first class (E3) as "*Private (last name)*." Address specialists as "*Specialist (last name)*." Address sergeants, staff sergeants, sergeants first class, and master sergeants as "*Sergeant (last name)*." Address first sergeants as "*First Sergeant (last name)*" and sergeants major as "*Sergeant Major (last name)*."

Figure 1-3. Enlisted insignia.

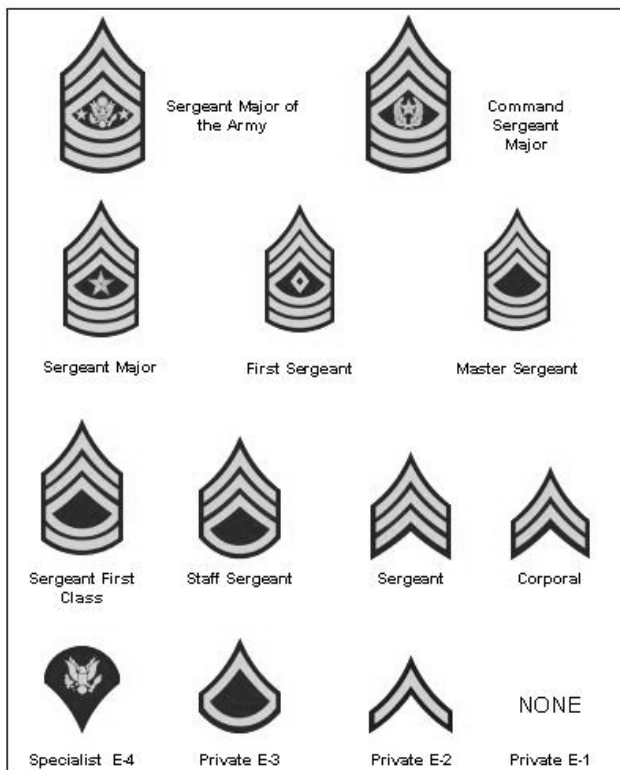

Rank Abbreviations

2LT – Second Lieutenant
1LT – First Lieutenant
CPT – Captain
MAJ – Major
LTC – Lieutenant Colonel
COL – Colonel
BG – Brigadier General
MG – Major General
LTG – Lieutenant General
GEN – General
PVT – Private
PV2 – Private Second Class
PFC – Private First Class
SPC – Specialist
CPL – Corporal
SGT – Sergeant
SSG – Staff Sergeant
SFC – Sergeant First Class
MSG – Master Sergeant
1SG – First Sergeant
SGM – Sergeant Major
CSM – Command Sergeant Major

MILITARY TIME

All US military services tell time by using the numbers "1" to "24" for the 24 hours in a day. A day begins at one minute after midnight and ends at midnight the same day. For example, eight minutes after midnight (12:08 am) is written in military time as "0008."

Thirty-three minutes after two o'clock in the afternoon (2:33 pm) is written as "1433."

Figure 1-4, shows a time conversion chart.

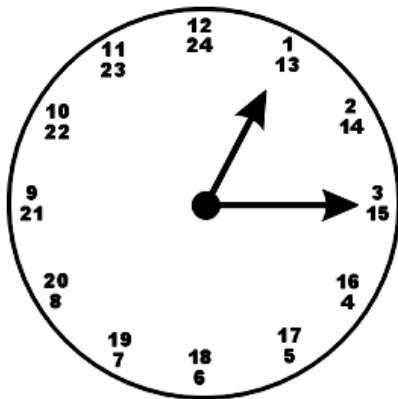

Figure 1-4. Time conversion chart.

CIVILIAN TIME	MILITARY TIME	CIVILIAN TIME	MILITARY TIME
12:01 am	0001		
1:00 am	0100	1:00 pm	1300
2:00 am	0200	2:00 pm	1400
1:00 am	0300	3:00 pm	1500
4:00 am	0400	4:00 pm	1600
5:00 am	0500	5:00 pm	1700
6:00 am	0600	6:00 pm	1800
7:00 am	0700	7:00 pm	1900
8:00 am	0800	8:00 pm	2000
9:00 am	0900	9:00 pm	2100
10:00 am	1000	10:00 pm	2200
11:00 am	1100	11:00 pm	2300
12:00	1200	12:00	2400
NOON		MIDNIGHT	

CUSTOMS AND COURTESIES

Saluting

The origin of the hand salute is uncertain. Some historians believe it began in late Roman times when assassinations were common. A citizen who wanted to see a public official had to approach with his right hand raised to show that he did not hold a weapon. Knights in armor raised visors with the right hand when meeting a comrade. This practice gradually became a way of showing respect and, in early American history, sometimes involved removing the hat. By 1820, the motion was modified to touching the hat, and since then it has become the hand salute used today.

During your time in the Army, you salute to show respect toward an officer, flag, or our country. The proper way to salute with or without a weapon is described in FM 22-5. The rules of saluting are as follows:

- When you meet someone outside, salute as soon as you recognize that he or she is an officer (or, if you are walking toward the officer, wait until you are about six steps away).
- Salute all officers (recognized by rank) in official vehicles identified by special plates or flags.
- Salute only on command when in formation.

- If in a group, and an officer approaches, the first soldier to recognize the officer calls the group to attention and all personnel salute.
- If you approach an officer while you are double-timing alone, assume quick time march and render the hand salute. When the salute is returned, execute order arms and resume double-timing.
- The salute is always initiated by the subordinate and is terminated only after acknowledgment by the individual being saluted.
- Accompany the salute with an appropriate greeting, such as, "*Good morning/afternoon, sir/ma'am.*"
- Salutes are not required to be rendered by or to personnel who are driving or riding in privately owned vehicles.
- It is not customary for enlisted personnel to exchange salutes, except in some ceremonial situations.
- Never render a salute with a noticeable object in your mouth or right hand.
- If you are on detail, and an officer approaches, salute if you are in charge of the detail. Otherwise, continue to work. If you are spoken to, then come to the position of attention.

Rendering Honor to the Flag

The flag of the United States is the symbol of our nation. The union, white stars on a field of blue, is the honor point of the flag. The union of the flag and the flag itself, when in company with other flags, are always given the honor position, which is on the right. Rules for displaying the flag follows:

- The flag of the United States will be displayed outdoors at all Army installations.
- Only one flag of the United States will be flown at one time at any continental United States (CONUS) Army installation except as authorized by the commanding generals of major Army commands.
- The flag will be displayed daily from reveille to retreat. If illuminated, it may be displayed at night during special events or on special occasions deemed appropriate by the commander.
- The flag of the United States is the only flag that may be flown from a flagpole over an Army installation. An exception is the Minuteman flag that, if awarded, may be flown beneath the flag of the United States.
- In unusual circumstances not covered in the Army regulations, the judgment of the senior Army individual present will be used to determine whether the flag shall be displayed on a specific occasion.

When the flag is being raised in the morning or lowered in the evening, you should stand at attention on the first note of Reveille or "To the Colors." ("Colors" refer to the flag of the United States and can also include the unit flag.) Give the required salute. If you are involved in some duty that would be hampered by saluting, you do not need to salute. You normally face the flag when saluting, unless duty requires you to face in some other direction. At the conclusion of the ceremony, resume your regular duties.

Whenever Reveille is played, and you are not in formation and not in a vehicle, come to attention at the first note, face the flag, and give the required salute. If no flag is near, face the music and salute. If you are in formation, salute only on the order "*Present arms.*" If you are in civilian clothing, stand at attention and place your right hand over your heart. These honors also apply to the national anthems of foreign countries during ceremonies or parades. The words to the National Anthem are shown in Appendix C.

Vehicles in motion should stop. If you are in a car or on a motorcycle, dismount and salute. If you are with a group in a military vehicle or bus, remain in the vehicle. The individual in charge will dismount and salute.

When you are passing or being passed by colors which are being presented, paraded, or displayed, salute when the colors are six paces from you. Hold the salute until the colors are six paces beyond you.

Courtesies

The following rules will help you conduct yourself appropriately in the presence of officers and anyone senior to you in rank:

- When talking to an officer, stand at attention unless given the order "*At ease*." When you are dismissed, or when the officer departs, come to attention and salute.
- When an officer enters a room, the first soldier to recognize the officer calls personnel in the room to attention but does not salute. A salute indoors is rendered only when one is reporting.
- When accompanying a senior, walk on his left.
- When entering or exiting a vehicle, the junior ranking person is the first to enter, and the senior in rank is the first to exit.
- When an officer enters a dining facility, unless he directs otherwise or unless a more senior officer is already present, the diners will be given the order "*At ease*" by the first person who sees the officer. You will remain seated at ease and will continue eating unless the officer directs otherwise. If you are directly addressed, you should rise to attention if seated in a chair. If you are seated on a bench, stop eating and sit at attention until the conversation is ended.

Note: The officer or NCO may give the directive "*Carry on.*" This means the soldier or soldiers should continue with whatever they were doing previously.

This same directive may be used in many other situations outside of formation, such as in the barracks and break areas.

- When outdoors and approached by an NCO, you should stand (if seated) and greet the NCO by saying, "*Good morning, sergeant,*" "*Good afternoon, sergeant,*" or "*Good evening, sergeant (last name, if known).*"
- When you report to an officer for any reason, it is important to make a good first impression. If you are outdoors, approach the officer to whom you are reporting and stop about two steps from him, assuming the position of attention. Give the proper salute and say, for example, "*Sir/Ma'am, Private Smith reports.*" If you are indoors, use the same procedures as above, except remove your headgear before reporting. If you are armed, however, do not remove your headgear.

Role of the Chaplain

Each battalion in the Army has its own Chaplain (normally a CPT). The chaplain and his assistant formulate what is known as the Unit Ministry Team. The chaplain is responsible for providing spiritual support to every soldier in the unit. Although chaplains are part of a particular denomination, their mission is to ensure that

every soldier's spiritual needs are met.

Chaplains hold weekly services (both in garrison and in the field), are available for individual counseling, and are one of two members of the military who retain the privilege of confidentiality (the other being Army lawyers). The chaplain also plays a key role in helping promote programs such as suicide prevention.

In the IET environment, chaplains are of particular value in helping soldiers succeed under difficult and stressful conditions. They assist the commander in teaching, displaying, and instilling the Army Values and in maintaining high morale within the unit.

Each brigade (MAJ or LTC), division (LTC), and installation (COL) also has its own chaplain. The Chief of Chaplains is a Major General.

CHAPTER 2 ARMY VALUES

“Everywhere you look on the fields of athletic competition, in combat training, operations, and in civilian communities soldiers are doing what is right.”

Former Sergeant Major of the Army Julius W. Gates



LOYALTY. Bear true faith and allegiance to the U.S. Constitution, the Army, your unit, and other soldiers.

“Loyalty is the big thing, the greatest battle asset of all. But no man ever wins the loyalty of troops by preaching loyalty. It is given to him as he proves his possession of the other virtues.”

Brigadier General Samuel L.A. Marshall
Men Against Fire (1947)

Bearing true faith and allegiance is a matter of believing in, and devoting yourself to something or someone. A loyal soldier is one who supports the leadership and stands up for fellow soldiers. Wearing the uniform of the United States Army is a highly visible means of expressing your loyalty. You show your loyalty to your unit by doing your share. Any time you choose one individual's actions—right or wrong—over the safety and welfare of the rest of the unit, or over your own interest and commitment, you are eroding the value of loyalty.

To be *loyal* is to be unswerving in allegiance to the Constitution and completely faithful to the lawful government. Our absolute allegiance and faithfulness prevents us from misplacing our loyalties. Loyalty to the unit is critical for generating confidence and trust, and for developing cooperative work relationships with others.

A *loyal* individual does the following:

- Respects the Constitution and laws
- Puts obligations in correct order: the Constitution, the Army, the unit, and finally, self
- Observes higher Headquarters priorities
- Works within the system without manipulating it for personal advantage
- Shows faithfulness to unit and comrades
- Carries out tough orders without expressing personal criticism
- Defends soldiers against unfair treatment from outside or above

Since before the founding of the republic, America's Army has respected its subordination to its civilian political leaders. This subordination is fundamental to preserving the liberty of all Americans. You began your Army career by swearing allegiance to the Constitution which designates the president as commander in chief.

Beyond your allegiance to the Constitution, you have an obligation to be faithful to the Army, the institution and its people, and to your unit or organization. Few examples illustrate loyalty to country and institution as well as the example of General George Washington in 1782.

***GEN George Washington at Newburgh, New York
(The Newburgh Conspiracy)***

Following its victory at Yorktown in 1781, the Continental Army set up camp at Newburgh, New York, to wait for peace with Great Britain. The central government formed under the Articles of Confederation proved weak and unwilling to supply the Army properly or even pay the soldiers who had won the war for independence. After months of waiting, many officers, angry and impatient, suggested that the Army march on the seat of government in Philadelphia, Pennsylvania, and force Congress to meet the Army's demands. One colonel even suggested that General Washington become King George I.



Upon hearing this, General Washington assembled his officers and publicly and emphatically rejected the suggestion. He believed that seizing power by force would have destroyed everything for which the Revolutionary War had been fought. By this action, General Washington firmly established an enduring precedent: America's armed forces are subordinate to civilian authority and serve the democratic principles that are now enshrined in the Constitution. His action demonstrated the loyalty to country that America's

Army must maintain in order to protect the freedom enjoyed by all Americans.

DUTY. Fulfill your obligations.

“The essence of duty is acting in the absence of orders or direction from others, based on an inner sense of what is morally and professionally right.”

General John A. Wickham
Former Army Chief of Staff

Duty delineates the sum total of all laws, rules, etc., that make up our organizational, civic, and moral obligations. Our values originate with duty because, at a minimum, we expect all members of the Army to fulfill their obligations. We often expect individuals to exceed their duty, especially in ethical matters. The nation's highest award, the Medal of Honor, imparts the notion of an individual acting "above and beyond the call of duty." Doing your duty means more than carrying out your assigned tasks. The work of the United States Army is a complex combination of missions, tasks, and responsibilities—all in constant motion. And the work, inevitably, is a matter of building one assignment or task on work that has been done previously. Doing your duty is a very important responsibility.

Duty also means being able to accomplish tasks as part of a team. You must fulfill your obligations as a part of your unit. Examples include: voluntarily assuming your share of the work load, willingly serve as a member of a team, or assuming a leadership role when appropriate.

You demonstrate the value of duty when you complete a task even when no one is looking, or when you resist the temptation to take "shortcuts" that might undermine the integrity of the final product. You do your duty as a soldier every time you do something that needs to be done — without being told.

An individual who expresses the value of *duty* will, at a minimum, do the following:

- Carry out requirements of job/office
- Fulfill legal, civic, and moral obligations
- Sacrifice personal time in pursuit of excellence

Duty begins with everything required of you by law, regulation, and orders; but it includes much more than that. Professionals do their work not just to the minimum standard, but also to the very best of their ability. Soldiers and DA civilians commit to excellence in all aspects of their professional responsibility so that when the job is done they can look back and say, "I could not have given any more."

Duty in Korea

CPT Viola B. McConnell was the only Army nurse on duty in Korea in July of 1950. When hostilities broke out, she escorted nearly 700 American evacuees from Seoul to Japan aboard a freighter designed to accommodate only 12 passengers. CPT McConnell assessed priorities for care of the evacuees and worked exhaustively with a medical team to care for them. Once in Japan, she requested reassignment back to Korea. After all she had already done, CPT McConnell returned to Taejon to care for and evacuate wounded soldiers of the 24th Infantry Division.

CPT McConnell understood and fulfilled her duty to the Army and to the soldiers she supported in ways that went beyond her medical training. Duty



isn't reserved for special occasions. When a platoon sergeant tells a squad leader to inspect weapons, the squad leader has fulfilled his minimum obligation when he has checked the weapons. He's done what he was told to do. But if the squad leader finds weapons that are not clean or serviced, his sense of duty tells him to go beyond the platoon sergeant's instructions. The squad leader does his duty when he corrects the problem and ensures the weapons are up to standard.

RESPECT. Treat people as they should be treated.

In the Soldier's Code, we pledge to "treat others with dignity and respect and expect others to do the same." Respect to a soldier simply means treating people as they should be treated. It means giving others the same consideration we would like or expect to be given.

"The discipline which makes the soldiers of a free country reliable in battle is not to be gained by harsh or tyrannical treatment. On the contrary, such treatment is far more likely to destroy than to make an army. It is possible to impart instruction and to give commands in such manner and such a tone of voice to inspire in the soldier no feeling; but an intense desire to obey, while the opposite manner and tone of voice cannot fail to excite strong resentment and a desire to disobey. The one mode or the other of dealing with subordinates springs from a corresponding spirit in the breast of the commander. He who feels the respect which is due to others cannot fail to inspire in them regard for himself, while he who feels, and hence manifests, disrespect toward others, especially his inferiors, cannot fail to inspire hatred against himself."

Major General John M. Schofield
Address to the United States Corps of Cadets
(1879)

The Army is one huge team, made up of hundreds of component parts. There must be connections — ground rules — so that when one soldier approaches, works with, or talks to another, it is with immediate and unquestioned cooperation and respect. The Army mirrors our country's diversity. Each of us has something to contribute. Respect is what allows us to appreciate the best in other people. Respect is trusting that all people have done their jobs—fulfilled their duty. Self-respect is a vital ingredient within the Army value of respect that results from knowing you have dug down deep to put forth your best effort.

Taking care of yourself physically shows your self-respect, keeping fit, not using drugs or tobacco products (smoking, chewing, and so forth). Finally, respect for other people includes not using profanity and obscene gestures. You are now in the military. What might have been acceptable in your civilian life may not be acceptable in the Army.

Respect is also an essential component for the development of disciplined, cohesive, and effective war fighting teams. In the deadly confusion of combat, soldiers often overcome incredible odds to accomplish the mission and protect the lives of their comrades. This spirit of selfless service and duty is built on a soldier's personal trust and regard for fellow soldiers.

A leader's willingness to tolerate discrimination or harassment on any basis, or a failure to cultivate a climate of respect, eats away at this trust and erodes unit cohesion. But respect goes beyond issues of discrimination and

harassment; it includes the broader issue of civility, the way people treat each other and those they come in contact with. It involves being sensitive to diversity and one's own behaviors that others may find insensitive, offensive, or abusive. Soldiers and DA civilians, like their leaders, treat everyone with dignity and respect.

An individual who consistently expresses *respect* does the following:

- Recognizes dignity of all
- Demonstrates consideration for others; is discreet and tactful when correcting or questioning others
- Is courteous and polite
- Demonstrates concern for safety and well-being of others
- Creates a climate of fairness
- Values diversity and is sensitive to diversity issues.
- Does not take advantage of position of authority when placed in charge of others

***Colonel Robert Gould Shaw and the 54th Massachusetts
Infantry Regiment
(Civil War – 1863)***



Robert Shaw was serving as a captain in the 2nd Massachusetts when Massachusetts Governor John Andrew selected him for a special assignment. Shaw was to muster and command the first regiment of African-American troops organized in a Northern state. On 18 Jul 1863, the regiment won undying glory by leading the bloody assault on Fort Wagner, South Carolina. In the attack, nearly half the regiment was killed, wounded, or captured. Colonel Shaw was among those who died. For his bravery in battle, Sergeant William H. Carney became the first African-American to earn the Medal of Honor.

The example of steadfast courage and heroism set by the 54th Massachusetts paved the way for the enlistment of over 200,000 African-Americans in the Union Army and Navy.



Colonel Shaw and the soldiers of the 54th Massachusetts believed that a person should be able to fight for his country and be judged on his ability to soldier rather than be judged by the color of his skin.

SELFLESS SERVICE. Put the welfare of the Nation, the Army, and your subordinates before your own.

In serving your country, you are doing your duty loyally, without thought of recognition or gain. The reward of selfless service is the satisfaction of a job well done—a successful accomplishment that reflects on the soldier and his or her unit. The greatest means of accomplishing selfless service is to dedicate yourself to the teamwork which is the

“The nation today needs men who think in terms of service to their country and not in terms of their country’s debt to them.”

General Omar N. Bradley
Former General of the Army

underlying strength of the Army. It is when thousands of soldiers work together as a team that spectacular results arise. The basic building block of selfless service is the commitment of each team member to go a little further, endure a little longer, and look a little closer to see how he or she can add to the effort of the unit, platoon, or company. Selfless service is larger than just one person. With dedication to the value of selfless service, each and every soldier can rightfully look back and say, "I am proud to have served my country as a soldier."

Selfless-service signifies the proper ordering of priorities. Think of it as service before self. The welfare of the nation and the organization come before the individual. While the focus is on

service to the nation, the value also requires that the service member properly take care of family and self.

An individual who properly demonstrates the value of *selfless service* does the following:

- Focuses priorities on service to the Nation
- Places needs of the Army above personal gain
- Ensures that soldiers' needs are met before attending to personal needs
- Balances mission, family, and personal needs
- Gives credit due others and accepts blame for the team

CPL HIROSHI H. MIYAMURA
Medal of Honor, 1951



Corporal, U.S. Army, Company H, 7th Infantry Regiment, 3rd Infantry Division. Awarded the Medal of Honor for his actions near Taejon-ni, Korea, 24 and 25 April 1951.

On the night of 24 April, Company H was occupying a defensive position when the enemy fanatically attacked threatening to overrun the position. Cpl. Miyamura, a machinegun squad leader, aware of the imminent danger to his men unhesitatingly

jumped from his shelter wielding his bayonet in close hand-to-hand combat killing approximately 10 of the enemy. Returning to his position, he administered first aid to the wounded and directed their evacuation. As another savage assault hit the line, he manned his machinegun and delivered withering fire until his ammunition was expended. He ordered the squad to withdraw while he stayed behind to render the gun inoperative. He then bayoneted his way through infiltrated enemy soldiers to a second gun emplacement and assisted in its operation.

When the intensity of the attack necessitated the withdrawal of the company, Cpl. Miyamura ordered his men to fall back while he remained to cover their movement. He killed more than 50 of the enemy before his ammunition was depleted and he was severely wounded. He maintained his magnificent stand despite his painful wounds, continuing to repel the attack until his position was overrun. When last seen he was fighting ferociously against an overwhelming number of enemy soldiers. Cpl. Miyamura's indomitable heroism and consummate devotion to duty reflect the utmost glory on himself and uphold the illustrious traditions on the military service.

HONOR. Live up to all the Army values.

“What is life without honor? Degradation is worse than death.”

Lieutenant General
Thomas J. “Stonewall” Jackson

When we talk about "living up to" something, we mean being worthy of it. We must make choices, decisions, and actions based on the Army core values. Nowhere in our values training does it become more important to emphasize the difference between "knowing" the values and "living" them than when we discuss the value of honor. Honor is a matter of carrying out, acting, and living the values of respect, duty, loyalty, selfless service, integrity, and personal courage in everything you do.

Noticing a situation and deciding to take action to assist another involves respect, duty, and honor. It was a matter of honor that soldiers, at great risk to themselves, distributed food in Somalia and kept the peace in Bosnia, while managing to protect the communities. There are hundreds of examples of soldiers who have distinguished themselves with honorable actions and lives. The Nation's highest military award is named "The Medal of Honor." This award goes to soldiers who make honor a matter of daily living—soldiers who develop a habit of being honorable, and solidify that habit with every value choice they make.

An individual with *honor* does the following:

- Adheres to a public code of professional Army values
- Identifies with the public code of professional Army values

***MSG Gary Gordon and SFC Randall Shughart
(Mogadishu, Somalia)***

During a raid in Mogadishu in October 1993, MSG Gary Gordon and SFC Randall Shughart, leader and member of a sniper team with Task Force Ranger in Somalia, were providing precision and suppressive fires from helicopters above two helicopter crash sites. Learning that no ground forces were available to rescue one of the downed aircrews and aware that a growing number of enemy were closing in on the site, MSG Gordon and SFC Shughart volunteered to be inserted to protect their critically



wounded comrades. Their initial request was turned down because of the danger of the situation. They asked a second time; permission was denied. Only after their third request were they inserted.



MSG Gordon and SFC Shughart were inserted one hundred meters south of the downed chopper. Armed only with their personal weapons, the two NCOs fought their way to the downed fliers through intense small arms fire, a maze of shanties and shacks, and the enemy converging on the site. After MSG Gordon and SFC Shughart pulled the wounded from the wreckage,

they established a perimeter, put themselves in the most dangerous position, and fought off a series of attacks. The two NCOs continued to protect their comrades until

they had depleted their ammunition and were fatally wounded. Their actions saved the life of an Army pilot.

No one will ever know what was running through the minds of MSG Gordon and SFC Shughart as they left the comparative safety of their helicopter to go to the aid of the downed aircrew. The two NCOs knew there was no ground rescue force available, and They certainly knew there was no going back to their helicopter. They may have suspected that things would turn out as they did; nonetheless, they did what they believed to be the right thing.

They acted based on Army values, which they had clearly made their own: loyalty to their fellow soldiers; the duty to stand by them, regardless of the circumstances; the personal courage to act, even in the face of great danger; selfless service, the willingness to give their all. MSG Gary I. Gordon and SFC Randall D. Shughart lived Army values to the end; they were posthumously awarded Medals of Honor.

INTEGRITY. Do what's right, legally and morally.

"The American people rightly look to their military leaders not only to be skilled in the technical aspects of the profession of arms, but also to be men of integrity."

*General J. Lawton Collins
Former Army Chief of Staff*

When we say that someone has integrity, we mean that person respects the rules of an organization, the country, and life. Such persons can be counted on to do the right thing, live honestly, and relate to others without playing games or having false agendas. Integrity is a quality you develop by adhering to moral principles. It requires that we do and say nothing that deceives others. As your integrity grows, so does the trust others place in you. It's integrity that requires us to pay our debts on time, turn in items that someone else has lost, and follow rules as laid out in the law or in the code of human ethics and morality. The Soldier's Code says, "No matter what situation I am in, I will never do anything for pleasure, profit, or personal safety that will disgrace my uniform, my unit, or my country." The more choices you make based on integrity, the more this highly prized value will affect your relationships with family and friends, and, finally, your fundamental acceptance of yourself.

A soldier displays integrity when he or she:

- Always acts according to what he or she knows to be right, even at personal cost.
- Possesses a high standard of moral values and principles
- Shows good moral judgment and demonstrates consistent moral behavior
- Avoids the wrong and stands up for what is right

- Shows candor and fairness in evaluating subordinates' work
- Shows consistency between words and deeds
- Uses the authority and power that comes with rank to work for mission accomplishment or for soldiers instead of for personal or private gain
- Puts being right ahead of being popular or easy
- Abides by principles

SSG ROY P. BENAVIDEZ

Detachment B-56, 5th Special Forces Group, Republic of Vietnam

West of Loc Ninh on 2 May 1968

Master Sergeant (then Staff Sergeant) Roy P. Benavidez United States Army, who distinguished himself by a series of daring and extremely valorous actions while assigned to Detachment B56, 5th Special Forces Group (Airborne), 1st Special Forces, Republic of Vietnam. On the morning of 2 May 1968, a 12-man Special Forces Reconnaissance Team was inserted by helicopters in a dense jungle area west of Loc Ninh, Vietnam to gather intelligence information about confirmed large-scale enemy activity. This area was controlled and routinely patrolled by the North Vietnamese Army. After a short period of time on the ground, the team met heavy enemy resistance, and requested emergency extraction. Three

helicopters attempted extraction, but were unable to land due to intense enemy small arms and anti-aircraft fire.

Sergeant Benavidez was at the Forward Operating Base in Loc Ninh monitoring the operation by radio when these helicopters returned to off-load wounded crewmembers and to assess aircraft damage. Sergeant Benavidez voluntarily boarded a returning aircraft to assist in another extraction attempt. Realizing that all the team members were either dead or wounded and unable to move to the pickup zone, he directed the aircraft to a nearby clearing where he jumped from the hovering helicopter, and ran approximately 75 meters under withering small arms fire to the crippled team.

Prior to reaching the team's position he was wounded in his right leg, face, and head. Despite these painful injuries, he took charge, repositioning the team members and directing their fire to facilitate the landing of an extraction aircraft, and the loading of wounded and dead team members. He then threw smoke canisters to direct the aircraft to the team's position. Despite his severe wounds and under intense enemy fire, he carried and dragged half of the wounded team members to the awaiting aircraft. He then provided protective fire by running alongside the aircraft as it moved to pick up the remaining team members.

As the enemy's fire intensified, he hurried to recover the body and classified documents on



the dead team leader. When he reached the leader's body, Sergeant Benavidez was severely wounded by small arms fire in the abdomen and grenade fragments in his back. At nearly the same moment, the aircraft pilot was mortally wounded, and his helicopter crashed. Although in extremely critical condition due to his multiple wounds, Sergeant Benavidez secured the classified documents and made his way back to the wreckage, where he aided the wounded out of the overturned aircraft, and gathered the stunned survivors into a defensive perimeter. Under increasing enemy automatic weapons and grenade fire, he moved around the perimeter distributing water and ammunition to his weary men, reinstilling in them a will to live and fight.

Facing a buildup of enemy opposition with a beleaguered team, Sergeant Benavidez mustered his strength, began calling in tactical air strikes and directed the fire from supporting gunships to suppress the enemy's fire and so permit another extraction attempt. He was wounded again in his thigh by small arms fire while administering first aid to a wounded team member just before another extraction helicopter was able to land. His indomitable spirit kept him going as he began to ferry his comrades to the craft. On his second trip with the wounded, he received additional wounds to his head and arms before killing his adversary. He then continued under devastating fire to carry the wounded to the helicopter. Upon reaching the aircraft, he spotted and killed two enemy soldiers who were rushing the craft from an angle that prevented the aircraft door gunner from firing upon them. With little strength remaining, he made one last trip to the perimeter to ensure that all classified material had been collected or destroyed, and to bring in the remaining

wounded. Only then, in extremely serious condition from numerous wounds and loss of blood, did he allow himself to be pulled into the extraction aircraft. Sergeant Benavidez' gallant choice to join voluntarily his comrades who were in critical straits, to expose himself constantly to withering enemy fire, and his refusal to be stopped despite numerous severe wounds, saved the lives of at least eight men. His fearless personal leadership, tenacious devotion to duty, and extremely valorous actions in the face of overwhelming odds were in keeping with the highest traditions of the military service, and reflect the utmost credit on him and the United States Army.

PERSONAL COURAGE. Face fear, danger, or adversity (physical or moral)

“The concept of professional courage does not always mean being tough as nails either. It also suggests a willingness to listen to the soldier’s problems, to go to bat for them in a tough situation and it means knowing just how far they can go. It also means being willing to tell the boss when he’s wrong.”

*CSM William Connelly
Former Sergeant Major of the Army*

Personal Courage includes the notion of taking responsibility for decisions and actions. Additionally, courage involves the ability to

perform critical self-assessment, to confront new ideas, and to change. Leaders must make decisions that involve risk and often must take a stand in the face of ambiguity or adversity. Taking risks pertains to the battlefield in war, but more frequently occurs with your boss in peace.

A *courageous* soldier does the following:

- Controls fear in physical and moral contexts
- Takes responsibility for decisions and actions
- Accepts responsibility for his own mistakes and shortcomings
- Confronts problems directly and takes action based on what he believes is right, regardless of what others may think
- Speaks up for what he believes is important and then is gracious whether his ideas are accepted or rejected
- Reports on successes and failures with equal candor
- Puts them self on the line to deal with important problems
- Challenges others to make tough decisions

- Always shares mistakes if it will help the team improve

Personal courage has long been associated with our Army. Accounts of the dangers and hardships that soldiers face are legendary. Personal courage is not the absence of fear; rather, it is taking positive action in spite of the fear. It takes two forms: physical and moral.

Physical courage means overcoming fears of bodily harm and doing your duty. It's the bravery that allows a soldier to take risks in combat in spite of the fear of wounds or death. Physical courage is what gets the soldier at Airborne School out the aircraft door. It's what allows an infantryman to assault a bunker to save his buddies. With physical courage, it is a matter of enduring physical duress and, at times, risking personal safety.

In contrast, moral courage is the willingness to stand firm on your values, principles, and convictions, even when threatened. Moral courage is sometimes overlooked, both in discussions of personal courage and in routine, daily activities. Moral courage often expresses itself as candor. Candor means being frank, honest, and sincere with others while keeping your words free from bias, prejudice, or malice.

When considering personal courage, physical or moral, there is one important point to be made. Nowhere does the value say that fear must disappear—that you should not feel fear. Some great instances of courage are those carried

out by the soldiers who have never seen a battlefield. You can build up your personal courage by daily standing up for and acting upon the things that you know are right.

SSG CLIFFORD C. SIMS
Company D, 2d Battalion (Airborne), 501st Infantry,
101st Airborne Division
Near Hue, Republic of Vietnam, 21 February 1968

Company D was assaulting a heavily fortified enemy position concealed within a dense wooded area when it encountered strong enemy defensive fire. Once within the woodline, SSgt. Sims led his squad in a furious attack against an enemy force, which had pinned down the 1st Platoon and threatened to overrun it. His skillful leadership provided the platoon with freedom of movement and enabled it to regain the initiative.

SSgt Sims was then ordered to move his squad to a position where he could provide covering fire for the company command group and to link up with the 3d Platoon, which was under heavy enemy pressure. After moving no more than 30 meters SSgt Sims noticed that a brick structure in which ammunition was stocked was on fire. Realizing the danger, SSgt Sims took immediate action to move his squad from this position. Though in the process of leaving the area 2 members of his squad were injured by



the subsequent explosion of the ammunition, SSgt Sims' prompt actions undoubtedly prevented more serious casualties from occurring.

While continuing through the dense woods amidst heavy enemy fire, SSgt Sims and his squad were approaching a bunker when they heard the unmistakable noise of a concealed booby trap being triggered immediately to their front. SSgt Sims warned his comrades of the danger and unhesitatingly hurled himself upon the device as it exploded, taking the full impact of the blast. In so protecting his fellow soldiers, he willingly sacrificed his life. SSgt Sims' extraordinary heroism at the cost of his life is in keeping with the highest traditions of the military service and reflects great credit upon himself and the U.S. Army.

CHAPTER 3

STANDARDS OF CONDUCT

The Uniform Code of Military Justice (UCMJ)

Military discipline is founded upon self-discipline, respect for authority, and the embracing of the professional Army ethic with its supporting individual values. Military discipline is developed through individual and group training to create a mental attitude that will result in proper conduct and prompt obedience to lawful military authority. There are 3 basic rules:

- Don't break the rules (What are the rules?
Example - UCMJ, regulations)
- Take responsibility for your actions
- Keep your hands to yourself

While military discipline is the result of effective training, it affects every aspect of military life. It is a trait found in individuals and units that is manifested by

- Unit cohesion, bonding, and a spirit of teamwork;
- Smartness of appearance and action;
- Cleanliness and maintenance of dress, equipment, and quarters;
- Respect to seniors and mutual respect between senior and subordinate personnel;
- Prompt and willing execution of both the letter and the spirit of the legal orders of their lawful commanders; and

- Fairness, justice, and equity for all soldiers, regardless of race, religion, color, gender, or national origin.

The UCMJ applies to active duty service members:

- 24 hours a day/7 days a week
- Anywhere you are in the world
- After discharge, if discharge was obtained fraudulently
- After active duty status is terminated (for Reserve and National Guard soldiers)

In other words, it is your **duty** to abide by the laws and regulations governed by the UCMJ, 24 hours a day, 7 days a week, for as long as you are in the Army. All persons in the military service are required to strictly obey and promptly execute the legal orders of their lawful seniors. Laws and regulations are part of everyday life. The UCMJ gives us judicial authority, which is essential to the Army's ability in accomplishing its military mission. The UCMJ is the statute that prescribes criminal law for soldiers.

The UCMJ authorizes non-judicial punishment by commanders and judicial punishment by courts-martial (military courts). It also provides for the punishment of strictly military offenses. Military offenses are those not common in civilian law. Examples include failure to repair, absence without leave, disrespect to noncommissioned officers and commissioned officers, and disobedience of orders.

The principle that an accused is innocent until proven guilty applies to both nonjudicial punishment and courts-martial. You have the right to be informed of any charges against you, as well as the names of accusers and known witnesses. You also have -

- The right to remain silent. You do not have to say anything that could be used to convict you. Anything you say can be used as evidence against you.
- The right to a military lawyer, unless you wish to hire a civilian lawyer at your own expense.
- Protection against double jeopardy. If found innocent by court-martial, you cannot be tried again by a court-martial for the same crime.
- The right to sentence review. Higher authority automatically reviews a conviction received in the military. The sentence cannot be increased but may be left as it is or decreased.
- The right to a speedy public trial.
- The right to call witnesses favorable to you.
- The right to an interpreter if you do not fully understand the English language.
- The right—if you are an enlisted person - to have at least one-third enlisted court members.

- The right to be tried by a military judge alone rather than by a court-martial panel, unless the case is tried as a capital offense. If the soldier does not elect trial by military judge, a trial with members will automatically be afforded the soldier.
- The right to trial by court-martial. You may refuse Article 15 punishment and demand trial by court-martial.

PUNITIVE ARTICLES

The following list contains the descriptive title and general provisions of selected punitive articles of the UCMJ that commonly occur in the training environment:

1. **ARTICLE 83 - Fraudulent Enlistment, Appointment, or Separation.** Any soldier who -

a. Procures his own enlistment or appointment in the armed forces by knowingly false representation or deliberate concealment as to his qualifications for that enlistment or appointment and receives pay and allowances there under, or

b. Procures his own separation from the armed forces by knowingly false representation or deliberate concealment as to his eligibility for that separation; shall be punished as a court-martial may direct.

2. **ARTICLE 86 - Absent Without Leave (AWOL).** Any soldier who, without authority -

a. Fails to go to his appointed place of duty at the time prescribed;

b. Goes from that place; or

c. Absents himself or remains absent from his unit, organization, or place of duty at which he is required to be at the time prescribed; shall be punished as a court-martial may direct.

3. ARTICLE 89 - Disrespect Toward A Superior Commissioned Officer. Any soldier who behaves with disrespect toward his superior commissioned officer shall be punished as a court-martial may direct. Disrespectful behavior is that which detracts from the respect due the authority of a superior commissioned officer or noncommissioned officer. It may consist of :

a. Acts or language;

b. Abusive epithets or other contemptuous or denunciatory language;

c. Neglecting the customary salute; or

d. Showing marked disdain, indifference, insolence, impertinence, undue familiarity, or other rudeness in the presence of the superior.

4. ARTICLE 90 - Assaulting or Willfully Disobeying Superior Commissioned Officer. Any soldier who -

a. Strikes his superior commissioned officer or draws or lifts up any weapon or offers any violence against him while he is in the execution of his office; or

b. Willfully disobeys a lawful command of his superior commissioned officer shall be punished, if the offense is committed in time of war, by death or such other punishment as a court-martial may direct, and if the offense is committed at any other time, by such punishment, other than death.

5. ARTICLE 91 – Insubordinate Conduct Toward Warrant Officer, Noncommissioned Officer, or Petty Officer. Any soldier who -

a. Strikes or assaults a warrant officer, noncommissioned officer, or petty officer, while that officer is in the execution of his office;

b. Willfully disobeys the lawful order of a warrant officer, noncommissioned officer, or petty officer; or

c. Treats with contempt or is disrespectful in language or deportment toward a warrant officer, noncommissioned officer, or petty officer while that officer is in the execution of his office; shall be punished as a court-martial may direct.

6. ARTICLE 92 – Failure to Obey Orders. Any soldier who -

a. Violates or fails to obey any lawful general order or regulation;

b. Having knowledge or any other lawful order issued by a member of the armed forces, which it is your duty to obey, fails to obey the order; or

c. Is derelict in the performance of his duties; shall be punished as a court-martial may direct.

7. ARTICLE 115 – Malingering. Any soldier who for the purpose of avoiding work, duty, or service -

a. Feigns illness, physical disablement, mental lapse or detriment; or

b. Intentionally inflicts self-injury; shall be punished as a court-martial may direct.

8. ARTICLE 121 – Larceny and Wrongful Appropriation. Any soldier who wrongfully takes, obtains, or withholds, by any means, from the possession of the owner or of any other person any money, personal property, or article of value of any kind

a. With intent permanently to deprive or defraud another person of the use and benefit of property or to appropriate it to his own use of the use of any person other than the owner, steals that property and is guilty of larceny; or

b. With intent temporarily to deprive or defraud another person of the use and benefit of property or to appropriate it to his own use or the use of any person other than the owner, is guilty of wrongful appropriation; shall be punished as a court-martial may direct.

9. ARTICLE 128 – Assault. Any soldier who -

a. Attempts or offers with unlawful force or violence to do bodily harm to another person, whether or not the attempt or offer is consummated, is guilty of assault and shall be punished as a court-martial may direct.

b. Commits an assault with a dangerous weapon or other means or force likely to produce death or grievous bodily harm; or

c. Commits an assault and intentionally inflicts grievous bodily harm with or without a weapon; is guilty of aggravated assault and shall be punished as a court-martial may direct.

10. ARTICLE 134 – General Article.

a. All disorders and neglects to the prejudice of good order and discipline in the armed forces;

b. All conduct of a nature to bring discredit upon the armed forces; and

c. Crimes and offenses not capital, of which persons subject to this chapter may be guilty, shall be taken

cognizance of by a general, special, or summarized court-martial according to the nature and degree of the offense, and shall be punished at the discretion of that court.

FORMS OF PUNISHMENT

The following are forms of punishment that may be imposed for violations of the UCMJ. All forms of punishment are subject to restrictions specified in the UCMJ. The UCMJ provides limitations of sentences based on the nature of the crime; the form of adjudication (nonjudicial punishment or court-martial); and the position/rank of the individual assigning the punishment or the type of court-martial that convicted the soldier.

1. *Reprimand.* The convening authority of a court-martial or commanding officer may punish a soldier by censure, or condemn as wrong. A reprimand is a severe form of censure that adversely reflects upon the conduct of the person addressed. A court-martial shall not specify the terms or wording of a reprimand. A reprimand, if approved, shall be issued, in writing, by the convening authority. A reprimand adjudged by a court-martial is a punitive censure.

2. *Forfeiture of pay and allowances.* A forfeiture deprives the individual accused, or all or a specific amount, of money to be accrued (earned in the future) as a result of service in the armed forces of the United States. Unless a total forfeiture is adjudged, a sentence to forfeiture shall state the exact amount in whole dollars to

be forfeited each month and the number of months the forfeitures will last.

3. *Fine.* A fine makes the accused immediately liable to the United States for the entire amount of money specified in the sentence. A fine may only be adjudged by a court-martial, and it may be adjudged instead of or in addition to forfeiture. However, a fine is normally used only as a sentence in cases where the accused was unjustly enriched as a result of the offense of which convicted.

4. *Reduction in pay grade.* Except as provided in R.C.M. 1301(d), a court-martial may sentence an enlisted member to be reduced to the lowest or any intermediate pay grade.

5. *Restriction to specified limits.* Restriction deprives the accused of normal liberty privileges. The sentence will specify the physical and geographic locations in which the individual is allowed, how long the restriction shall last, and when that individual must be present at specific locations.

6. *Hard labor without confinement.* Hard labor without confinement is performed in addition to other regular duties and does not excuse or relieve a person from performing regular duties. Ordinarily, the immediate commander of the accused will designate the amount and character of the labor to be performed.

7. *Confinement.* The place of confinement shall not be designated by the court-martial. A court-martial shall not

adjudge a sentence to solitary confinement or to confinement without hard labor. The authority executing a sentence to confinement may require hard labor whether or not the words "at hard labor" are included in the sentence.

8. *Punitive separation.* A court-martial may not adjudge an administrative separation from the service. There are three types of punitive separation.

a. *Dismissal.* Dismissal applies only to commissioned officers, commissioned warrant officers, cadets, and midshipmen and may be adjudged only by a general court-martial. Regardless of the maximum punishment specified for an offense in Part IV of this Manual; a dismissal may be adjudged for any offense of which a commissioned officer, commissioned warrant officer, cadet, or midshipman has been found guilty;

b. *Dishonorable discharge.* A dishonorable discharge applies only to enlisted persons and warrant officers who are not commissioned and may be adjudged only by a general court-martial. Regardless of the maximum punishment specified for an offense in Part IV of the Manual for Courts Martial; a dishonorable discharge may be adjudged for any offense of which a warrant officer who is not commissioned has been found guilty. A dishonorable discharge should be reserved for those who should be separated under conditions of

dishonor, after having been convicted of offenses usually recognized in civilian jurisdictions as felonies, or of offenses of a military nature requiring severe punishment; and

c. Bad conduct discharge. A bad-conduct discharge applies only to enlisted persons and may be adjudged by a general court-martial and by a special court-martial that has met the requirements of R.C.M. 201(F)(2)(B). A bad-conduct discharge is less severe than a dishonorable discharge and is designed as a punishment for bad-conduct rather than as a punishment for serious offenses of either a civilian or military nature. It is also appropriate for an accused who has been convicted repeatedly of minor offenses and whose punitive separation appears to be necessary.

9. *Death.*

COURTS-MARTIAL

There are three types of courts-martial: summary, special, and general. Trials by courts-martial are the military equivalents of trials by judges and juries. The differences among the three are based on their composition, level of authority, and severity of punishments authorized.

Summary Court-Martial. Composed of one commissioned officer on active duty with the rank of Captain or above. The purpose of the summary court-martial is to make thorough and impartial inquiries into

minor offenses and to make sure that justice is done, with the interests of both the government and the accused being safeguarded. Only enlisted personnel may be tried by summary court-martial. Anyone subject to summary court-martial may refuse to be tried by summary court-martial. Whether an offense is minor depends on several factors, including the nature and circumstances of the offense. Also considered is the age, rank, duty assignment, record, and experience of the accused. The maximum punishment that can be given by a summary court-martial to a soldier pay grade E4 or below is -

- Confinement at hard labor for one month.
- Forfeiture of two-thirds of a month's pay for one month.
- Reduction to the lowest enlisted grade.

Special Court-Martial. This court consists of a military judge and not less than three panel members when required. It is held for relatively serious offenses. The maximum punishment that can be given by a special court-martial is -

- Confinement at hard labor for six months.
- Forfeiture of two-thirds of a month's pay for six months.
- Reduction to the lowest enlisted grade.

Some special courts-martial are empowered to rule on a Bad Conduct Discharge. This punitive discharge deprives a soldier of many veterans' benefits.

General Court-Martial. This court consists of a military judge and not less than five panel members when required. It is held for serious offenses. A general court-martial may impose any authorized punishment including the death penalty in certain cases.

NONJUDICIAL PUNISHMENT

Under the provisions of the UCMJ, Article 15, commanding officers may impose nonjudicial punishment upon soldiers who commit minor offenses within their units. The purpose of nonjudicial punishment is to train, correct, and reform. It also promotes positive behavior changes in soldiers without the stigma of a court-martial conviction.

If you are the accused soldier, you have the option of either demanding trial by court-martial or accepting nonjudicial punishment.

Once your commanding officer has passed judgment and sentenced you, if you feel that the punishment awarded to you is unjust or disproportionate to the offense, you may appeal all or part of your sentence to the next higher authority. The appeal authority may set aside, decrease, suspend, or let stand any portion or the entire original sentence. However, he cannot in any way increase the original sentence.

Article 15. Article 15 of the UCMJ is a form of nonjudicial punishment that can be imposed by a commanding officer for a relatively minor offense. An Article 15 can be imposed upon any soldier who does not demand a court-

martial. There are two types of Article 15 proceedings: summarized and formal.

- *Summarized proceedings* may be used for very minor misconduct. The punishment should not exceed an oral reprimand, extra duty, restriction for 14 days, or any combination of these punishments.
- *Formal proceedings* begin with the initial notification and end with the appeals process. The maximum punishments for a soldier grade E4 and below by a field grade commander include a reprimand, extra duty for 45 days, restriction for 60 days, correctional custody for 30 days, loss of ½ pay per month for 2 months, rank reduction to one or more lower grades, or a combination of any of these punishments.

The Army's Equal Opportunity (EO) Program and Policy

The EO program ensures an Army-wide, concentrated effort to maximize human potential and to ensure fair treatment for all persons based solely on merit, fitness, and capability in support of readiness. The EO philosophy is based on fairness, justice, and equity.

The Army's EO program emphasizes fair and equal treatment. It provides equal opportunity and treatment for military personnel, civilians, and families without regard to *race, color, religion, gender, or national origin*. This policy applies -

- On and off post
- Extends to soldiers, civilian employees, and family members
- Includes working, living, and recreational environments

The EO complaints processing system addresses grievances that allege unlawful discrimination or unfair treatment on the basis of race, national origin, color, gender, and/or religious affiliation, or sexual harassment. Attempts should always be made to solve the problem at the lowest possible level within an organization.

If a complaint is submitted, it will be investigated. Those personnel found to be in violation of the EO Policy are subject to the punishment under the UCMJ.

EO Complaint Process

Individuals are encouraged to attempt to resolve their complaints by confronting the alleged offender or by informing other appropriate officials about the offensive behavior or other allegations of unequal or unfair treatment.

Individuals are responsible to advise their chain of command of the specifics of discrimination or sexual harassment and provide their chain of command the opportunity to take appropriate action to resolve the issue(s). All personnel must submit only legitimate complaints and should exercise caution against frivolous or reckless allegations.

The Army has two types of EO complaints within its EO complaint process. They are informal and formal.

- a. **Informal complaints.** An informal complaint is any complaint that a soldier, family member or DA civilian does not wish to file in writing. Informal complaints may be resolved directly by the individual, with the help of another unit member, the commander or other person in the complainant's chain of command. Typically, those issues that can be taken care of informally can be resolved through discussion, problem identification, and clarification of the issues. An informal complaint is not subject to time suspense nor is it reportable.
- b. **Formal complaints.** A formal complaint is one that a soldier, family member, or DA civilian files in writing and swears to the accuracy of the information. This form is available at your unit, selected agencies, and higher headquarters, or from installation commanders. Formal complaints require specific actions, are subject to timelines, and require documentation of the actions taken. An individual files a formal complaint using a DA Form 7279-R, Equal Opportunity Complaint Form.

Alternative Agencies.

Although handling EO complaints through the chain of command is strongly encouraged, this is not the only

channel. Should the soldier feel uncomfortable in filing a complaint with the chain of command, or should the complaint be against a member of the chain of command, there are a number of alternative agencies through which a complaint can be made.

The following are frequently used agencies:

- a. Equal Opportunity Adviser (EOA)
- b. Chaplain
- c. Provost Marshal
- d. Staff Judge Advocate
- e. Housing Referral Office
- f. Inspector General
- g. EO Hotline

The Right To Appeal

If the person filing the complaint perceives that the investigation failed to reveal all relevant facts to substantiate the allegations, or that the actions taken by the command on his or her behalf were insufficient to resolve the complaint, the complainant has the right to appeal to the next higher commander in his or her chain of command. The complainant may not appeal the action taken against the perpetrator, if any is taken.

The Military Whistleblowers Protection Act (MWPA)

The MWPA allows service members to make or prepare protected communications about unlawful conduct. In exchange for blowing the whistle on unlawful conduct, the

MWPA provides service members with remedies and a swift investigation of any reprisal.

The MWPA protects two categories of communications.

1. Individual, rather than collective, lawful communications between a service member and a member of Congress or an IG. The lawful communication does not have to involve an allegation of illegal conduct.
2. Communications that a service member reasonably believes allege illegal conduct. These include violations of law or regulation, reports of sexual harassment or discrimination, mismanagement, or gross waste of funds. They also include abuse of authority or actions that involve “a substantial and specific danger to public health or safety.”

The MWPA prohibits retaliation against a service member for “making or preparing” protected communications. This includes any good faith act by a service member to communicate with a statutorily recognized recipient that is short of actual communication. The MWPA prohibits any “person” from restricting or retaliating against a service member who lawfully communicates with Congress or an IG. The MWPA also prohibits any “person” from restricting or retaliating against a service member who communicates with statutorily recognized recipients about illegal activities.

FRATERNIZATION

Army Policy on Relationships Between Soldiers

The Army historically has relied upon custom and tradition to define the bounds of acceptable personal relationships among its members. Soldier relationships have always been judged with reference to customs and traditions of the service.

It is difficult to predict which relationships – strong friendships, parent-child, sibling, career, and business – can create adverse affects. The Army prohibits all unprofessional relationships that -

- Compromise the chain of command
- Cause partiality or unfairness
- Involve the improper use of rank for personal gain
- Are or perceived to be exploitive or coercive in nature
- Create an adverse impact on discipline, authority, morale, or mission accomplishment

Violations of the fraternization and improper relationships policy may be punished under Article 92, UCMJ, as a violation of a lawful general regulation.

The Army's fraternization policy prohibits personal relationships between officer and enlisted personnel regardless of their service. This policy applies to

different-gender relationships and same-gender relationships. Categories of personal relationships include

- Dating
- Shared living accommodations
- Engaging in intimate or sexual relations
- Business enterprises
- Commercial solicitations
- Gambling or borrowing

IMPROPER (“ILLEGAL”) ASSOCIATIONS

Any relationship between permanent party personnel and IET soldiers, not required by the training mission, is prohibited. The prohibition against any relationship between permanent party personnel and IET soldiers applies to permanent party personnel without regard to the installation of assignment of the permanent party member or the trainee.

There are two major categories of illegal associations:

1. Relationships between permanent party members and IET soldiers.
2. Relationships between IET soldiers.

Personal Relationships Between IET Soldiers and Permanent Party. Any relationship between permanent party personnel and IET soldiers not required by the

training mission is prohibited. This includes, but is not limited to, the following:

- Drinking, dancing, or gambling
- Writing and/or receiving personal letters
- Privately owned vehicles
- Sexual conversations
- Sexual contact (kissing, hugging, caressing, fondling, handholding)
- Sexual intercourse

Any relationship between permanent party personnel assigned or attached to the U.S. Army Recruiting Command and potential prospects, applicants, members of the Delayed Entry Program or Delayed Training Program, not required by recruiting mission, is prohibited.

Romantic Relationships Between IET Soldiers. Illegal associations between IET soldiers involve any actual or attempted consensual contact or socializing between or among soldiers who are in BCT or AIT, which involves any actual or attempted:

- Consensual contact or socializing between or among soldiers who are in BCT or AIT, which involves handholding, embracing, caressing, kissing, touching, massaging or fondling of a sexual nature, engaging in sexual intercourse or sodomy; or

- Use by a soldier in BCT or AIT of sexually explicit, suggestive, or obscene language or gestures directed towards, or with respect to another soldier in BCT or AIT; or
- Gender-based or race-based harassment or disparaging language or actions by a soldier or a group of soldiers in BCT or AIT directed towards another soldier or group of soldiers in BCT or AIT; or
- Entry into the living quarters, latrines, or other areas designated for the exclusive use of soldiers of the opposite sex, unless required by training mission/official duties or for health or safety emergencies.

Language, gestures, physical contacts, or socializing of a non-sexual, non-harassing nature, which arise out of the esprit and enthusiasm generated by the basic training mission and the professional development associated with BCT and AIT, are **not** illegal associations. There is no prohibition against IET soldiers of the same or opposite sex talking to one another or developing friendships.

Sexual Harassment Policy

The policy of the United States Army is that sexual harassment is inappropriate and unacceptable conduct. Sexual harassment destroys teamwork and is detrimental to combat readiness. The Army is an organization of people, and its success is based on their ability to perform

in an environment of mutual respect, dignity, and fair treatment.

Categories of sexual harassment include

- Verbal (Example: Telling sexual jokes)
- Nonverbal (Example: Blowing kisses)
- Physical Contact (Example: Touching or blocking a doorway)

Individuals who believe they are being sexually harassed are responsible for helping to resolve the issue. One way of accomplishing this is by confronting the harasser and telling him/her that the behavior is not appreciated, not welcome and must stop. Another way is to file an informal or formal complaint. Intimidation, harassment, or retaliation against those filing a complaint is not permitted.

Sexual harassment is a form of gender discrimination that involves **unwelcome** sexual advances, requests for sexual favors, and other verbal or physical conduct of a sexual nature when

- Submission to or rejection of such conduct is made a term or condition of a person's job, pay, or career, or
- Submission to or rejection of such conduct is used as a basis for career or employment decisions affecting that person; or

- Such conduct creates an intimidating, hostile or offensive working environment or unreasonably interferes with an individual's work performance.

Any person in a supervisory or command position who uses or condones any form of sexual behavior to control, influence, or affect the career, pay, or job of a military member or civilian employee is engaging in sexual harassment.

Any soldier or civilian employee who makes deliberate or repeated unwelcome verbal comments, gestures, or physical contact of a sexual nature is engaging in sexual harassment.

If you are uncomfortable because of certain sexual remarks or behaviors, you should be assertive. In responding to behavior that is or may become sexual harassment, you should tell the person how you feel. Describe what you do not like. Stay focused on the behavior and its impact. Clearly state what you want in the future, for example "*I do not want to hear that again*" or "*Do not touch me again.*"

If harassment continues after you have told the other person you do not like it, you should go to your immediate superior unless that is the person doing the harassing. In that case, go to his superior. If appropriate action is not taken, you may want to go up the chain of command or to the post Equal Opportunity adviser (EOA).

Sexual harassment is only one form of discrimination. Gender discrimination and discrimination based on race, religion, color, or national origin are also against the law.

Sexual Harassment Checklist:

1. Is the behavior sexual in nature?
2. Is the behavior unwelcome?
3. Does the behavior create a hostile or offensive work environment?
4. Have sexual favors been demanded, requested, or suggested (especially as a condition of employment or career and job success)?

Suggested Individual Actions to Deal with Sexual Harassment:

1. Confront the harasser.
2. File a complaint.
3. Use an intermediary spokesperson.
4. Write a letter to the harasser about the behavior and the expected resolution.
5. Report the harassment to the chain of command.

Appropriate Behavior

The phrase “appropriate behavior” describes how you, as a good soldier, are expected to behave. You are a soldier 24 hours a day and should always behave honorably. How you act reflects upon yourself, your unit, and those fighting men and women who have given their lives fighting for America.

Examples of inappropriate behavior include alcohol and drug abuse and intolerance of others. As a soldier, you can help prevent inappropriate behavior by promoting

- Behavior that is based on the Army Values – LDRSHIP (See Chapter 2)
- Tolerance of those different from us
- Ethical decision-making
- Adherence to the code of conduct

You can also help prevent inappropriate behavior by demonstrating RESPECT for others, their property, and respect for yourself.

Alcohol and Drug Abuse

Abuse of alcohol and drugs is incompatible with military service because it significantly impacts performance of the mission. Soldiers identified as abusers of alcohol or other drugs may enter into a rehabilitation program.

Success in the military is dependent upon your being an exemplary soldier. As a soldier, an individual must make

responsible decisions with regard to alcohol and the use of drugs. It is encouraged that soldiers refuse substances and set the example for other soldiers.

If you choose to abuse, you are subject to administrative and judicial actions. However, you can ask for help through your chain of command to include the chaplain.

Consideration of Others

Diversity is a positive aspect of military service. Consideration of others is defined as “those actions that indicate a sensitivity to and regard for the feelings and needs of others and an awareness of the impact of one’s own behavior on them; being supportive of and fair with others.”

The objective of the consideration of others program is to foster and strengthen the command climate by reinforcing the importance of trust, teamwork, dignity, and respect for others.

Homosexual Conduct Policy “Don’t Ask, Don’t Tell, and Don’t Harass.”

Sexual orientation is a private, personal matter.

Sexual *orientation* alone is not a bar to enlistment or continued service in the military.

Homosexual *conduct*, on the other hand, is incompatible with military service. The Department of

Defense has defined three types of homosexual conduct: statement, act, and marriage.

- **Statement:** Can be conveyed through language or behavior; indicates a propensity (i.e. likelihood) or intent to engage in homosexual acts. The soldier can present evidence that he/she does not engage in homosexual acts and does not have a propensity or intent to do so.
- **Act:** Any bodily contact, actively undertaken or passively permitted, between persons of the same sex for the purpose of satisfying sexual desires; and any bodily contact which a reasonable person would understand to demonstrate a propensity or intent to engage in an act described above.
- **Marriage:** Marrying or attempting to marry a person of the same sex.

The basic policy is - **“Don’t ask, don’t tell.”** This policy also means, **“Don’t Harass”**.

- **“Don’t Ask”** – The Army and individual soldiers have a responsibility not to ask about homosexual orientation.
- **“Don’t Tell”** – Soldiers should not disclose their sexual orientation. If soldiers do disclose their orientation, it may be used to separate them from the Army.

- **“Don’t Harass”** – Soldiers will not harass other soldiers based upon sexual orientation or conduct.

Homosexual *conduct* is incompatible with military service. Homosexual conduct includes *statements, acts, and same-sex marriages*. It does not include rumors, opinions, or *associational behavior*, such as associating with known homosexuals, frequenting homosexual or “alternative lifestyle” bars, reading homosexual publications, or participating in homosexual rallies in civilian clothes-

Service members are not allowed to ask or question other service members about their sexual orientation. If so, the person asking the question could be subject to punishment under the UCMJ (for example – Violation of Article 134, Conduct prejudicial to good order and discipline).

Remember the rule—sexual orientation **alone** is not a bar to entry or continued military service. However, if you reveal homosexual conduct, you open yourself up to questioning by the commander and adverse action, such as administrative separation, etc.

Don’t harass. Harassment of a soldier based upon sexual orientation or conduct is inappropriate. Harassment includes oral comments (on or off duty), derogatory references or language, jokes about homosexuals, jody calls about homosexuals, anonymous calls or e-mails, etc.

Harassment should be reported to the chain of command or other channels. Commanders will investigate and take appropriate action to protect the safety of the soldier, on and off duty. Each case will be treated individually depending on the facts. If a soldier has a concern or if they are uncomfortable discussing issues regarding homosexual conduct with the chain of command, they can discuss those matters in confidence with either a legal assistance attorney or chaplain.

Soldiers who report being harassed are not to be considered as verifying that the accusations are accurate. When a soldier reports harassment to commanders, it is not an admission of homosexuality and commanders should not regard it as if it were. Threats or harassment based on a soldier's perceived or alleged homosexuality does not, by itself, constitute credible information justifying an inquiry about homosexual conduct of the harassed soldier.

Homosexual conduct remains incompatible with military service. All soldiers, including those suspected of being homosexuals or pending separation for homosexuality, deserve to be treated with dignity and respect. Every soldier has the right to expect treatment consistent with our core Army values, a safe and secure living and working environment, and the support of their chain of command.

Dignity and Respect

Respect is one of the seven bedrock Army values. All **soldiers will be treated with dignity and respect** at all times. As a soldier, you will also be afforded a **safe and secure environment in which to live and work**.

Remember the Golden Rule - treat others as you wish to be treated, or how you would want your son or daughter to be treated.

If you are the victim of harassment or threats, **try to resolve it yourself**. If the treatment continues, **report it** to your chain of command. Commanders at every level will **take appropriate action** to prevent harassment or threats and provide safe and secure living and working environments.

Treating individuals with dignity and respect promotes compliance with Army policies concerning sexual harassment, racial and gender equality, homosexuality, consideration of others, (deleted), and core Army values. Our Army enjoys a worldwide centuries-earned reputation for fighting ferociously and treating people with dignity and respect. We must continue that tradition.

Rape Prevention

A sexual assault is defined, as any behavior of a sexual nature performed against another person against his or her will. It can occur in any type of relationship, including marriage. Sexual assault is a crime and is punishable

under the UCMJ and local civilian laws. Unless otherwise stated, each of these crimes carries a maximum penalty, in addition to confinement, a dishonorable discharge, and forfeiture of all pay and allowances. As a soldier, it is your duty to understand and abide by the Army's sexual assault and rape prevention policies, thereby honorably living up to the Army's values.

The Army's policy states that sexual assault, which includes forcible rape, sodomy, and indecent assault, is a criminal offense incompatible with the Army's high standards of professionalism and discipline. Commanders and supervisors of perpetrators will take appropriate disciplinary action and/or administrative action.

Rape is defined as sexual intercourse by force and without consent. Male and female soldiers can commit rape. The types of rape are physical and constructive force, date/acquaintance rape, and marital rape.

Suggested Actions to Prevent Becoming A Victim:

- Walk only in lighted areas after dark
- Buy time with the rapist by talking
- Attract help/attention
- Report misconduct
- Do not be intimidated

Instances of rape committed by a soldier impacts the Army's readiness and mission accomplishment.

If You Are A Victim:

- Go to a safe place where a phone is available
- Call the local or military police
- Do not shower, douche, change clothes, or straighten up the site where you were victimized
- Go directly to a hospital or clinic and have the police notified for you
- Call someone from your chain of command, a friend, a rape hotline, or social work services

If You Are Helping A Victim

When assisting a victim, you should

- Listen to what the victim has to say and sympathize
- Do not ask what the victim did to cause this to happen
- Support the victim in the decision and effort to report the crime
- Encourage them to talk to a professional counselor

Suicide Prevention

Suicide claims the lives of nearly 10,000 young adults annually. It is the second leading cause of death for people aged 18 – 24. Many suicides, if not most, are

preventable. As soldiers, it is your responsibility to report any action that would affect the readiness of your unit. It is also your responsibility to be loyal to your fellow soldiers by ensuring that they are never left in a situation that would cause them to be harmed. It is your respect for your fellow soldiers that makes you take the necessary steps to protect them from harm.

Threats are warning signs made by someone which could indicate that the person may be considering a suicidal act. Threats are sometimes very hard to recognize because they may be very subtle in nature. Never take a suicidal threat lightly.

Signs of Suicide

A suicidal individual may:

- appear depressed: sad, tearful, poor sleep, poor appetite, hopeless
- threaten suicide
- talk about wanting to die
- show changes in behavior, appearance, mood
- abuse drugs, alcohol
- experience significant loss
- deliberately injure self
- give away possessions
- have experienced a recent breakup in a relationship

What to Do

Provide **AID**:

- A – Ask. Don't be afraid to ask “Are you thinking about hurting yourself?”
- I – Intervene immediately
- D – Don't keep it a secret

*Follow the acronym **LIFE** (ALL FOUR steps in the acronym LIFE are EQUALLY important. Do not just follow the steps below sequentially.)*

- L – Locate help: CQ, Staff duty officer, chaplain, doctor, nurse, friend, family, crisis line, Hospital, Emergency Room.
- I – Inform: Drill Sergeant, chain of command, Chaplain or Chaplain Assistant, Medical Personnel.
- F – Find: Someone to stay with the person – *Don't leave the person alone.*
- E – Expedite: Get help immediately. A suicidal person needs immediate attention by helpers.

Depression: Depression is serious. Nearly 80% of depressed people attempt suicide. Sadness and “blue” feelings are shared by everyone, but depression clings to the mind, creating a sense of

ongoing sadness and hopelessness, even when the soldier experiences pleasant times.

Consider some indicators of depression:

- Poor appetite or significant weight loss, or increased appetite or significant weight gain
- Change in sleep habits, either excessive sleep or the inability to sleep
- A slowing of bodily movements
- Easily agitated
- Loss of interest or pleasure in usual activities
- Loss of energy, never-ending fatigue, physical and mental
- Diminished ability to think or concentrate
- Feelings of worthlessness, self-blame, or excessive guilt
- Withdrawal from friends, co-workers, spouse or children
- Drastic mood swings

Suicidal crises are almost always temporary. Although it might seem as if your unhappiness will never end, it is important to realize that crises end. Solutions are found, feelings change, unexpected positive events occur. Suicide is sometimes referred to as “a permanent solution to a temporary problem.” Don’t let suicide rob you of better times that would have come your way if only you had allowed more time to pass.

Do not keep suicidal thoughts to yourself! Help is available for you, whether through a soldier buddy, chaplain, or mental health professionals. Find someone you trust and let them know how bad things are for you. This can be your first step on the road to healing.

Depression is treatable. Death is final.

Ethical Decision-Making

The decisions that you make can have a far-reaching effect upon yourself, your unit, and the Army. It is up to you to make the ethical decision. An ethical decision is one that complies with the spirit and letter of the ethics regulations and the Seven Army Values.

The Ethical Decision-Making Process

1. What problem am I facing?
2. What are my choices?
3. Which choice is most consistent with Army values and regulations?
4. Make your decision and execute your plan.

AWARDS AND DECORATIONS OF THE UNITED STATES ARMY

Army awards fall into three categories:

- Personal and unit decorations
- Commemorative, campaign, and service medals
- Marksmanship badges and trophies

1. Personal and Unit Decorations -- Personal awards are conferred upon the individual for his or her act of heroism, specific act of gallantry, or for meritorious service during military or non-military feats. Some of these decorations, arranged in order of the degree of valor or achievement, are described as follows:

- a. The Medal of Honor is the highest and most rarely awarded decoration conferred by the United States. The medal is awarded for conspicuous gallantry and intrepidity at the risk of his or her life above and beyond the call of duty while engaged in an action against an enemy of the United States.
 - 1) While engaged in actions against “hostile” forces;
 - 2) While engaged in military operations involving conflict with opposing foreign force; or
 - 3) While serving with friendly foreign forces engaged in an armed conflict against an opposing armed force in which the U.S. is not a belligerent party.
- b. The Distinguished Service Cross is awarded to a person who, while serving in any capacity with the Army, distinguishes

himself or herself by extraordinary heroism not justifying the award of a Medal of Honor

- 1) While engaged in an action against an enemy of the United States;
- 2) While engaging in military operations involving conflict with an opposing/foreign force; or
- 3) While serving with friendly foreign forces engaged in an armed conflict against an opposing Armed Force in which the United States is not a belligerent party.

The act or acts of heroism must have been so notable and have involved risk of life so extraordinary as to set the individual apart from his or her comrades.

- c. The Purple Heart is awarded to persons serving in any capacity as a member of the U.S. Armed Forces who is killed or wounded (requiring treatment by a medical officer) in any action against enemies of the U.S., as a result of any act of any such enemy or opposing armed force, or as the result of maltreatment inflicted by captors while being held as a prisoner of war.

- d. Collective (unit) citations are made to an operating unit for outstanding performance, inside or outside of the U.S. It is worn by only those persons who were members of that unit during the action or period of time specified by the award.

2. Commemorative, campaign, and service medals are issued to soldiers who take part in particular campaigns or periods of service for which a medal is authorized. The Army Good Conduct Medal recognizes enlisted women and men who have served with exemplary behavior, efficiency, and fidelity in active Federal military service. Qualifying periods of service include:

- 1. Each 3 years completed on or after 27 August 1940; 2. For first award only, upon termination of service on or after 27 June 1950, of less than 3 years but more than 1 year; 3. For first award only, upon termination of service on or after 27 June 1950, of less than 1 year when final separation was by reason of physical disability incurred in line of duty; and 4. For first award only, for those individuals who died before completing 1 year of active Federal military service if the death occurred in the line of duty. The following disqualification rules must be observed.

- a. Conviction by courts-martial terminates a period of qualifying service; a new period begins the following day after completion of the sentence imposed by court-martial.

- b. Individuals whose retention is not warranted under standards prescribed in AR 604-10, paragraph 2-1 or for whom a bar to reenlistment

has been approved under the provisions of AR 601-280, chapter 6 are not eligible for award.

- c. Disqualification as determined by the unit commander. The commander will prepare a statement of rationale for his/her decision. The statement will include the period of disqualification and will be referred to the individual.
- d. Disqualification for an award of the Army Good Conduct Medal can occur at any time during a qualifying period (for example, when the manner of performance or efficiency declines.)

3. Marksmanship badges and trophies -- Badges awarded to individuals who qualify because they have demonstrated some special proficiency or skill. Marksmanship badges are worn to indicate the individual's prowess with specific weapons, pistols, and/or rifles, during specified competitions, matches, or practice exercises.

The trophies are awarded at various levels to include: United States and international distinguished shooter competitions, US Army rifle and pistol championships, national trophies for rifle and pistol championships, interservice rifle and pistol matches, combat exercises, and division contests.

TERRORISM

In 1992, an American soldier was killed in an ambush in Panama. In 1991, another soldier was killed in Panama in a drive-by shooting. Also in 1991, a bomb in the entryway of his Korean apartment house killed an Air Force sergeant. Personal animosity did not cause these incidents. These soldiers were killed simply because they were American military personnel. As symbols of United States power, soldiers are always at risk from criminals and terrorists. While the level and type of threat vary from place to place and time to time, you can do several things to make yourself less likely to be the target of a criminal or terrorist. By practicing these principles at all times, you will be better prepared for that time when you are living and working in an elevated threat environment.

- Know the threat in your area. Be especially cautious in high-crime areas or areas with a history of terrorist activity.
- Routinely practice crime-prevention measures.
- Be inconspicuous. DO NOT call attention to yourself by dress or action, such as by talking loudly or flashing large sums of money.
- Involve your family in security. A good personal security program covers security at work, at home, and while traveling.
- Ensure family members know where other members are at all times.

- Ensure children DO NOT give any personal information, such as phone numbers, where parents work, etc., to strangers.
- Answer the phone "*Hello*"; never give your name until the caller identifies himself or herself.
- Ensure family members know emergency phone numbers (police, fire, medical).
- When traveling, DO NOT discuss your work with strangers (no one on the bus, airplane, or train needs to know that you are a soldier).
- DO NOT use luggage or wear clothing or accessories that identify you as a soldier.
- DO NOT work or drive in isolated or high-crime areas.
- Avoid public demonstrations.
- Know where safe areas are (police stations, military installations).
- Report all suspicious personnel or activities, to include surveillance, to proper authorities (chain of command, security officer, police). DO NOT confront suspicious personnel.

Above all, stay alert. If something seems "*wrong*," it might well be. Most attacks against US military personnel occurred when off-duty or traveling personnel who were not following sound security practices. Remember, there is no honor in becoming a victim of a criminal or terrorist attack, so practice personal protection to keep yourself and your family from becoming a victim.

CHAPTER 4

BASIC SOLDIER SKILLS

SERVE AS A MEMBER OF A TEAM

The Army defines **team** as a "group of individuals banded together along organizational lines for the purpose of accomplishing a certain goal."

Cohesion is the "glue" that brings people together to make a team. It helps soldiers to develop and sustain their commitment and resolve to accomplish the unit's mission.

The Army's description of cohesion includes these elements:

- **Bonding:** "The development of strong interpersonal relationships among soldiers, and between them and their leaders."
- **Commitment:** "Dedication not only to the unit and what it represents, but to the values and goals of the nation as well."
- **Resolve:** "The shared determination of soldiers and their leaders to work interdependently to accomplish the mission, and to sustain this capability over a long period of time."

Cohesion is dependent on several factors:

- Common goal
- People working together.

- Effective communication
- Mutual assistance

The Buddy System

The Army's Buddy System provides every soldier an assigned buddy.

Requirements to be a buddy:

- In IET, the norm is only same-gender soldiers will be buddies.
- If there are non-English speaking soldiers in a platoon, they will be paired with English-speaking buddies who can assist in interpreting instructions.
- You will be paired based on your strengths that can complement another's weaknesses.

Responsibilities of a buddy:

- Never go anywhere without a buddy.
- Inform your buddy where you will be at all times.
- Pass on information that might affect your buddy.
- Discuss each day's training and the next day's activities.
- Lean on each other for problem solving. Help each other.

- Encourage your buddy to complete successfully all training requirements.
- Make sure your buddy adheres to appearance and conduct standards.
- Inform the drill sergeant of any problems or status changes in your buddy.
- Assist your buddy in living the Army core values.

The soldier's responsibilities to the unit team:

- Commit to the squad, platoon, company, and unit above self.
- Cooperate with peers to accomplish goals.
- Adopt standards and values of the unit.

DRILL AND CEREMONIES

Drill Procedures

Many drill procedures used by the United States Army today were developed during the Revolutionary War. The purpose of the drill then was to instill discipline in American soldiers. As these soldiers mastered the art of the drill, they began to work as a team and to develop a sense of pride in themselves and in their unit. In today's Army, the same objectives—teamwork, confidence, pride, alertness, attention to detail, esprit de corps, and discipline—are accomplished by drill.

A drill consists of a series of movements by which a unit or individuals are moved in an orderly, uniform manner from one formation to another or from one place to another. Units vary in size, but in basic combat training (BCT), you will ordinarily be part of a squad, section, platoon, or company. Figure 4-1, illustrates some drill formations.

Figure 4-1. Drill formations (without weapons).

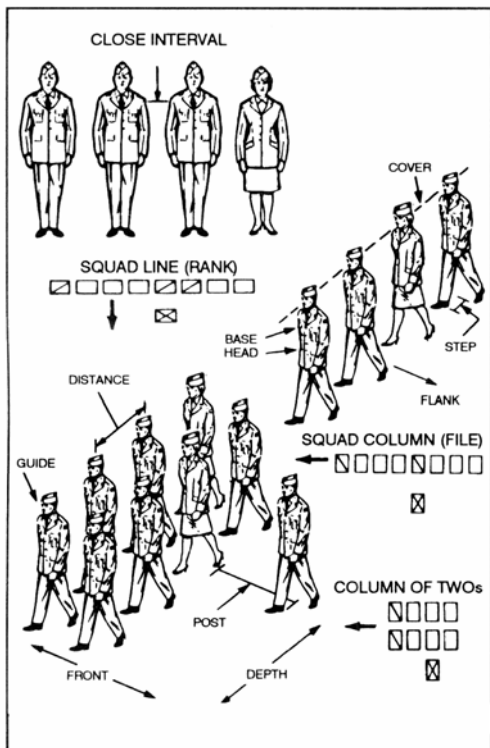

You will need to know the following drill terms:

Element. This is an individual, squad, section, platoon, company, or larger unit formed as part of the next higher unit.

Formation. This is an arrangement of the unit's elements in a prescribed manner such as a line formation, in which the elements are side-by-side, and column formation, in which the elements are one behind the other. In a platoon column, the members of each squad are one behind the other with the squads abreast.

Front. This is a space from one side to the other side of a formation, and includes the right and left elements.

Depth. This is a space from the front to the rear of a formation, including the front and rear elements.

Distance. This is the space between elements that are one behind the other. The distance between individuals is an arm's length plus 6 inches, or approximately 36 inches, measured from the chest of one soldier to the back of the soldier immediately to his front.

Interval. This is the space between side-by-side elements.

Rank. This is a line that is only one element in depth.

File. This is a column that has a front of one element.

Guide. This is the person responsible for maintaining the prescribed direction and rate of march.

Post. This is the correct place for an officer or noncommissioned officer to stand in a prescribed formation.

Head. This is a column's leading element.

Base. This is the element around which a movement is planned or regulated.

Cadence. This is a uniform rhythm or number of steps or counts per minute.

Quick Time. This is a cadence of 120 counts (steps per minute).

Double Time. This is a cadence of 180 counts (steps per minute).

Drill commands are oral orders given by your commander or leader, usually in two parts. The preparatory command states the movement to be carried out and gets you ready to execute the order. The command of execution tells when the movement is to be carried out. In the command "*Forward, march,*" the preparatory command is "*Forward*" and the command of execution is "*March.*"

In some commands, the preparatory command and the command of execution are combined, for example, "*Fall in,*" "*at ease,*" and "*Rest.*" These commands are given without inflection and at a uniformly high pitch and loudness comparable to that of a normal command of execution.

Stationary Positions

Attention. Figure 4-2 illustrates the position of attention. You should assume this position on the command "*Fall in*" or "*Squad/platoon, attention.*"

Your weight should be distributed equally on the heels and balls of your feet. When you come to attention, bring your heels together smartly with your toes forming a 45-degree angle, as shown in Figure 4-2. Keep your legs straight without locking your knees. Hold your body erect with your hips level, your chest lifted, and your shoulders square and even. Your arms should hang straight, but not stiff, with the backs of your hands outward. Curl your fingers so that the tips of your thumbs are alongside and touching the first joint of the forefingers. Your thumbs should be straight and along the seams of your trousers or skirt. The first joint of your forefingers should touch the trousers or skirt. Keep your head erect, and look straight to the front.

Practice assuming the position of attention so you can do it properly. All movements except rest movements start from this position.

Parade Rest. The command to assume this position is "*Parade, rest.*" Parade rest is commanded only from the position of attention (Figure 4-2). On the command of execution, "*Rest,*" move your left foot 10 inches to the left of your right foot. Rest your weight equally on the heels and balls of both feet, keeping your legs straight without locking your knees. At the same time you move your feet, place your hands at the small of the back, centered on your belt. Keep the fingers of both hands extended and joined, interlocking your thumbs, as shown in Figure 4-2, so that the palm of your right hand is outward. Hold your head

erect and look straight to the front. Remain silent and do not move. If you are at the position of at ease, stand at ease, or rest, you should assume the parade rest position on hearing the preparatory command for attention.

Figure 4-2. Stationary positions.

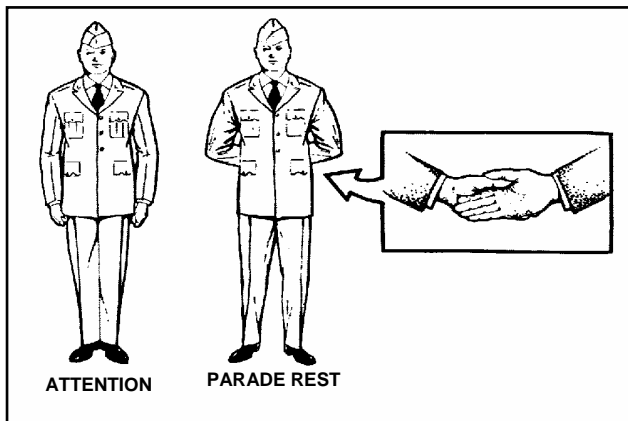

Stand at Ease. The stand-at-ease position is like parade rest, but with your head and eyes turned directly toward the commander. The command for this position is "*Stand at ease.*" "*At ease*" or "*Rest*" may also be commanded from this position.

At Ease. The command for this movement is "*At ease.*" On the command "*At ease,*" the soldier may move; however, he must remain standing and silent with his right foot in place.

Rest. The command for this movement is "Rest." On the command REST, the soldier may move, talk, smoke, or drink from a canteen unless otherwise directed. He must remain standing with his right foot in place. "At ease" may be executed from this position.

Facing Movements. Facing to the flank is a two-count movement for turning to one side or the other. The command is "Left, face" or "Right, face." Figure 4-3, page 4-5 illustrates "left face." On the command of execution, "Face," slightly raise yourself 90 degrees to the left on your left heel. A slight pressure on the ball of your right foot will help you do this correctly. Keep your right leg straight, but not stiff. On the second count, place your right foot beside your left foot, and resume the position of attention. Hold your arms as you would while at attention as you execute this movement. Right face will be executed in the very same way as left face, simply substituting right for left and left for right.

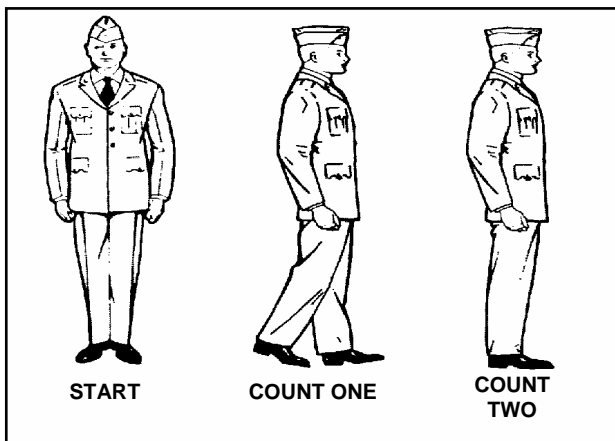

Figure 4-3. Face to the flank.

Face to the Rear. Facing to the rear is also a two-count movement and is illustrated in Figure 4-4. The command is "*About, face.*" On the command of execution, "*Face,*" touch the toe of your right foot to the ground about half the length of your foot to the rear and slightly left of the left heel. Rest your weight on the heel of your left foot, and allow your right knee to bend naturally. On the second count, turn 180 degrees to the right on the left heel and on the ball of the right foot, resuming the position of attention. Hold your arms at attention when executing this movement.

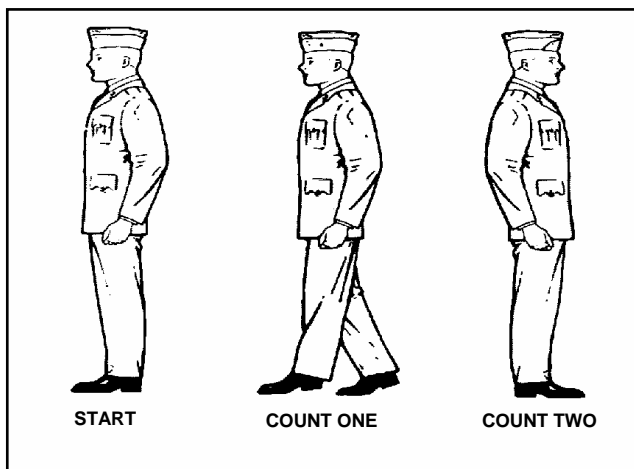
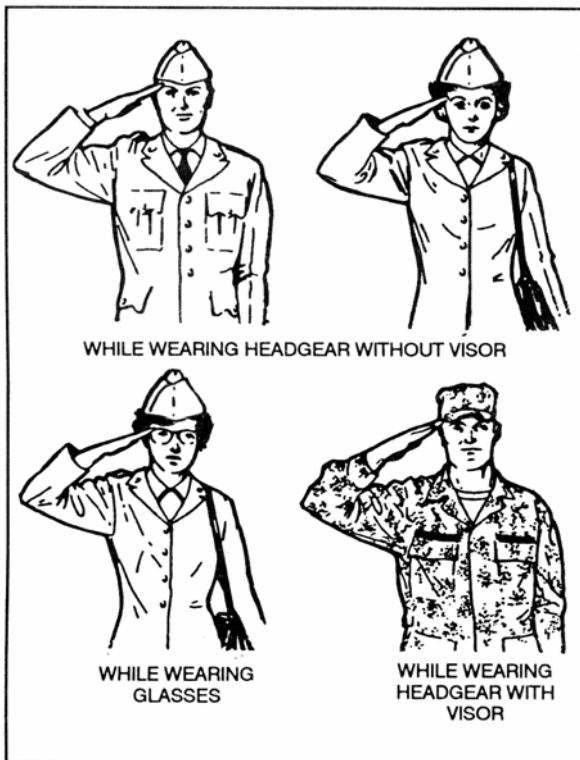

Figure 4-4. Face to the rear.

Hand Salute. The hand salute is a one-count movement. The command is "*Present, arms.*" When wearing headgear with a visor (with or without glasses), on the command of execution, "*Arms,*" raise the right hand sharply, fingers and thumb extended and joined, palm facing down, and place the tip of the right forefinger on the rim of the visor

slightly to the right of the right eye. The outer edge of the hand is slightly canted downward so that neither the back of the hand nor the palm is clearly visible from the front. The hand and wrist are straight, the elbow inclined slightly forward, and the upper arm horizontal as shown in Figure 4-5.

Figure 4-5. Hand salutes.



When wearing headgear without a visor or when uncovered, and when not wearing glasses, execute the hand salute in the same manner as previously described, except touch the tip of the right forefinger to the forehead near the right eyebrow, slightly to the right of the right eye.

"Order, arms" is a one-count movement from the hand salute. On the command of execution, *Arms*, return the hand sharply to the side, resuming the position of attention.

When reporting or rendering courtesy to an individual, turn the head and eyes toward the person addressed and simultaneously salute. In this situation, the actions are executed without command. The salute is initiated by the subordinate at the appropriate time and terminated upon acknowledgement.

The hand salute may be executed while marching. When double-timing, a soldier must come to quick time before saluting. However, when a formation is marching at double time, only the individual in charge assumes quick time and salutes.

Steps and Marching

All steps in marching are variations of 30-inch or 15-inch steps. You must learn these well before you can proceed to unit drill. All marching movements executed from the halt begin from the position of attention. All marching movements, except for route step, march, and at ease, march, can be executed from the halt. All steps except right step march begin with the left foot.

30-Inch Step. The command to march with a 30-inch step from the halt is "*Forward, march.*" When you hear the "*Forward,*" shift your weight to the right leg without noticeable movement. On the command of execution, "*March,*" step forward with your left foot and continue marching with 30-inch steps keeping your head and eyes forward. Your arms should swing in a natural motion, without bending at the elbows, about 9 inches straight forward and 6 inches to the rear of the seams of your trousers or skirt. Keep your fingers curled as in the position of attention.

Change Step. The command "*Change step, march*" is given as the right foot strikes the ground. When you hear "*March,*" take one more step with your left foot. Then, in one count, place your right toe near the heel of your left foot and step off again with your left foot. You should execute this movement without command if you find yourself out of step with other members in your formation.

Rest Movement (30-Inch Step). When you hear the command "*At ease, march,*" you do not have to march in cadence. You must remain silent and maintain the same interval and distance as before. The command "*Route step, march,*" means the same as "*At ease, march,*" except that you may talk.

15-Inch Step (Half Step). The command for marching with a 15-inch step is "*Half step, march.*" This command may be given from the halt, or it may be given to change a 30-inch step to a 15-inch step while marching. If the command is given from the halt, proceed as for marching with the 30-inch step, but take only 15-inch steps. If the command is given while you are marching with 30-inch

steps, you will hear the command *"Half Step March."* Take one more 30-inch step and then begin marching with 15-inch steps. Allow your arms to swing naturally.

Halt. To halt while marching, the command *"Squad/platoon, halt"* is given as either foot strikes the ground. The movement is executed in two counts. On hearing *"Halt,"* take one more step and then bring your trailing foot alongside your leading foot, resuming the position of attention.

Marching in Place. To march in place, the command is *"Mark time, march."* When you hear *"March,"* take one more step, bring the trailing foot alongside your leading foot, and begin marching in place. To do this, raise each foot alternately 2 inches off the ground. Your arms should continue to swing naturally.

15-Inch Step (Right/Left). To march with a 15-inch step right or left, you must begin from the halt. To march right, the command is *"Right step, march."* On hearing *"March,"* bend your right knee slightly, and raise your right leg only high enough to allow freedom of movement. Place your right foot 15 inches to the right of your left foot, then move the left foot (keeping your left knee straight) alongside the right foot temporarily assuming the position of attention. To march to the left, go through the same movements in response to the command *"Left step, march,"* except reverse the instructions. On hearing *"Halt,"* take one more step with your lead foot, place your trailing foot alongside your lead foot, and resume the position of attention.

15-Inch Step (Backward). The command to march with a 15-inch step backward is *"Backward, march."* When you hear *"March,"* take a 15-inch step backward with your left

foot and continue marching backward with 15-inch steps. Allow your arms to swing naturally.

30-Inch Step (Double Time). The command to march at 180 steps per minute is "*Double time, march,*" which can be given while at halt or while marching at quick time. When you are at halt and you hear "*Double time,*" shift your weight to your right leg without noticeable movement. When you hear "*March,*" raise your forearms to a horizontal position with your fingers and thumbs closed, knuckles out, and at the same time step off with your left foot. Continue to march with 30-inch steps at the cadence of double time. Let your arms swing naturally to the front and rear, while keeping your forearms horizontal.

When you are marching with a 30-inch step in the cadence of quick time and hear "*Double time, march,*" take one more step at quick time upon hearing "*March.*" Step off with your trailing foot, double-timing as previously described.

To resume quick time marching from double-time marching, respond to the command "*Quick time, march,*" take two more 30-inch steps at double time, lowering your hands to your sides, and resume marching with a 30-inch step at quick time.

Manual of Arms (M16A2 Rifle)

All soldiers must be able to execute the drill movements called the manual of arms with the M16A2 rifle, both at halt and while marching. Do not carry the magazine in the weapon when you are drilling. If you are performing duty that requires the use of the magazine, carry the weapon at sling arms. Figure 4-6 shows the parts of the rifle referred to in the manual of arms.

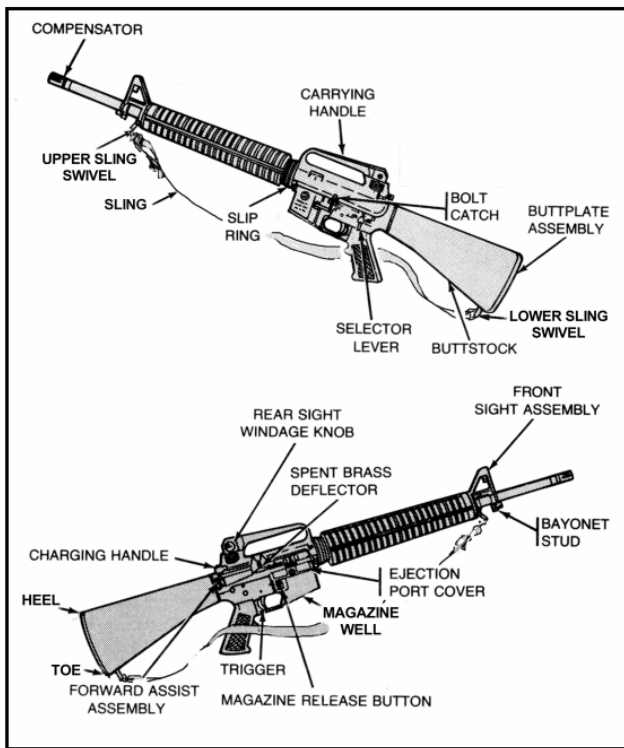

Figure4-6. Parts of a rifle.

Order Arms. Assume order arms on hearing the command "*Fall in*" or, if at parade rest, on hearing the command of execution, "*Attention.*" Order arms is the position of attention with the rifle (Figure 4-7). Center the butt of the weapon on your right foot, with sights to the rear. The toe

of the butt should touch your foot so the rear sight and pistol grip form a line straight to the front. Hold the weapon with your right hand in a U formed by extending your joined fingers and thumb. Hold the weapon above the sight, with the right thumb and forefinger pointed downward and on line with the flat surface of the hand guard. Keep your right hand and arm behind the rifle so that your thumb is along the seam of your trousers or skirt.

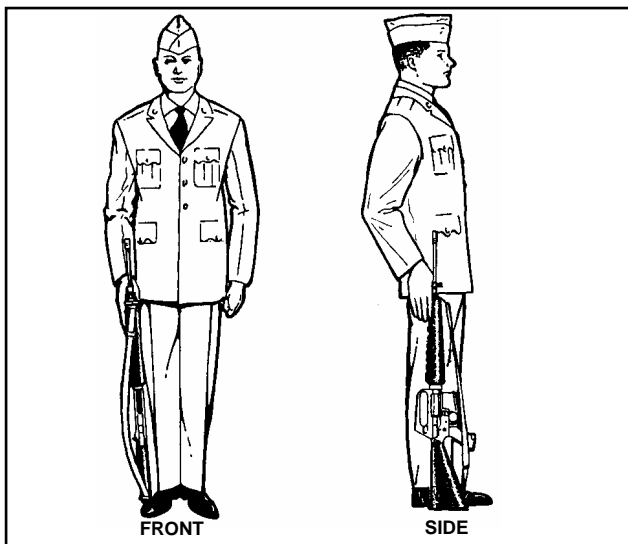

Figure 4-7. Order arms (attention position).

Rest Position (with M16A2 Rifle). Assume the rest position with the rifle the same as you would without it, plus the following steps:

- On the command "*Parade, rest,*" grasp the barrel with the right hand and thrust the muzzle forward, keeping the right arm straight (Figure 4-8).
- Execute stand at ease in the same manner as parade rest with the rifle, except turn your head and eyes toward the commander.
- On the command "*At ease*" or "*Rest,*" keep the butt of the rifle in place.

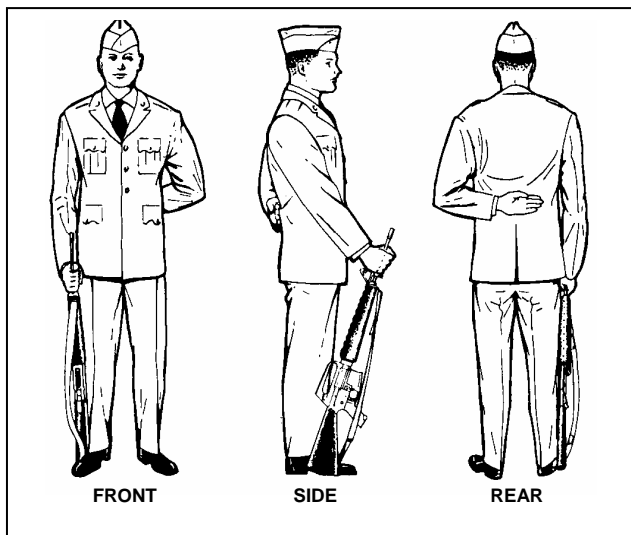

Figure 4-8. Parade rest (rest position).

Port Arms. Port arms from order arms is a two-count movement. The command is "*Port, arms.*" On the command of execution, "*Arms,*" grasp the rifle barrel with the right hand and raise the rifle diagonally across the

body, keeping the right elbow down (without strain). With the left hand, simultaneously grasp the hand guard just forward of the slip ring so that the rifle is about 4 inches from the belt. On the second count, regrasp the rifle at the small of the stock with the right hand. Hold the rifle diagonally across the body about 4 inches from the belt, with the right forearms horizontal and the elbows close to the sides (Figure 4-9).

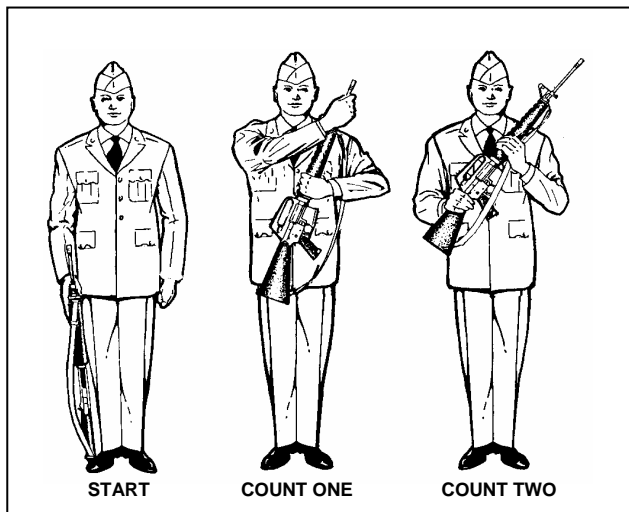

Figure 4-9. Port arms.

Present Arms. Present arms from order arms is a three-count movement. The command is "*Present, arms.*" On the command of execution, "*Arms,*" execute port arms in two counts. On the third count, twist the rifle with the right hand so that the magazine well is to the front, and

move the rifle to a vertical position with the carrying handle about 4 inches in front of and centered on the body. Lower the rifle until the left forearm is horizontal; keep the elbows in at the sides (Figure 4-10). To render reports or courtesy to an individual from order arms, execute present arms as discussed, but turn your head and eyes towards the individual addressed.

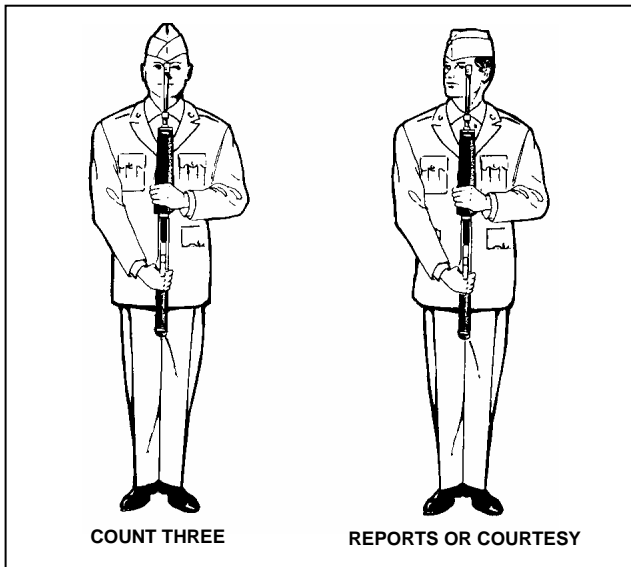

Figure 4-10. Present arms.

Inspection Arms. Inspection arms from order arms is a seven-count movement. The command is "Inspection, arms." On the command of execution, "Arms," execute port arms in two counts. On the third count, move the left hand from the handguard and grasp the pistol grip, thumb over the lower portion to the bolt catch. On the fourth count, release the grasp of the right hand unlock the charging handle with thumb, and sharply pull the charging handle to the rear with the thumb and forefinger (A, Figure 4-11). At the same time apply pressure on the lower portion of the bolt catch, locking the bolt to the rear.

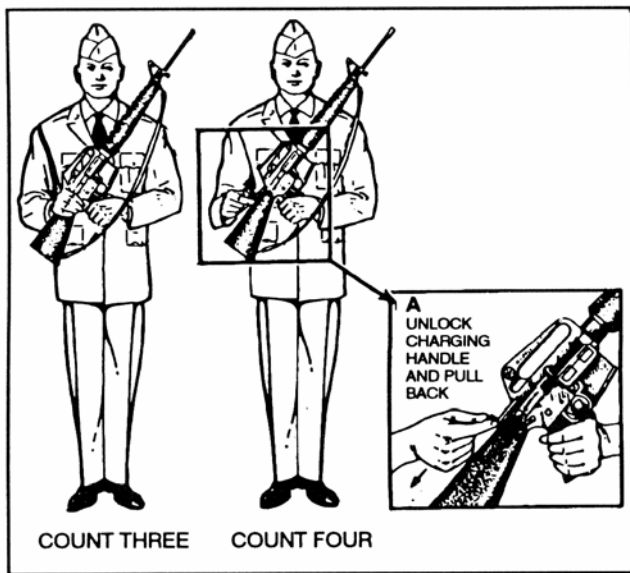

Figure 4-11. Inspection arms

On the fifth count, without changing the grasp of the right hand, sharply push the charging handle forward (B, Figure 4-11) until it is locked into position (C, Figure 4-11). Then regrasp the rifle with the right hand at the small of the stock. On the sixth, count remove the left hand, twist the rifle with the right hand so that the ejection port is skyward. Regrasp the handguard with the left hand just forward of the slip ring, and visually inspect the receiver through the ejection port. On the seventh count, with the right hand, twist the rifle so that the sights are up.

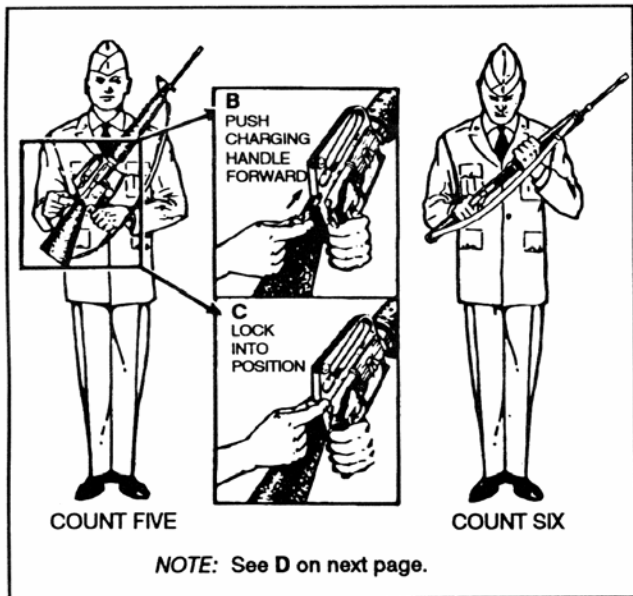

Figure 4-11. Inspection arms (continued).

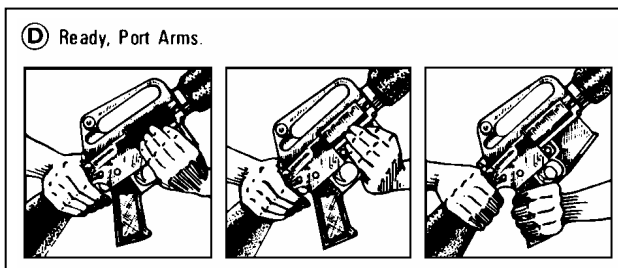

Figure 4-11. Inspection arms (continued).

"Ready, port, arms" is the only command given from inspection arms. The command "Ready," move the left hand and grasp the rifle with the thumb and fingers forming a U at the magazine well and trigger guard, and the thumb (without pressure) on the upper part of the bolt catch (D, Figure 4-11). On the command "Port," press the bolt catch and allow the bolt to go forward. With the fingertips, push upward and close the dust cover. Grasp the pistol grip with the left hand and place the left thumb on the trigger. On the command "Arms", pull the trigger and resume port arms.

Right Shoulder Arms. Right shoulder arms from order arms is a four-count movement. The command is "Right shoulder; arms." On the command of execution, "Arms," grasp the barrel of the weapon with the right hand and raise it diagonally across the body. With the left hand, grasp the handguard just in front of the slip ring. On the second count, release the barrel with the right hand and grasp the butt, positioning the rifle as shown in Figure 4-12. On the third count, twist the rifle and place it on the right shoulder. At the same time, move the left hand to the

small of the stock and guide the weapon to your shoulder. Your left hand should be placed as shown in Figure 4-12, with the first joint of your left forefinger touching the rear of the charging handle. On the fourth count, move your left hand back to your side at attention.

Order arms from right shoulder arms is a four-count movement. The command is *"Order, arms."* On hearing *"Arms,"* press down quickly on the butt and guide the rifle diagonally across the body. At the same time, turn the butt to keep the sight up. Grasp the rifle at the handguard, just in front of the slip ring, with the left hand, keeping your right hand on the butt of the rifle. On the second count, move your right hand up and across your body and grasp the barrel. The third and fourth counts are the same as from port arms to order arms.

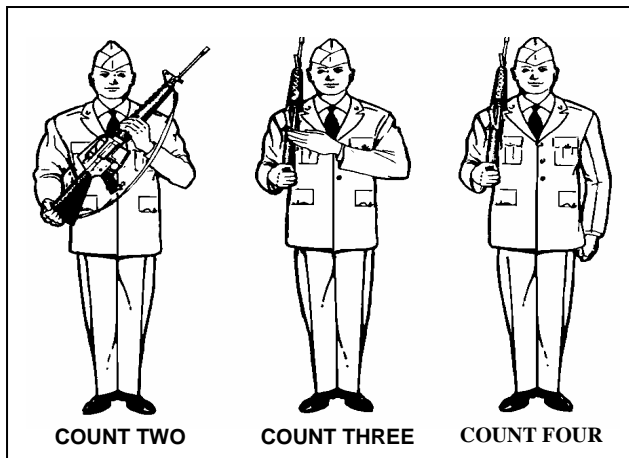

Figure 4-12. Right shoulder arms.

Left Shoulder Arms. Left shoulder arms from order arms is a four-count movement. The command is "*Left shoulder, arms.*" On the command of execution, "*Arms,*" execute port arms in two counts, then proceed as shown in Figure 4-13.

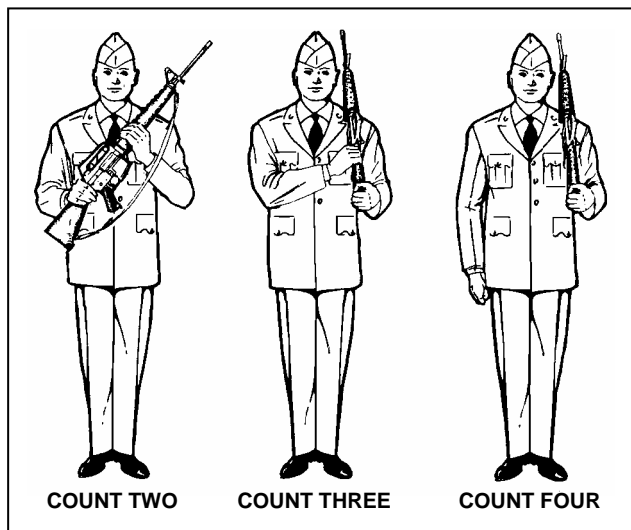

Figure 4-13. Left shoulder arms.

Order arms from left shoulder arms is a five-count movement. The command is "*Order, arms.*" On hearing "*Arms,*" move your right hand up and across the body and grasp the small of the stock, keeping the right elbow down. On the second count, move the rifle diagonally across your body with your right hand while regrasping the handguard just in front of the slip ring with your left hand. Counts three, four, and five are the same as the order arms from port arms.

Sling Arms (with M16A2 Rifle). From the order arms position (sling tight), the command is "*sling, arms.*" On the command of "*arms,*" raise the weapon vertically, and with the left hand place the butt on the right hip. Cradle the weapon with the right arm, loosen the keeper, and adjust the sling with both hands. Then sling the weapon on the right shoulder in the most convenient manner (Figure 4-14).

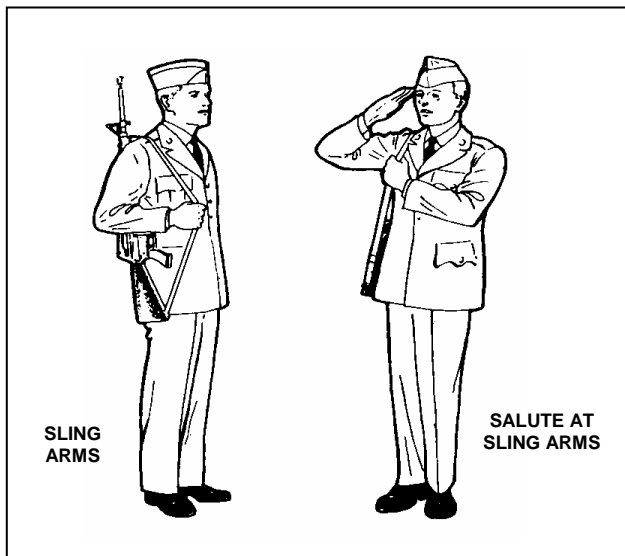

Figure 4-14. Positions at sling arms.

To return the weapon to order arms, the command is "*Unsling, arms.*" On hearing "*arms*", reach across your body with your left hand and grasp the sling at the shoulder. Unslung the weapon and return to the position of order arms.

Salute at Sling Arms. The command for saluting while at sling arms is "*Present, arms.*" When you hear "*Arms,*" reach across your body with your left hand and grasp the sling just above the right hand. Release your right hand and execute the salute as shown in Figure 4-14. If rendering reports or courtesies to an individual, execute the salute without an order.

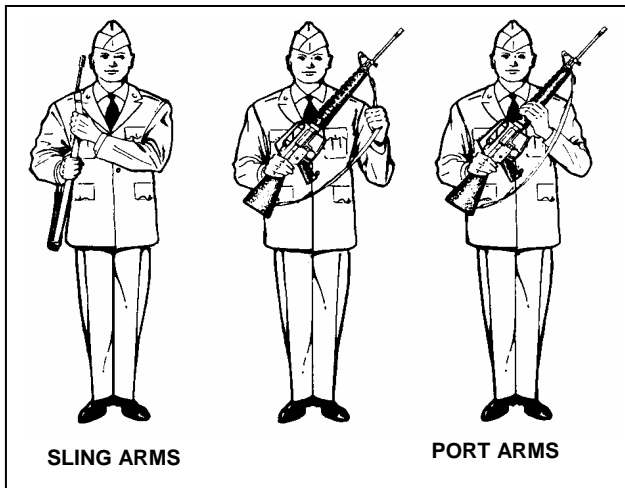

Figure 4-15. Port arms from sling arms.

Order Arms at Sling Arms. To terminate the hand salute, the command is "*Order, arms.*" On the command of execution, "*Arms,*" lower the right hand sharply to the side as in the position of attention and then regrasp the sling at the original position with the right hand. Release the left hand and return it sharply to your left side as in the position of attention.

Port Arms from Sling Arms. The command for this movement is "*Port, arms.*" On hearing "*Arms,*" reach across your body with your left hand and grasp the sling at the shoulder (Figure 4-15). Lift the weapon by the sling, swing it to the front of your body, and grasp the small of the stock with your right hand. Release the sling and regrasp the weapon just in front of the slip ring with the left hand.

To resume sling arms, grasp the sling near the upper sling swivel with your left hand upon hearing "*Arms*" in the command "*Sling, arms.*" Release your right hand and swing the weapon back onto your shoulder by inserting your right arm through the sling, immediately resuming the position of sling arms.

Inspection arms from sling arms. The command for this movement is "*Inspection, arms.*" On the command of execution, "*Arms,*" execute port arms as described above, then execute counts three through seven in the same manner as inspection arms from order arms (Figure 4-11).

Your drill sergeant will use the following evaluation guides to test your ability to execute drill movements:

Evaluation Guide

Execute Drill Movements with Arms (Stationary)

Performance Measures (Sequence is scored.)

1. **"Inspection arms"** (from sling arms). On the command, "*Inspection arms,*" the soldier—
 - a. Grasps the sling with the left hand at point near the shoulder.

b. Lifts the rifle from the shoulder, removing the right arm from between the rifle and the sling.

c. Grasps the small of the stock with the right hand and brings the weapon diagonally across the body, to port arms.

d. With the left hand, grasps the pistol grip, thumb over the lower portion of the bolt catch.

e. Releases the grasp of the right hand, unlocks the charging handle with the thumb, and sharply pulls the charging handle to the rear with the thumb and forefinger.

f. Presses the bolt catch, locking the bolt to the rear.

g. Pushes the charging handle until it locks in its foremost position, and grasp the small of the stock with the right hand.

h. Releases the left hand, rotating the weapon, and regrips the handguard, while visually inspecting the receiver through the ejection port.

i. Returns the weapon diagonally across and about 4 inches from the body (port arms).

j. Holds the head and eyes at position of attention.

k. Keeps the right forearm horizontal and elbows resting against the sides.

1. Remains at the position of attention throughout the movement, except for the movement required for performance measures 1a through 1k.

2. "Ready, port, arms."

a. On the preparatory command, "*Ready*," of "*Ready, port, arms*" (given only from inspection arms), the soldier moves the left hand and regrips the weapon with the thumb and fingers, forming a U at the magazine well and trigger guard, with the thumb on the upper part of the bolt catch.

b. On the preparatory command, "*Port*" of "*Port, arms*," the soldier—

(1) Presses the bolt catch, letting the bolt go forward.

(2) With the fingertips, pushes upward and closes the dust cover.

(3) Grasps the pistol grip with the left hand and places the left thumb on the trigger.

(4) On the command, "*Arms*," pulls the trigger and resumes port arms.

Note: Return to sling arms (ungraded).

3. "Present arms/order arms" (from sling arms).

a. On the command, "*Arms*" of "*Present, arms*," the soldier—

(1) Reaches across the body with the left hand and grasps the sling just above the right hand.

(2) Releases the sling and performs the hand salute with the right hand.

b. On the command, "*Order, arms,*" the soldier—

(1) Lowers the right hand to the side, then regrips the sling at the original position.

(2) Releases the sling with the left hand and returns it to the left side as at the position of attention.

4. "**Parade rest**" (from sling arms). On the command, "*Parade rest,*" the soldier—

a. Moves left foot 10 inches to the left of the right foot.

b. Rests body weight equally on the heels and balls of feet.

c. Places left hand behind the back at the middle of the belt. Keeps fingers and thumb extended and joined.

d. Grasps the sling with the right hand, keeping the right forearm horizontal and the weapon vertical.

e. Holds head and eyes at position of attention.

5. "**Group, attention**" (from sling arms). On the command, "*Group, attention,*" the soldier—

a. Brings heels together on the same line at a 45-degree angle.

b. Keeps legs straight without locking knees.

c. Holds body straight, hips level, chest lifted and arched, and shoulders even.

d. Lets left arm hang straight, back of hand outward, fingers curled, thumb touching first joint of forefinger, thumb straight and touching seam of trousers.

e. Grasps the sling with the right hand, keeping the right forearm horizontal and the weapon vertical.

f. Holds head erect, straight, and to the front, with eyes looking straight ahead.

g. Rests body weight equally on heels and balls of feet, and remain silent except when replying to a question or when otherwise directed.

6. "**Right, face**" (from sling arms). On the command, "*Right, face,*" the soldier—

a. Slightly raises left heel and right toe and turns 90 degrees to the right on right heel, assisted by a slight pressure on the ball of the left foot.

b. Holds left leg straight.

c. Places left foot beside right foot, as in the position of attention.

d. Holds arms as at attention when performing this movement.

7. **"Left, face."** On the command, "*Left, face,*" the soldier—

a. Slightly raises right heel and left toe and turns 90 degrees to the left on the left heel and ball of right foot, assisted by a slight pressure on the ball of the right foot.

b. Holds right leg straight.

c. Places right foot beside left foot, as in the position of attention.

d. Holds arms as at attention when performing this movement.

Evaluation Guide

Execute Drill Movements with Arms (Marching)

Performance Measures
(Sequence is scored.)

1. **"Forward, march."** On the command, "*Forward, march,*" the soldier—

a. Steps off with the left foot, taking a 30-inch step, and continues to march.

b. Swings the left arm naturally, without bending the elbow, about 9 inches to the front and 6 inches to the rear, keeping the fingers curled.

c. Holds sling with right hand, keeping the forearm horizontal and the weapon vertical.

d. Holds head and eyes to the front.

2. "**Left flank, march.**" On the command, "*Left flank, march,*" the soldier—

a. Takes one more step with the right foot.

b. Pivots on the ball of the right foot 90 degrees to the left, and at the same time steps off with the left foot in the direction of march; continues to march.

3. "**Right flank, march.**" On the command, "*Right flank, march,*" the soldier—

a. Takes one more step with the left foot.

b. Pivots on the ball of the left foot 90 degrees to the right, and at the same time steps off with the right foot in the direction of march; continues to march.

4. "**Half step, march.**" On the command, "*Half step, march,*" the soldier—

a. Takes one more 30-inch step, then begins marching with 15-inch steps.

b. Swings the left arm naturally, without bending the elbow, about 9 inches forward and 6 inches to the rear, keeping the fingers curled.

c. Holds sling with right hand, keeping the right forearm horizontal and the weapon vertical.

d. Holds head and eyes to the front.

5. "**Mark time, march.**" On the command, "*Mark time, march,*" the soldier—

a. Takes one more step.

b. Brings the trailing foot alongside the leading foot and marches in place at normal cadence.

c. Raises each foot about 2 inches off the ground while marching in place.

d. Allows the left arm to swing naturally.

e. Marches at the position of attention.

6. "**Group, halt.**" On the command, "*Group, halt,*" the soldier—

a. Takes one more step.

b. Brings the trailing foot alongside the leading foot and halts.

c. Maintains position of attention

INSPECTIONS

There are four inspection periods within the first nine weeks of training.

IN1. The first inspection is a working inspection covering inspection of bunks, wall lockers, individual clothing and equipment. It will take place at the beginning of the cycle and give soldiers an introduction to Army inspection procedures.

IN2. The second inspection is a stand-by inspection. Items to be inspected include: bunks, wall lockers, individual clothing and equipment.

IN3. The third inspection period is an in-ranks inspection, and covers open and close ranks, inspection arms, port and order arms, and proper courtesy in an in-ranks inspection.

IN4. The fourth and final inspection period in basic training is a stand-by inspection. Items to be inspected include: Class A uniforms, weapons, protective masks, bunks, wall lockers, and common areas.

Personal Appearance And Uniform

Personal appearance is important—it demonstrates the pride and self-discipline you feel as a soldier in the United States Army. Being neat and well-groomed contributes to the esprit in your unit. Your uniform should fit well and be clean, serviceable, and pressed as necessary.

Your uniform is only part of your appearance. To really look like a soldier, you need to be physically fit, meet acceptable weight standards, and have a neat hairstyle in accordance with Army regulations.

Hairstyle

Many hairstyles are acceptable in the Army for soldiers who have completed basic combat training.

Male Personnel. The hair must not fall over the ears or eyebrows or touch the collar (except for closely cut hair at the back of the neck). Hair should be tapered, except that "block cut" fullness in the back is permitted in moderate degree. Neither the bulk nor length of hair may interfere with the wearing of military headgear. Sideburns must be neatly trimmed, not flared, and must not extend downward beyond the lowest part of the exterior ear opening. The face must be clean-shaven, except that mustaches are permitted. If a mustache is worn, it must be neatly trimmed. No part of the mustache will cover the upper lip line or extend horizontally beyond or below the corner points of the mouth where the upper and lower lips join.

Female Personnel. The hair must not fall over the eyebrows and must not extend below the bottom edge of the collar. Neither the bulk nor length of hair may interfere with the wearing of military headgear. Any hair-holding ornaments, such as barrettes or hairpins, must be of a natural hair color or transparent. Makeup and nail polish should be conservative and complement the uniform. Unless directed to wear another type of footwear, female personnel may wear pumps with all uniforms except field uniforms.

Jewelry

A wrist watch, identification bracelet, and up to two rings (a wedding set is considered to be one ring) may be worn with your uniform as long as they are conservative and tasteful. You may wear a religious medal on a chain

around your neck provided neither medal nor chain can be seen.

Body Piercing

No attaching, affixing, or displaying objects, articles, jewelry or ornamentation to or through the skin while in uniform, in civilian clothes while on duty, or civilian clothes off duty on any military installation or other places under military control except for earrings for females. Females may wear any type of earrings off duty, on or off military installations.

Tattoos

Visible tattoos or brands on the neck, face, or head are prohibited. Tattoos or brands on other areas of the body that are prejudicial to good order and discipline are prohibited. Additionally, any type of tattoo or brand that is visible while wearing a Class A uniform and detracts from soldierly appearance is prohibited.

Uniform Wear and Maintenance

You are responsible for keeping your clothing in good serviceable condition. Clean your clothing regularly, keep it in good repair, and store it properly. Carrying large or heavy objects in your pockets is likely to change the shape of your tailored clothing.

Follow the cleaning and care instructions attached to most clothing. Clean your clothing as soon as possible after it becomes soiled. Dirty clothing wears out more quickly than clean clothing because dirt cuts fibers and holds in moisture from perspiration. Coated clothing such as ponchos and raincoats should be wiped clean or washed

by hand with a soft brush and warm soapy water. These items should be thoroughly rinsed and hung up to air-dry.

If you need to press clothing, be sure it is clean and that the iron is not too hot. To press cotton clothing, dampen the surface of the cloth, then apply the iron directly. Before storing clothing, be sure it is clean and dry.

Boots

New boots should fit properly when you receive them. They should have a chance to air out between wearings, so you should wear one pair one day and another pair the next.

Scrape dirt or mud from boots and wash with just a little water and soap. Wipe insides dry with a clean cloth and remove all soapsuds from the outside. Stuff papers in the toes and let boots dry in a warm, dry place. Do not put them in the hot sun or next to a strong source of heat. Polish after boots are dry. Heels of boots should be replaced after wear of $\frac{7}{16}$ of an inch or more.

Insignia Placement

Each soldier is responsible for having the correct insignia properly placed on their uniform, as follows:

Shoulder Sleeve Insignia. Soldiers in both basic combat training and advanced individual training who are in one of the following categories may wear organizational shoulder sleeve insignia (shown in Figure 4-16). This insignia will be worn centered on the left sleeve, $\frac{1}{2}$ inch below the top of the shoulder seam on all Army green

uniform coats. Subdued shoulder sleeve insignia will be worn on all field and work uniforms.

- Army National Guard (ARNG) and Reserve (USAR) trainees are authorized to wear the insignia of their parent ARNG or USAR organization from the start of training.
- Unit-of-choice trainees are authorized to wear, from the start of training, the insignia of the specific unit for which they enlisted.

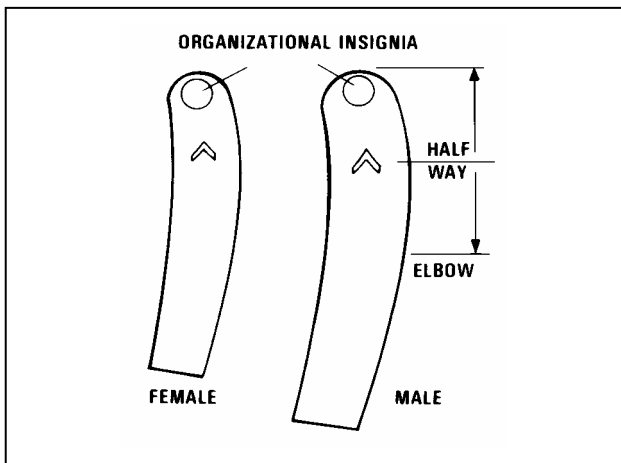

Figure 4-16 Shoulder sleeve Insignia of Current Unit.

Distinguishing Insignia. The "US ARMY" insignia is worn immediately above and parallel to the top edge of the left breast pocket. This insignia consists of black, 3/4-inch high block letters on a 1-inch wide by 4 1/2-inch long (or to the edges of the pocket flap) strip of olive green cloth.

The name tape is worn immediately above and parallel to the top edge of the right breast pocket of all field and work uniform coats and shirts. It consists of black letters on a 1-inch wide by 4 1/2-inch long (or to the edges of the pocket flap) strip of olive green cloth.

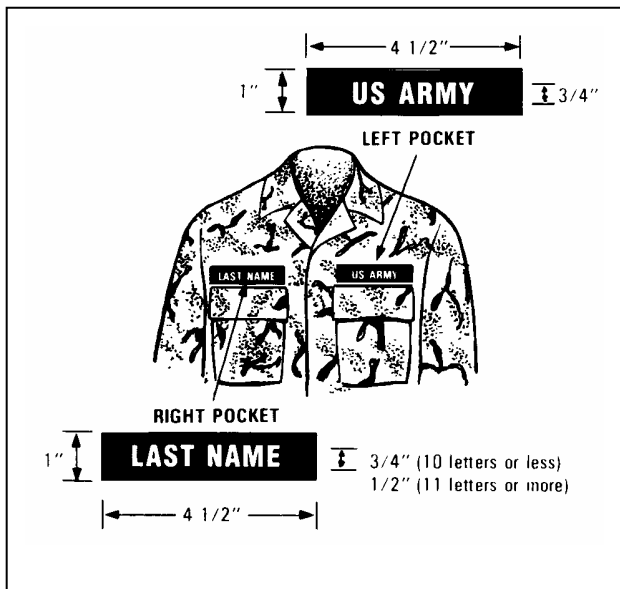

Figure 4-17. Distinguishing insignia.

Names ten letters or less will be printed in 3/4-inch high Franklin Gothic Condensed. Names eleven letters or more will be printed in 1/2-inch high Franklin Gothic Extra Condensed (Figure 4-17). The name and US Army tapes will be the same length.

Rank Insignia. Soldiers will wear subdued pin-on rank insignia centered on both collars of all BDU uniforms and field jackets. The center line of the insignia will be 1 inch from the collar point and will bisect the points of the collar (Figure 4-18).

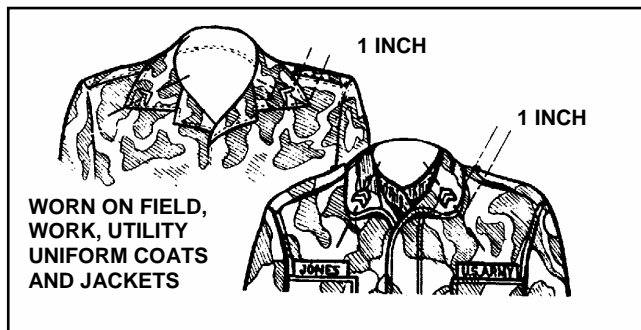

Figure 4-18. Rank insignia.

The Army green shirt may be worn with or without the Army green coat. Specialists 4 and below must always wear their rank insignia on the collars of the green shirt (Figure 4-19). Corporals and above must wear shoulder board rank insignia.

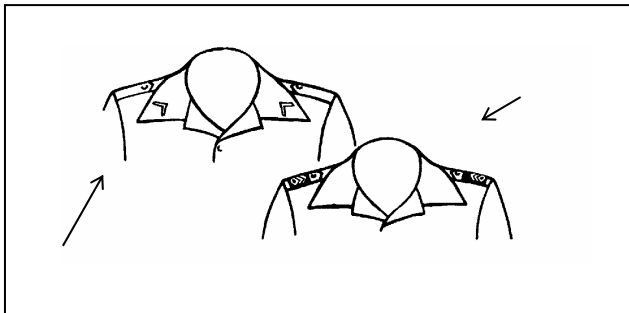

Figure 4-19. Rank insignia, enlisted

US and Branch Insignia. During initial entry training, males will wear the "US" insignia on both collars. The bottom of the insignia disk will be 1 inch above the notches on the collar, with the center line of the insignia bisecting the notch and parallel to the inside edge of the collar on the Army green, Army white, and Army blue uniform coats (Figure 4-20). After completing AIT or one-station unit training (OSUT), male soldiers will wear MOS branch insignia on their left collar.

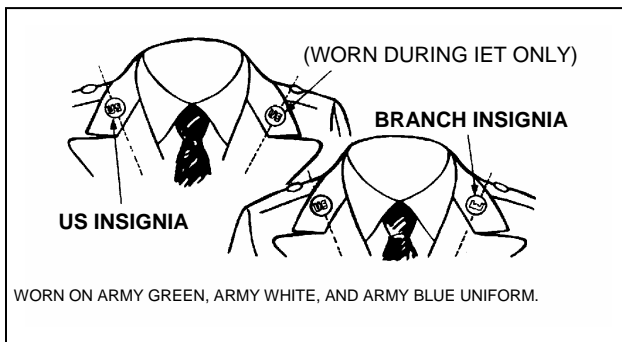

Figure 4-20. US and branch insignia, enlisted male

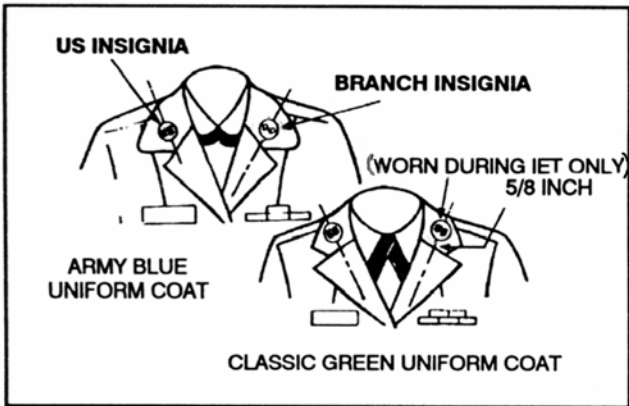

Figure 4-21. US and branch insignia, enlisted female.

During initial-entry training, females will wear the "US" insignia on both collars. The bottom of the insignia disk will be worn 1 inch above the notches on the collars, with the center line of the insignia bisecting the notch and parallel to the inside edge of the collar on the Army green pantsuit jacket, and Army green, Army white, and Army blue uniform coats (Figure 4-21). The bottom of the insignia disk will be 5/8 inch above the collar lapel seam on the female classic green uniform coat. After completing AIT or OSUT, female soldiers will wear MOS branch insignia on their left collar.

Belts and Buckles

The web belt will be a 1 1/4-inch web or woven elastic web belt of black color with a black or brass tip. A plain-faced, oval-shaped, solid brass buckle, 2 1/4 inches long and 1 3/4 inches wide, will be worn on the web belt with the dress

uniform. Only the brass-tipped belt is authorized with this buckle. The brass tipped belt will be worn flush with the brass buckle. The black, open-faced buckle, 1 11/16 inches long and 1 5/8 inches wide, will be worn on the belt with all field and work uniforms. The tipped end of the belt will pass through the buckle to the wearer's left and will not extend more than 2 inches beyond the end of the buckle.

INDIVIDUAL EQUIPMENT

Web Gear and Canvas Equipment

Vigorously wash soiled canvas items in a container of warm water containing soap or detergent. Scrub stubborn spots with a white or colorfast cloth using warm soapy water. Do not use chlorine bleach, or cleaning fluids. Stretch the web gear back to its original shape while it dries. Dry the equipment inside or in the shade. Direct sunlight will discolor it. Never wash or dry web gear in commercial or home automatic laundry equipment.

Protective Clothing

You will be provided with special clothing for cold-wet, cold-dry, and hot climate conditions. This clothing will help protect you from the weather, insects, and other effects. In addition to this special clothing, you will have a helmet and other accessories:

Helmet. Wear the helmet to protect yourself against artillery fire, grenades, and ricocheting bullets. You may wear the helmet over the cotton utility cap or over the poncho hood. Do not use the helmet as a seat, shovel, or hammer.

Chin Strap. The chin strap holds the helmet in place during rigorous activities. Place and center the chin strap

on your chin, and adjust the tension until it feels comfortable. The chin strap should be cleaned with soap and warm water and air-dried.

Camouflage Cover. Attach the helmet camouflage cover by placing it over the helmet and tucking the cover flaps inside the helmet. The cover has slits for inserting twigs or foliage for additional camouflage.

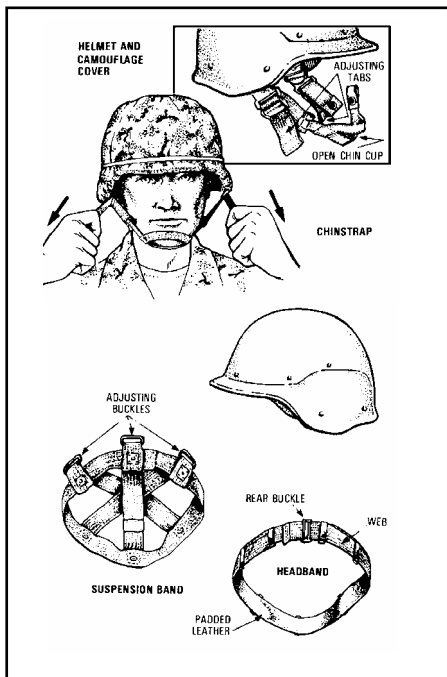

Figure 4-22. Helmet and accessories

Helmet Accessories. The helmet contains a suspension system of cotton webbing. You can adjust the webbing to the right height by adjusting the buckles. The webbing is attached to a leather-lined headband, which you can also adjust to fit your head (Figure 4-22).

Load-Carrying Equipment

The all-purpose lightweight carrying equipment (ALICE) is made up of components for the fighting load and additional components for the existence load. You can use these components in all environments (Figures 4-23).

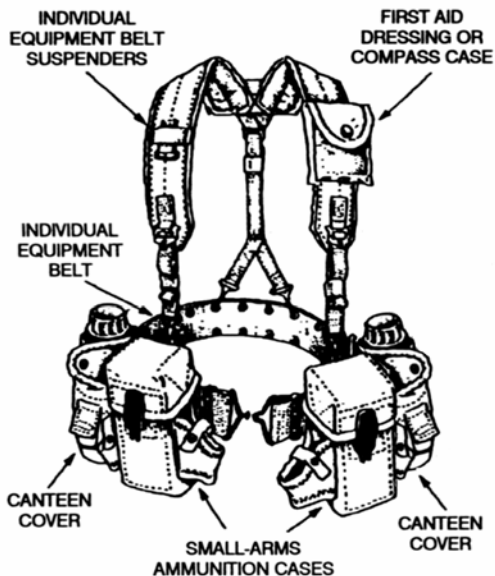

Figure 4-23. Load-carrying equipment.

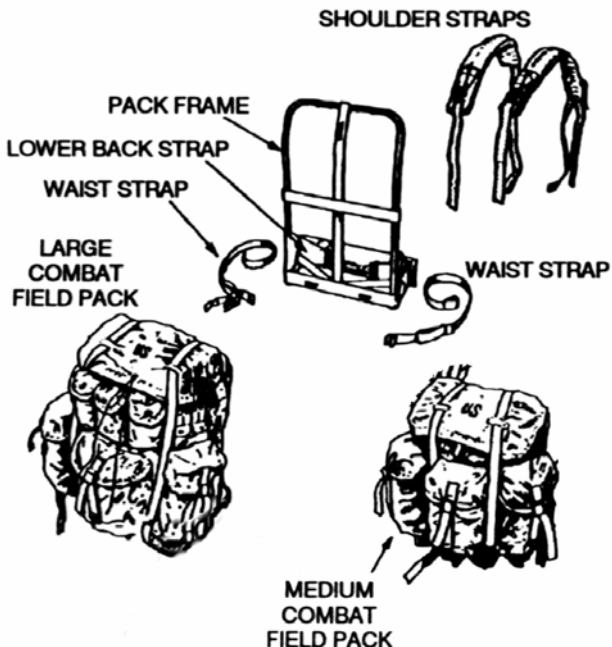

Figure 4-24. Load-carrying equipment.

Bivouac Equipment

Poncho. The poncho is made of coated nylon and is waterproof. It can be used as a rain garment, ground cloth, or sleeping bag. It can also be used to make a shelter or tent (Figure 4-25). Two ponchos can be snapped together to make a two-person shelter. If possible, air-dry the poncho before folding it up.

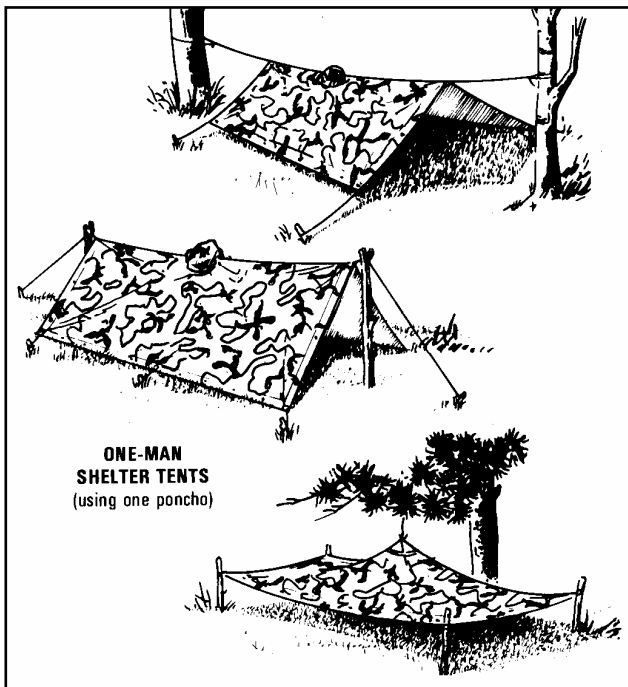
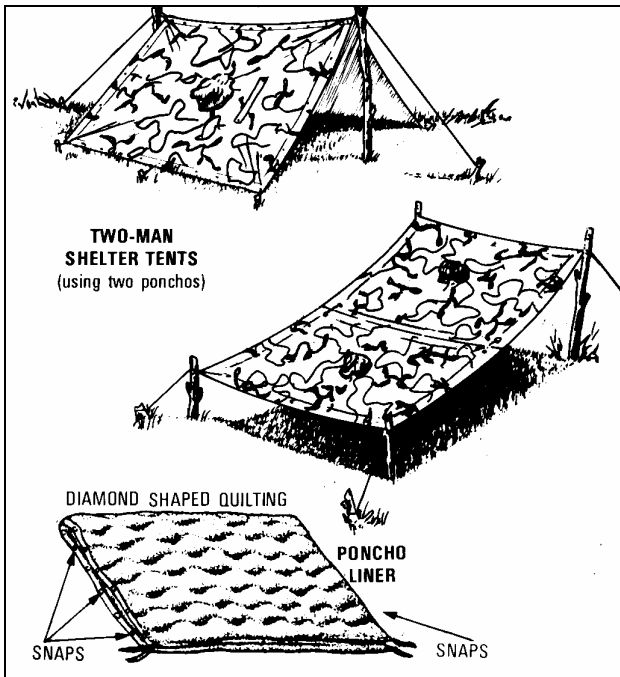

Figure 4-25. Miscellaneous poncho shelters.

Poncho Liner. The liner is a lightweight padded panel about the same size and shape as the poncho. It can be attached to the poncho with its tie tapes and snap fasteners. It can also be used as a blanket. The liner can be hand-washed with warm soapy water. It should not be dry-cleaned.



**Figure 4-26. Miscellaneous poncho shelters
(continued).**

Shelter Half. The shelter half is made of water-repellent, mildew-resistant material. It is issued to you with five tent pins, a guy line, and a three-section tent pole. Two shelter halves joined together can make a two-person shelter as shown below (Figure 4-26).

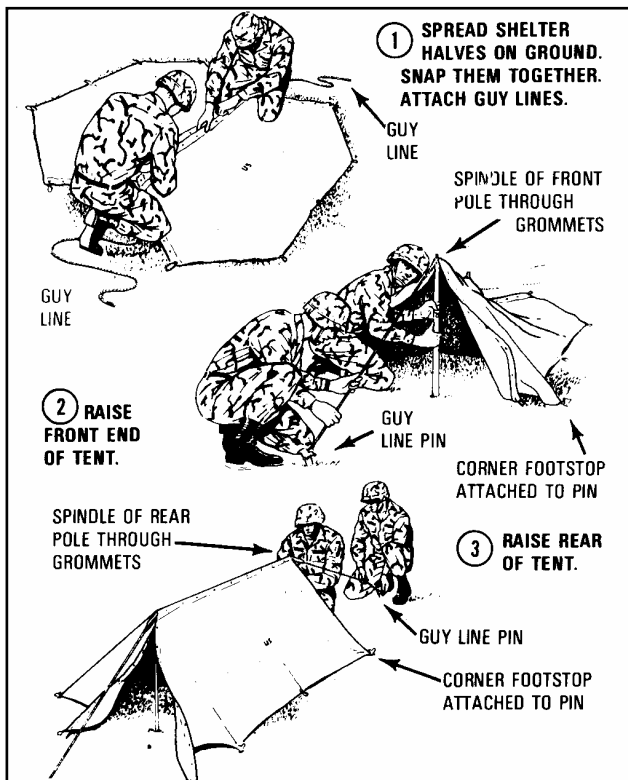
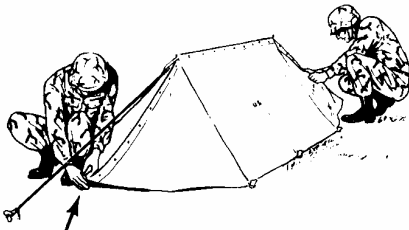
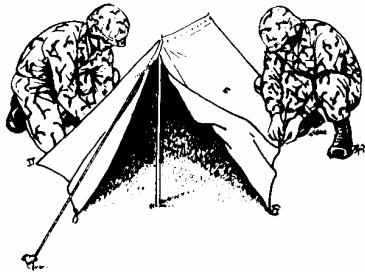

Figure 4-27. Procedures for pitching shelter half tent

4 DRIVE SIDE CENTER PINS AND ATTACH FOOTSTOPS.



END FOOTSTOP
ATTACHED TO PIN

5 DRIVE END PINS AND ATTACH FOOTSTOPS.

END SNAPS
MAY BE
CLOSED OR
FOLDED
BACK FOR
VENTILATION.

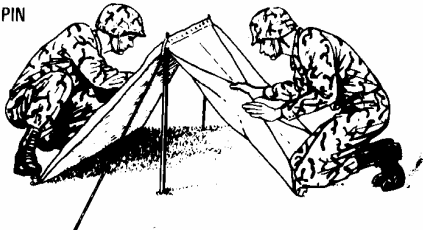

Figure 4-28. Procedures for pitching shelter half tent

Army Physical Readiness Training (PRT)

Military physical readiness training must seek to attain the development of every soldier's physical attributes to the fullest extent of their potential. This will build confidence and encourage them to successfully perform their duties under any and all circumstances.

Phases of Physical Readiness Training (PRT)

Army Physical Readiness Training (PRT) programs are designed to account for all soldiers who enter the army, and take into consideration that all soldiers come into the army with varying capabilities. If the training is focused to the level of the least fit, most soldiers will not be challenged. If it is focused to the soldiers who are in better shape, then the least fit soldiers are at risk of injury. Therefore, the ARMY has established two PRT phases, toughening and conditioning that are appropriate for training soldiers of various physical capabilities to achieve physical readiness and reduce the chances of injury. The Army PRT model begins with the toughening phase that builds on the soldier's existing strength, mobility and stamina, and progresses to the conditioning phase that will enable the soldier to achieve physical readiness and perform all expected duties.

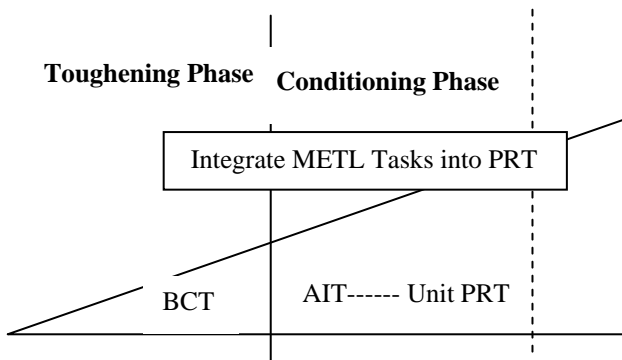

Fig. 4-29 Phases of PRT

Toughening Phase. The purpose of the toughening phase is to develop foundational fitness and fundamental skills. In this phase, soldiers gradually become proficient at managing their own body weight. Through exercises such as calisthenics, movement drills, grass drills and dumbbell drills, soldiers learn essential skills such as jumping, landing, lunging, bending, reaching and lifting. Their stamina improves through progressive PRT activities. A variety of training events with precise standards of execution ensures that the bones, muscles, and connective tissues gradually “toughen” rather than break. The primary goal of the toughening phase is to prepare the soldier’s body to enter the conditioning phase. The toughening phase also enables experienced soldiers who have been injured or inactive to recover and rebuild foundational fitness in order to re-enter the conditioning phase.

Conditioning Phase. The purpose of the conditioning phase is to develop a high level of physical readiness appropriate to duty position. In this phase, events become more demanding. More advanced calisthenics and dumbbell drills are added to increase the resistance of fundamental movements. Guerilla drills are also included to develop functional jumping and lifting skills. Interval runs are added to further develop aerobic endurance. Circuits that build strength and challenge individual movement techniques also add variety to this phase. When you are physically mission-capable and all of your individual and unit physical readiness goals have been achieved, continued training emphasizes advanced skills and sustainment of physical readiness.

Soldiers in BCT are in the toughening phase throughout much of their training. Toward the end of BCT and during AIT, soldiers enter the conditioning phase of PRT.

COMPONENTS OF PHYSICAL READINESS

Military physical readiness is the ability to meet the physical demands of any combat or duty situation, accomplish the mission and still have a reserve of strength. It is essential to combat readiness. The diagram below illustrates the three interactive components of military physical readiness: strength, endurance and mobility.

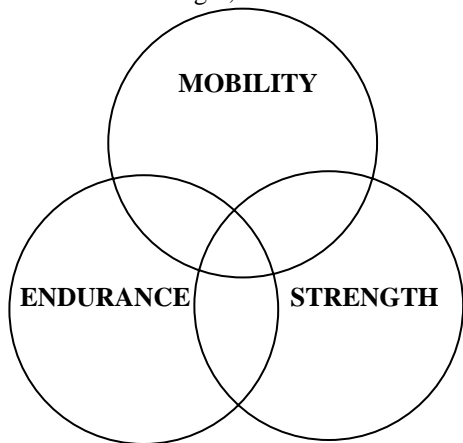

Fig. 4-30 Military Physical Readiness Components

- a. **Strength** is the ability to overcome resistance.
- b. **Endurance** is the stamina to sustain activity.
- c. **Mobility** is the proficiency with which you move your body.

PRINCIPLES OF PRT

The principles of progression, variety and precision are imperative to the development of an effective PRT program. These principles apply to all soldiers at all levels of physical readiness.

Progression. Physical readiness improvement is dependent upon an increase in your physical work.

Variety. Performing different training activities balances your program, providing a more complete training effect.

Precision. Perform all exercises with emphasis on correct posture and execution to ensure optimal physical readiness improvement and avoid injury.

SUMMARY. All PRT, whether performed individually or as a group, must contribute to the improvement of the physical ability of the entire unit to successfully perform all mission tasks. Any PRT that results in numerous injuries is detrimental to this goal. FM 21-20 provides guidance for conducting safe and sound PRT that challenges soldiers without undue risk of injury.

Training Injuries

Blisters. Seek medical help if the blister is red or painful.

Corns and Calluses. To prevent corns and calluses, use moleskin padding. *DO NOT* treat these with medicated pads.

Arch Pain. To ease arch pain, use an ice pack. As a preventive measure, apply liniment before exercise and use arch supports.

Sprains. Apply an ice pack to the ankle for 15 to 20 minutes; repeat after 1 hour. Seek medical help if swelling or discoloration develops. To strengthen the ankle, exercise it with toe-to-heel walking, one-legged activities, and resistance exercises using boots, helmets, or socks with stones as weights.

Achilles Tendinitis and Shin Splints. Use an ice pack after exercise. As a preventive measure, improve tendon flexibility with curb and wall stretches.

Knee Pain. To avoid knee pain, do straight leg lifts. Improve flexibility by pulling the heel to the opposite buttock.

Hamstring Pulls. Use an ice pack after exercise. Improve flexibility—

- By sitting with one leg straight and the other bent with the sole of the foot against the knee of the outstretched leg, reach for the outstretched foot.
- By standing near a wall and leaning into it with legs crossed at ankles.

Lower Back Pain. To prevent low back pain, improve flexibility. Bend forward and backward. Tilt your pelvis. While lying on the floor, bring your knees up to your chest, hold them with your hands, tuck your chin in, and lift your head, neck, and shoulders off the floor. Strengthen your abdominals by doing curl-ups (partial sit-ups). Improve your posture by lifting with your legs, NOT your back, and by squatting and rising with a straight back.

Selecting the Proper Running Footwear

Determining Shoe Size. The first step to proper fitting is to measure both feet. Your footwear sales associate will measure both feet using the “Brannock Device.” Wear the socks you will run in when trying on running shoes. Walk and run in the shoe on a hard surface while trying them on. Buy shoes after being on your feet for a few hours. Make sure the shoes are comfortable when you buy them.

“Wet Test—What is my foot type?” Second, you can take the simple Wet Test to determine what kind of foot type you have and what shoe-shape you should look for. Basically, running shoes have one of three different shapes: straight; semi-curved; or curved. To take the test, wet your foot and then stand on any surface that will leave an imprint of your foot. (Example: Use a brown paper bag from the grocery store or dark construction paper). When you look at this imprint, you should find that you have one of the three most common foot types. While not every foot completely mimics these three types, you can still use the Wet Test to determine your general foot type and the shoe shape most likely to benefit your running.

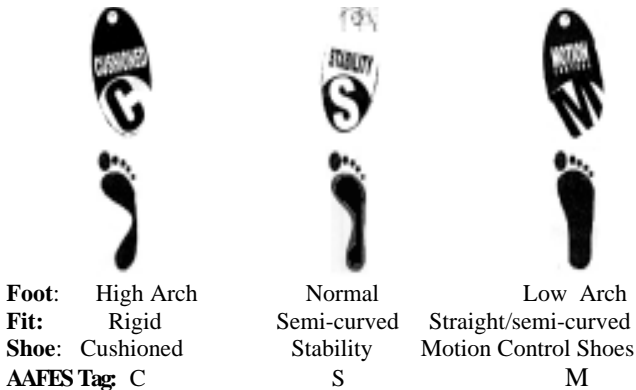

Figure 4-31. Example Foot Type Selection.

NOTE: Circle the foot type that matches your foot assessment results.

The High-Arched Foot

Foot Characteristics: A curved, high-arched foot is generally termed an under-pronated foot. This type of foot doesn't pronate enough so it's not an effective shock absorber.

Best Fit: Curved shape

Best Shoes: Cushioned ("C" tag) shoes with plenty of flexibility to encourage foot motion and plenty of mid-foot cushioning. Stay away from motion-control or stability shoes that reduce foot-mobility.

The Normal Foot.

Foot Characteristics: A normal foot lands on the outside of the heel, then rolls inward (pronates) slightly to absorb

shock. Runners with a normal foot and normal weight are usually considered biomechanically efficient and don't require motion-control shoes.

Best Fit: Semi-curved shape

Best Shoes: Stability shoes with moderate control features such as a two-density mid-sole. ("S" tag)

The Low-Arched Foot.

Foot Characteristics: This imprint usually indicates an over-pronated foot that strikes on the outside of the heel and rolls inward (pronates) excessively. Over time, this can cause many different kinds of over-use injuries.

Best Fit: Straight or semi-curved shape

Best Shoes: Motion-control shoes ("M" tag) or stability shoes ("S" tag) with firm mid-soles and control features that reduce the degree of pronation. Stay away from highly cushioned curved shoes that lack stability and control.

Sports Bra Selection

If your chest measures 30-32 inches, select a small sports bra. If your chest measures 34-36 inches and is a B or C cup, select a medium sports bra. If your chest measures 38-40 inches, select a large sports bra. If your chest measures 42-44 inches and is a D or DD cup, select an extra large sports bra.

NUTRITION

Proper nutrition is the single most important factor in developing a healthy lifestyle. Maintaining proper

physical fitness and body fat percentage is an individual responsibility and is critical to your duty performance. The best way to ensure you are performing at your physical peak is to have a good understanding of nutrition. Just like a car needs fuel to operate, the body needs fuel too; and not just any fuel. Putting the wrong fuel into a car will result in sluggish and poor performance and putting the wrong fuel in your body will produce the same results. You must fuel your body with the right foods to ensure optimal performance. Good nutrition is not complicated and is really a matter of self- discipline.

A well-balanced diet must provide approximately 50 nutrients, which are all available in Army dining facilities. Most foods contain more than one nutrient, but no single food contains all of the essential nutrients in the right amount. By eating a variety of foods you are less likely to develop a nutrient deficiency. The easiest way to know you are getting all of the right foods in the right amounts is to follow the guidelines of the food pyramid.

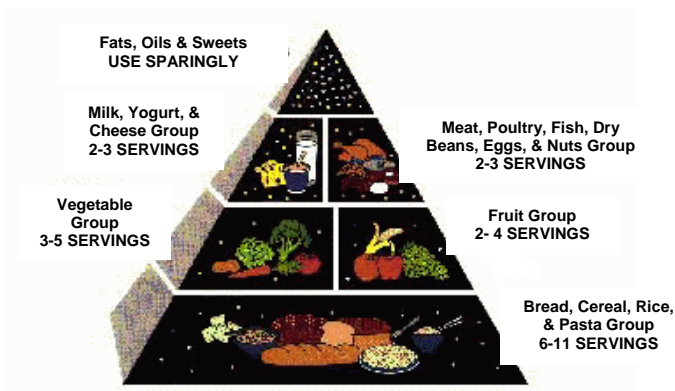

Figure 4-32

The foundation for all well balanced diets is complex carbohydrates. The body converts carbohydrates into glycogen (your energy source). Only a small amount of glycogen can be stored so it must be replenished daily.

Bread, Cereal, Rice, & Pasta Group

- Foundation of the Food Pyramid
- Excellent source of complex carbohydrates
- Largest % of diet
- 6-11 servings per day

Vegetable Group

- High in vitamins & minerals
- Excellent fiber source
- Most people fail to eat enough
- 3-5 servings per day

Fruit Group

- High in vitamins & minerals
- Good water source
- Eat a variety of fruits
- 2-4 servings per day

Milk & Cheese (dairy) Group

- Great source of calcium and protein
- Can also be high in fat
- Low & No fat choices
- 2-3 servings per day

Meat, Poultry, Fish, Beans, Nuts, & Eggs

- Best source of protein
- Can also be high in fat

- Eat mostly chicken, turkey and fish
- 2-3 servings per day

Fats, Oils, Sweets, & Alcohol

- Watch for *hidden* fats (salad dressing, fried foods, etc.)
- Prevent the body from utilizing nutrients
- Alcohol has no nutritional value
- Eat sparingly

To ensure you are eating a performance diet, follow these basic guidelines:

1. Eat a variety of foods
2. Maintain your ideal body weight
3. Lower your cholesterol (eat low fat foods)
4. Increase starch and fiber
5. Avoid excess sugar and sodium
6. Limit your alcohol consumption

SAFETY

Prevention of Hot and Cold Weather Injuries

Prevention of Cold Weather Injuries

The key to keeping warm in cold climates is to wear the correct clothing. Keep your clothes clean and dry. Wear your clothes in loose layers, and avoid overheating. The factors shown in Figure 4-33 increase the likelihood of cold (and heat) injuries.

Buddy System. Use the buddy system by watching what your buddy does and how he/she wears their uniform. If you see a

cold injury develop, take immediate first aid measures.

▪ Fever	▪ Exertion
▪ Recent illness or injury	▪ Fatigue
▪ Overweight	▪ Heavy meals
▪ Previous cold injury	▪ Use of alcoholic beverages
▪ Dehydration	▪ Feverish Reactions to immunizations

Figure 4-33. Factors that increase the likelihood of cold or heat injuries.

Dehydration. You can dehydrate rapidly when exercising or working hard in extreme cold. Sip liquids regularly. Refer to the fluid replacement guidelines (Figure 4-34).

Layered Clothing. Do not wear too much clothing, because that will make you sweat. If you get wet from sweating, you will get cold. Before you begin to sweat, loosen your clothing. Open your uniform to allow cool air in next to your body. If you continue to sweat, remove one or more layers of clothing. Do not use blousing bands as they will restrict the flow of blood in your legs. Instead, blouse your trouser legs inside your boots. If you develop a cold, use a handkerchief to prevent infecting fellow soldiers when you cough or sneeze. When entering a warm building, always remove your field jacket and gloves.

Scarf. The wool Army scarf can be used to keep your neck warm, to cover your face against the cold and wind, or as a stocking cap (by placing the open end over your head).

Gloves. During extreme cold, use the glove as a mitten, which will keep your hands warmer. To do this, withdraw your fingers from the fingers in the black leather gloves and into the palm of your hand. Do this for short periods of time until your hands are warm. Also, in case you lose the first pair or get them wet, always have an extra pair of black leather gloves and wool inserts.

Socks. Your feet are harder to keep warm than any other part of your body. Especially try to keep them dry. When they do get wet, put on dry socks. Massage and apply foot powder to your feet before putting your boots back on. If your feet are still cold, do exercises such as stomping your feet, wiggling the toes inside the boots, bending at the knee, or running in place.

Personal Cleanliness. Keep yourself clean. Sweat-dampened clothing increases your vulnerability to trench foot and to worse cold weather injuries. Change socks and underwear regularly. Carry extra pairs of socks. On cold weather hikes, place damp socks under your arms between your field jacket and shirt. This will help dry the socks so you can rotate them. (When carrying a rucksack, place damp socks on your shoulders between your shirt and outer garments. This helps dry the socks and cushion the weight of the rucksack. Place your clean clothing with you in the sleeping bag, positioning them to support the small of your back or using them as a pillow (inside). Not only does this add to your sleeping comfort, but your clothes will be warm in the morning. Do not wrap feet or other body parts in plastic to keep warm. Body heat causes moisture to collect, which can cause serious injuries.

Clean Clothing. Always keep your clothes clean. Dirt and grease will clog the air spaces in your clothing and reduce the natural insulation. Before going to bed at night, clean your body with soap and water and dry yourself thoroughly.

Sleeping Bag. Your sleeping bag and foam pad will keep you warm and comfortable while you sleep. Avoid sweating inside your sleeping bag by wearing the least amount of clothing you can and still keep warm. Do not keep your face inside the bag. Water vapor (breath) escaping from your mouth will cause your bag to become damp. If your face is cold, cover it with your scarf or towel. When your bag is not being used, open it so that fresh air can get into it. Always carry your sleeping bag in its waterproof bag.

Fire. When safety approved heating devices are used in warming tents, ensure there is adequate ventilation. Do not put any type flame in tents or under ponchos to keep warm. This can lead to loss of shelter or even to loss of life. Your drill sergeant will use the following evaluation guide to test your knowledge of protection against the cold:

Evaluation Guide

Protect Yourself Against Cold

Performance Measures

The soldier describes the following protective measures and the reasons for them:

1. Wear several loose layers of clothing. This traps air, which insulates the body.
2. Remove a layer or two of clothing before doing heavy work. Replace clothing when heavy work is completed. Wet or damp clothing cannot keep the body warm.

3. Exercise the feet, hands, and face. This increases blood circulation and heat production.
4. Prevent dehydration. Dehydration keeps the body from being able to maintain a safe body temperature.
5. Change your socks. Rotate boots if possible. Moisture increases the risk of frostbite and trench foot.

Prevention of Hot Weather Injuries

Even if you are in good physical condition, your body must acclimatize before you can do heavy work in hot temperatures. Most of this acclimatization takes place automatically during the first five to seven days, as your workloads and exposure to heat are gradually increased. Never forget that heat can be a killer. Leaders should be considerate of subordinates who work in high temperatures, and should heed warnings sent down through command channels. Figure 4-34 illustrates guidelines for fluid intake and recommended activity levels based on heat.

Urine. Sometimes, you can use your urine color to determine your approximate level of hydration. The clearer your urine, the more hydrated you are. The darker your urine, the more water you need to drink. Note that this is only a guideline, and should not be taken as a rule because certain foods and dietary supplements can impact on urine color.

Fluid Replacement Guidelines for Warm Weather Training (Unacclimated/Acclimated Soldier wearing BDU, Hot Weather).							
Heat Category	WBGT Index, °F	EASY WORK		MODERATE WORK		HARD WORK	
		Work/Rest	Water/Fluid Intake, qt/h	Work/Rest	Water/Fluid Intake, qt/h	Work/Rest	Water/Fluid Intake, qt/h
1	78-81.9	NL	½	NL	¾	40/20 min	¾
2	82-84.9	NL	½	50/10 min	¾	30/30 min	1
3	85-87.9	NL	¾	40/20 min	¾	30/30 min	1
4	88-89.9	NL	¾	30/30 min	¾	20/40 min	1
5	>90	50/10 min	1	20/40 min	1	10/50 min	1

• The work rest times and fluid replacement volumes will sustain performance and hydration for at least 4 hours of work in the specified heat category. Individual water needs will vary ± ¼ qt/hour.
 • NL=No limit to work time per hour. Rest means minimal physical activity (sitting or standing) and should be accomplished in shade if possible.
 • Caution: Hourly fluid intake should not exceed 1 ½ quart.
 • Caution: Daily fluid intake should not exceed 12 quarts per training day.
 • Caution: MOPP gear adds 10°F and Body Armor adds 5°F to WBGT Index.
 • Examples:

EASY WORK		MODERATE WORK		HARD WORK	
• Weapon Maintenance	• No Load	• Foot Marching Loose Sand at 2.5 mph,	• Foot Marching Hard Surface at 3.5 mph,	• Foot Marching Hard Surface at 3.5 mph,	• 40 lb Load
• Foot Marching Hard Surface at 2.5 mph,	• Foot Marching Loose Sand at 2.5 mph,	• Foot Marching Hard Surface at 3.5 mph,	• 40 lb Load	• Foot Marching Loose Surface at 12.5 mph with	• 40 lb Load
• Manual of Arms	• PT	• Patrolting	• Individual Movement Techniques,	• Running (sustained)	• Obstacle/Confidence
• Marksmanship Training	• Drill and Ceremony	• (i.e. low crawl, high crawl)	• Positioning Position Construction	• Course	

*Quarts Per Hour
 FJ Chart 4
 30 March 2006

Figure 4-34. Fluid Replacement Guidelines and Activity Limitations.

ACTIVITY LIMITATIONS BY HEAT CATEGORY		
HEAT CATEGORY	UNIFORM RESTRICTIONS	ACTIVITY LEVELS
I	NO RESTRICTIONS	NO RESTRICTIONS
II	NO RESTRICTIONS	MAY CONDUCT HARD WORK IN DIRECT SUNLIGHT, AT REDUCED PACE AND INTENSITY.
III	SOLDIERS UNBLOUSE TROUSER LEGS UNBUCKLE WEB BELTS.	MAY CONDUCT HARD WORK AT REDUCED PACE AND INTENSITY, AVOID ACTIVITY IN DIRECT SUN. WATCH FOR CUMULATIVE EFFECT.
IV	SOLDIERS UNBLOUSE TROUSER LEGS UNBUCKLE WEB BELTS; HELMETS ONLY WORN WHEN NEEDED FOR SAFETY PURPOSES.	ACCLIMATED SOLDIERS HARD WORK MAY CONTINUE AT REDUCED PACE AND INTENSITY USING APPRO. PRIVATE WORK/REST CYCLE FOR CAT IV. UNACCLIMATED SOLDIERS SUSPEND ALL HARD WORK. OTHER OPERATIONS MAY CONTINUE USING APPROPRIATE WORK/REST CYCLE FOR CAT IV.
V	SAME AS CAT IV	SUSPEND HARD WORK. MAY CONDUCT MODERATE WORK AT REDUCED PACE AND INTENSITY USING APPRO. PRIVATE WORK/REST CYCLE FOR CAT V.

The factors shown in Figure 4-34 also increase the chance of heat injury. The key to preventing heat injuries is to maintain a normal body temperature. You can protect yourself from the likelihood of heat injury by—

- Drinking plenty of fluids to replace those lost through increased perspiration.
- Reducing exposure to heat during the hot part of the day. Plan PT, road marches, patrols, and so forth for early morning or evening activity.
- Selecting clothing wisely. Wear loose clothing that allows blood to circulate more easily and perspiration to evaporate more freely. Wearing loose clothing and a head covering insulates you from the sun and heat.
- Using a buddy system to identify potential victims of heat before injuries occur.
- Taking breaks frequently and drinking plenty of fluids, if you must work during periods of excessive heat.

Your drill sergeant will use the following evaluation guide to test your knowledge of how to protect yourself against heat:

Evaluation Guide

Protect Yourself Against Heat

Performance Measures

1. The soldier drinks plenty of water.
 - a. In a chemical environment, drink additional water.
 - b. Drink smaller quantities of water frequently.

- c. Drink extra water before an attack or mission.
2. The soldier rests whenever possible. Rest breaks give your body a chance to cool off.
 3. The soldier eats regular meals. Eat three meals daily. Eat something each meal, even if you're not hungry.
 - a. Food replaces salt lost through heavy sweating.
 - b. Military rations contain all the salt your body requires.

Prevention of Hyponatremia

What is it? Hyponatremia, or water intoxication, is a condition that occurs when there is a lack of salt in the blood, caused by inadequate excretion of water or by excessive water in the circulating blood stream.

Symptoms. Symptoms of hyponatremia include repeated vomiting, seizures, and high output of clear urine. In severe cases, you may develop confusion, leading to muscle excitability, convulsions, coma, and possible death.

Symptoms may mimic heat exhaustion. If there is no improvement in 30 minutes, and the soldier does not improve to 100% within 60 minutes, then treat the soldier like a heat casualty. When in doubt . . . regardless . . . evacuate.

Prevention.

- Drink no more than 1 and ½ quarts of fluid per hour.
- Daily water intake should not exceed 12 quarts per training day.

- Drink a sports drink or electrolyte replacement fluid if possible at meals.
- Indicate the quarts of fluids consumed per hour on fluid intake cards.

FIELD AND PERSONAL HYGIENE

Disease Prevention

You can best do your job in the Army if you are free from disease. There are several simple things you can do to prevent disease in yourself and others.

Protect Yourself Against Respiratory Disease. The air you breathe carries many diseases. Most of these diseases, such as colds, will simply make you miserable and increase the difficulty of doing your job. Others, such as the flu, can be severe enough to kill. To keep from getting respiratory diseases—

- Avoid soldiers who are sick, if possible. Talk sick soldiers into going on sick call.
- Avoid using borrowed towels, caps, or anything else that others have handled.
- Provide an opening for fresh air into your fighting position or shelter. Fresh air dilutes contaminated air and carries much of the contamination away.

Follow Waste Disposal Procedures in the Field. The main reason for burying wastes is to prevent the breeding of flies. Flies can spread diarrhea and dysentery. Procedures for waste disposal are—

- Use the unit latrine for body wastes, or dig your own 1-foot deep by 1-foot wide cat hole. Cover it with dirt when you are finished.
- Use the garbage pit for other wastes or dig your own garbage pit. Dig it deep enough to allow 4 inches of dirt to cover the garbage when you are finished filling the hole.

Prevent Skin Infections. Bathe frequently. If showers or baths are not available, use a washcloth daily to wash your genital area, armpits, feet, and anywhere else the skin is prone to collect moisture, such as between the thighs or under the breasts. Keep your skin dry. Use foot powder on your feet, especially if you have had fungal infections on the feet in the past. Use talcum powder in areas where wetness is a problem, such as between the thighs or under the breasts. Wear proper clothing. Loose-fitting uniforms allow for better ventilation; tight-fitting uniforms reduce blood circulation and ventilation. Avoid nylon or silk-type undergarments. Cotton is more absorbent and allows the skin to dry.

Prevent Dental Disease. Go to the dentist at least once a year for an examination and treatment. Brush your teeth at least once a day, preferably after every meal. Use dental floss at least daily. Rinse your mouth with water after brushing and flossing. Use toothpaste if it is available.

Prevent Genital and Urinary Tract Infections.

Male soldiers: Wash your genital area daily. Be sure to wash the head of the penis and, if you have not been circumcised, pull the foreskin back before washing. Protect yourself from venereal disease (VD) by using a

condom when having sex. Using a condom helps prevent VD transmission.

Female soldiers: wash your genital area daily. Don't use perfumed soaps or female deodorants in the field; they may cause irritation. Protect yourself from VD by insisting that your sex partner use a condom. Using a condom helps prevent VD transmission. Don't douche unless directed to by medical personnel. In the field, female soldiers may drink too little fluid and hold their urine due to lack of privacy. This increases the chance of developing a urinary tract infection. Try to drink extra fluids, even when the weather is not hot. Urinary tract infections are among the most frequent medical problems female soldiers experience in the field.

Always Wash Your Hands Before Eating. Hands come into contact with many sources of bacteria. Some sources of contact are the latrine door, your friend's hands, your nose, weapons and ammunition, and dirt and dust.

Apply Insect Repellent. Biting insects are a source of discomfort, minor pain, and skin irritation. You can protect yourself against insects by applying insect repellent, taking malaria pills, and washing yourself and your uniform. When you use insect repellent—

- Apply it in spray or lotion form to all exposed skin. Do not get the repellent in your eyes.
- Apply it to your ankles to prevent ticks and mites from creeping between your uniform and your boots. Blouse your uniform inside your boots to further reduce the risk.

- Apply it to your shoulder blades where your shirt fits tightly enough for mosquitoes to bite through.
- Reapply some every two hours during strenuous activity and after crossing streams.

Straddle Trench. A straddle trench latrine is used on short bivouacs and FTXs. Two trenches per 100 males and three trenches per 100 females. The standardized measurements are 1'x 4'x 2'6".

GUARD DUTY

One of the most important duties you will perform in the Army is guard duty. In a combat zone, an alert, cautious guard can make the difference between life and death. However, guards are important everywhere due to the terrorist threats that can occur anywhere.

Interior Guard

An interior guard is set up by the commander of the military installation to protect property and to enforce specific military regulations. The main guard is a combination of patrols and fixed guard posts. Special guards are used to protect parks, boats, aircraft, and other places or property.

A guard on post is governed by two sets of orders: general orders and special orders. General orders outline the basic responsibilities of all guards, while special orders give details on how to perform on a particular post.

All interior guards must memorize, understand, and comply with the three general orders.

General Order Number 1 gives you responsibility for everything that occurs within the limits of your post while you are on duty. You must investigate immediately any unusual or suspicious occurrence on or near your post, provided you do not have to leave your post to do so. You must apprehend all suspicious persons, using only necessary force to overcome resistance. If you should require relief for any purpose, you must contact the commander of the relief for instructions.

General Order Number 1— *"I will guard everything within the limits of my post and quit my post only when properly relieved."*

General Order Number 2— *"I will obey my special orders and perform all my duties in a military manner."*

General Order Number 3— *"I will report violations of my special orders, emergencies, and anything not covered in my instructions to the commander of the relief."*

General Order Number 2 requires you to become thoroughly familiar with the special orders before you are actually posted. In addition to the special orders connected with your post, you are required to obey and carry out any orders or instructions from the commanding officer, field officer of the day, and officers and noncommissioned officers of the guard. No other persons are authorized to give orders to soldiers on guard duty. You should pass instructions and special information to your relief when appropriate.

Example

You are a guard on duty at an ammunition dump and discover a hole in the fence, which you report to the commander of the relief. You also pass the information on to your relief so that special attention can be paid to that part of the fence until the hole is repaired.

General Order Number 2 also requires you to perform your duties in a military manner, to be courteous to all, and to speak to no one, except in the line of duty. You must maintain an erect and soldierly bearing, carrying your weapon as instructed by the commanding officer or commander of the guard. You must salute individuals according to Army regulations. The special orders will tell you whether and when to challenge.

General Order Number 3 requires you to report all special order violations and emergencies. In case of a fire on or near your post, you should call, "*Fire, post number _____.*" You should alert the occupants if the fire is in an occupied building, and should give the alarm or make sure one is given. If possible, extinguish the fire. Help direct fire-fighting apparatus to the fire. If a disturbance occurs that requires assistance, call, "*The guard, post number _____.*" If the danger is great, fire your weapon into the air three times in rapid succession.

When you, as a guard, are asked "*What are your orders?*" by an inspecting officer, the proper answer is: "*Sir/Ma'am, my orders are of two classes: general and special. My general orders are, Number 1: I will guard everything within the limits . . . ,*" continuing until stopped by the officer or until you recite all the general orders. You

should be able to answer any questions concerning the special orders for your post.

Uniform, Arms, and Equipment. The commanding officer prescribes uniform, arms, and equipment for guard mounts. If armed, you must have completed training with the weapon to be used on guard duty.

The sergeant of the guard will organize the soldiers making up the guard into a formation, using commands and movements described in FM 22-5. The commander of the guard then prepares the guards for inspection. The officer of the day inspects the guards and orders those found unsatisfactory to fall out to the rear of the formation and await further instructions. The guards then move to the guardhouse, and the commander of the first relief prepares the relief to be posted. At the appropriate time, the old guard will be relieved by the new guard. The changing of the guard is accomplished through a ceremony conducted by the two commanders.

Exterior Guard

Exterior guards are not as formal and restricted as interior guards. Examples of exterior guards are lookouts, listening posts, outposts, certain patrols, and other guards in combat zones and field training, and guards outside the limits of a military installation. Exterior guards perform their duties according to special orders and instructions.

Your drill sergeant will use the following evaluation guides to test your knowledge of guard duty:

Evaluation Guide

Recite the General Orders

Performance Measures

1. General Order Number 1. The soldier successfully recites, "*I will guard everything within the limits of my post and quit my post only when properly relieved.*"
2. General Order Number 2. Successfully recite, "*I will obey my special orders and perform all my duties in a military manner.*"
3. General Order Number 3. Successfully recite, "*I will report violations of my special orders, emergencies, and anything not covered in my instructions to the commander of the relief.*"

Evaluation Guide

React to an Inspecting Officer

Performance Measures

The soldier—

1. Stops walking and assumes position of attention; when the inspecting officer approaches, renders a proper hand salute.
2. Executes order arms when salute is returned, and remains at attention.

Note: Inspecting officer will command, "At ease."
Inspecting officer should ask questions pertaining to the general orders. These questions will not be scored. When finished with inspection, the inspecting officer will say, "Carry on."

3. Assumes position of attention and renders a proper hand salute, holding it until it is returned.
4. Resumes walking post.

Evaluation Guide
Challenge Unknown Persons (Night) and Summon
Commander of Relief

Performance Measures

The soldier—

1. Upon seeing or hearing an unknown person, comes to port arms.
2. Commands, "Halt." (Person halts.)
3. Calls out, "Who is/goes there?" (Unknown person says, "Civilian employee.")
4. States, "Advance to be recognized."
5. Commands, "Halt," when the person can be seen but not closer than 2 to 3 meters away.
6. Says, "State your business." (Unknown person says, "I came to pick up supplies.")

7. Requires unknown person to place identification on ground and move back six steps.
8. Checks identification (ID) while keeping person under observation. (ID and authorization do not match.)
9. Moves to phone and calls commander of the relief while keeping person under observation.
10. Releases person to commander of the relief and explains that their identification and authorization do not match.

CHAPTER 5 SELECTED COMMON TASKS

Section I COMMUNICATION

This section contains the only COMMUNICATE task in STP 21-1-SMCT.

PERFORM VOICE COMMUNICATIONS 113-571-1022

CONDITIONS

Given a secure net, with no authentication required. Each member of the net receives—

1. One operational radio set, warmed up and set to the net frequency.
2. A 5-inch by 8-inch call sign information card with the following information written on it:
 - a. Duty position (S1 or S2).
 - b. A message to transmit.
 - c. Net call sign (a letter-number-letter combination) and suffixes.

E3E—Net call sign

E46—Suffix for net control station (NCS)

E39—Suffix for S1

E13—Suffix for S2

Note: Each net member must have a different suffix and message. The task may have as many net members as there are sets of equipment available.

STANDARDS

Enter a radio net, send a message, and leave a radio net. Use the proper call signs, call sign sequence, prowords, and phonetic alphabet and numerals. Perform all steps correctly.

TRAINING AND EVALUATION

Training Information Outline

1. Enter the net.

a. Determine the abbreviated call sign and answering sequence for your duty position.

b. Respond to the NCS issuing a net call (Figure 5-1).

c. Answer in alphanumeric sequence.

Note: The NCS acknowledges; the net is open.

Figure 5-1. Example response to a net call.

NCS:	Echo tree echo this is echo fow-er six—over
S2:	Echo fow-er six this is echo wun tree—over
S1:	Echo fow-er six this is echo tree niner—over
NCS:	Echo tree echo this is echo fow-er six— roger out

2. Send a message.

a. Listen to make sure the net is clear. Do not interrupt ongoing communications.

b. Call the NCS and tell the operator the priority of the message you have for their station.

Note: The NCS responds that they are ready to receive.

c. Send your message using the correct prowords. Pronounce letters and numbers correctly (Figures 5-2 through 5-7).

d. Get a receipt for the message.

Note: The NCS calls to issue you a close-down order.

3. After receiving a call from the NCS to close down the net, answer them and leave the net in alphanumeric sequence.

Note: The NCS acknowledges and the net is closed.

Figure 5-2. Alphabetical list of common prowords.

Proword	Explanation
All after	I refer to all of the message that follows . . .
All before	I refer to all of the message that precedes
Break	I now separate the text from other parts of the message.
Correction	There is an error in this transmission. Transmission will continue with the last word correctly transmitted.

Proword	Explanation
Groups	This message contains the number of groups indicated by the numeral following. . .
I say again	I am repeating transmission or part indicated.
I spell	I will spell the next word phonetically.
Message	A message that requires recording is about to follow. (Transmitted immediately after the call. This proword is not used on nets primarily employed for conveying messages. It is intended for use when messages are passed on tactical or reporting net.)
More to follow	Transmitting station had additional traffic for the receiving station.
Out	This is the end of my transmission to you and no answer is required or expected.
Over	This is the end of my transmission to you and a response is necessary. Go ahead; transmit.
Radio check	What is my signal strength and readability, that is, how do you hear me?

Proword	Explanation
Roger	I have received your last transmission satisfactorily, loud and clear.
Say again	Repeat all of your last transmission. (Followed by identification data means "Repeat [portion indicated].")
This is	This transmission is from the station whose designator immediately follows.
Time	That which immediately follows is the time or date-time group of the message.
Wait	I must pause for a few seconds.
Wait-out	I must pause for longer than a few seconds.
Wilco	I have received your transmission, understand it, and will comply. (To be used only by the addressee. Since the meaning of ROGER is included in that of WILCO, the two prowords are never used together.)
Word after	I refer to the word of the message that follows . . .
Word before	I refer to the word of the message that precedes . . .

Figure 5-3. Phonetic alphabet.

A Alpha (al fah)	B Bravo (brah voh)	C Charlie (char lee)	D Delta (dell tah)
E Echo (eck oh)	F Foxtrot (foks trot)	G Golf (golf)	H Hotel (hoh tell)
I India (indee ah)	J Juliet (jewlee ett)	K Kilo (key loh)	L Lima (lee mah)
M Mike (mike)	N November (no vem ber)	O Oscar (oss cah)	P Papa (pah pah)
Q Quebec (keh beck)	R Romeo (row me oh)	S Sierra (see air rah)	T Tango (tang go)
U Uniform (you nee form)	V Victor (vik tah)	W Whiskey (wiss key)	X Xray (ecks ray)
Y Yankee (yang key)	Z Zulu (zoo loo)	1 One (wun)	2 Two (too)
3 Three (tree)	4 Four (fow er)	5 Five (fife)	6 Six (six)
7 Seven (seven)	8 Eight (ait)	9 Nine (niner)	0 Zero (ze ro)

Figure 5-4. Alphanumeric pronunciation.

Numeral	Spoken as
44	Fow-er fow-er
90	Nin-er ze-ro
136	Wun tree six
500	Fife ze-ro ze-ro
1200	Wun too ze-ro ze-ro
1478	Wun fow-er sev-en ait
7000	Sev-en tou-sand
16000	Wun six tou-sand
812681	Ait wun too six ait wun

Figure 5-5. Sample message.

ROUTINE
TIME 0102053 JAN 94
FROM E39 TO E46
BREAK
UNCLASSIFIED
AT 1800Z PROCEED TO HONG KONG ARRIVE 16 MAY
LOAD 1000 TROOPS FOR RETURN TO NINGPO
OVER

Figure 5-6. Example receipt of message by S1.

S1: Echo fow-er six this is echo tree niner—routine over.

NCS: Echo tree niner this is echo fow-er six—roger over.

S1: Echo fow-er six this is echo tree niner—routine—time zero wun zero too zero fife tree january niner fow-er—from echo tree niner—to echo fow-er six—break—unclassified—at wun ait hundred zulu proceed to hong kong arrive wun six may load wun thousand troops for return to ningpo over.

Figure 5-7. Example closing down of the net.

NCS: Echo tree echo this is echo fow-er six—close down over.

S2: Echo fow-er six this is echo wun tree—wilco over.

S1: Echo fow-er six this is echo tree niner—wilco over.

NCS: Echo tree echo this is echo fow-er six—roger out.

Evaluation Guide:

Perform Voice Communications

Performance Measures

1. Enter the net in alphanumeric sequence.
2. Send a message of 15 to 25 words using the correct prowords and pronouncing words and numbers correctly (phonetically).
3. Leave the net in alphanumeric sequence.

Section II NAVIGATION

This section contains four NAVIGATE tasks from STP 21-1-SMCT.

IDENTIFY TERRAIN FEATURES ON A MAP 071-329-1001

CONDITIONS

Given a standard 1:50,000-scale military map.

STANDARDS

Identify the five major and three minor terrain features on the map.

TRAINING AND EVALUATION

Training Information Outline

1. Identify major terrain features.

a. Terrain features are identified in the same manner on all maps, regardless of the contour interval, but you must realize that a hill in the Rocky Mountains will be much bigger than one in south Florida. You must be able to recognize all the terrain features to locate a point on the ground or to navigate from one point to another.

b. Terrain features can be learned using the fist or hand to show what each would look like on the ground (Figures 5-8 and 5-9).

Figure 5-8. Using the fist to explain terrain features.

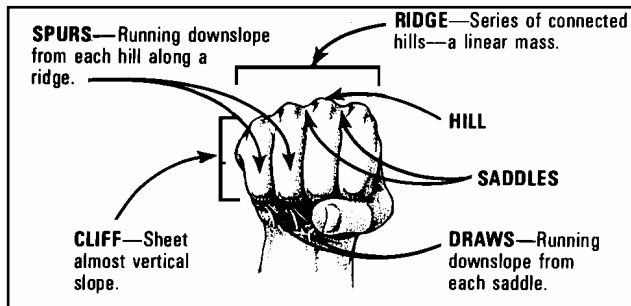
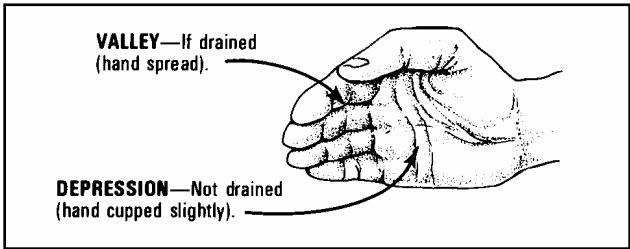

Figure 5-9. Using the hand to explain terrain features.



c. The five major terrain features on a map are—

(1) Hill—a point or small area of high ground. When you are on a hilltop, the ground slopes down in all directions (Figure 5-10).

Figure 5-10. A hill.

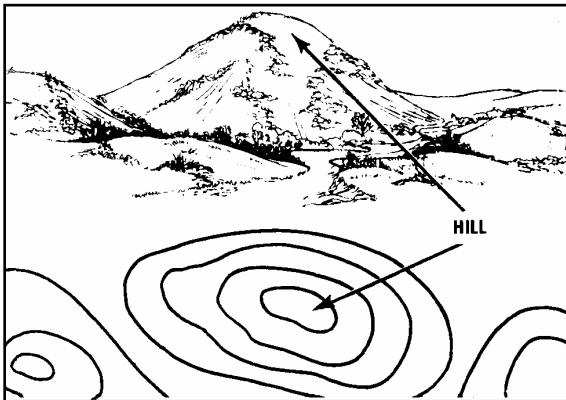

(2) Ridge—a line of high ground with height variations along its crest. The ridge is not simply a line of hills; all points of the ridge crest are higher than the ground on both sides of the ridge (Figure 5-11).

Figure 5-11. A ridge.

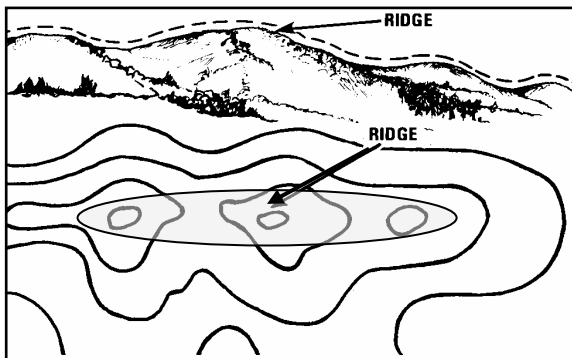

(3) Valley—reasonably level ground bordered on the sides by higher ground. A valley may or may not contain a stream course. A valley generally has maneuver room within its confines. Contour lines indicating a valley are U-shaped and tend to parallel a stream before crossing it. The course of the contour line crossing the stream always points upstream (Figure 5-12).

Figure 5-12. A valley.

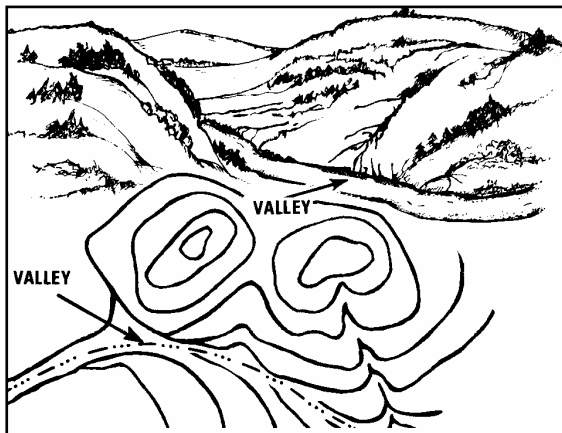
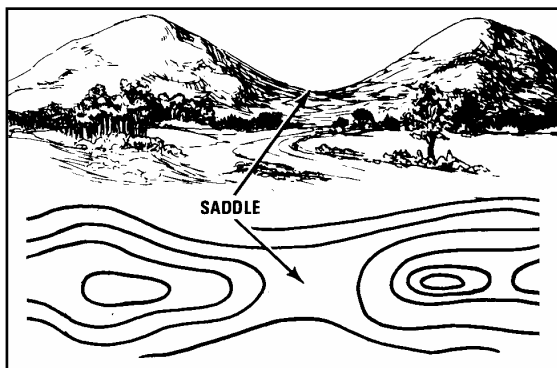

Figure 5-13. Saddle.



(4) Saddle—a dip or low point along the crest of a ridge. A saddle is not necessarily the lower ground between two hilltops; it may be a break along an otherwise level ridge crest (Figure 5-13).

(5) Depression—a low point or hole in the ground, surrounded on all sides by higher ground (Figure 5-14).

Figure 5-14. A depression.

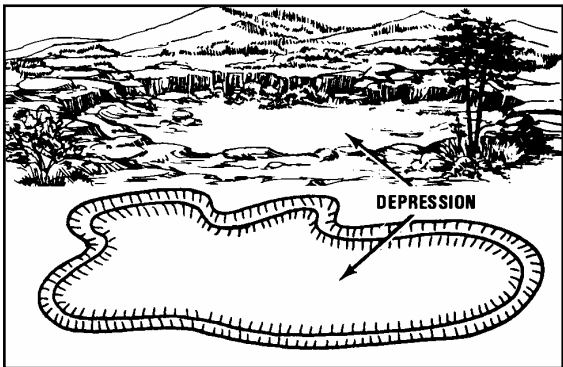

2. Identify minor terrain features. Although these features are not as important as the major terrain features, navigators can plan routes more successfully if they can identify *all* the terrain features their routes will cross over.

a. Draw—similar to a valley, except that it normally is a less developed stream course in which there is generally no level ground and, therefore, little or no maneuver room (Figure 5-15). The ground slopes upward on each side and toward the head of the draw.

Figure 5-15. A draw.

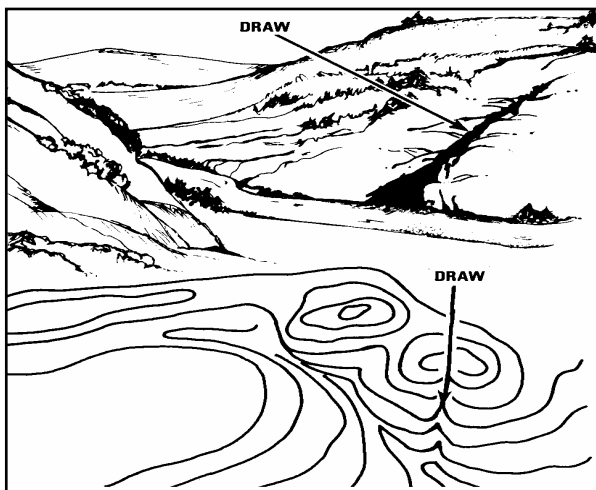

Draws are caused by flash floods and can be found on flat terrain but are more often found along the sides of ridges. Contour lines indicating a draw are shaped like a "V" with the point of the "V" toward the head of the draw (high ground).

b. Spur—a usually short, continuously sloping line of higher ground, normally jutting out from the side of a ridge. A spur is often formed by two thoroughly parallel streams cutting draws down the side of a ridge (Figure 5-16).

c. Cliff—a vertical or near-vertical slope. A cliff may be shown on a map by contour lines being .

Figure 5-16. A spur.

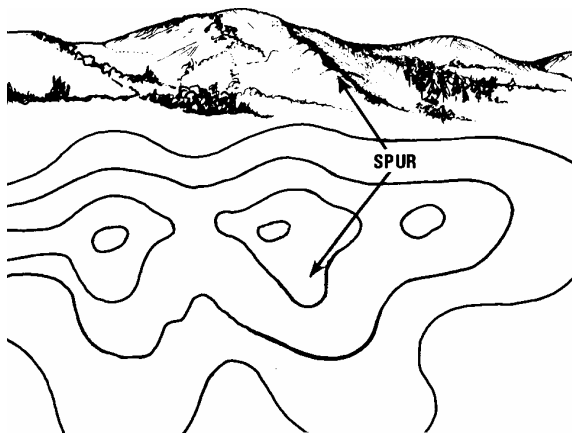

close together, touching, or by a ticked "carrying" contour line. The ticks always point toward lower ground (Figure 5-17).

Figure 5-17. A cliff.

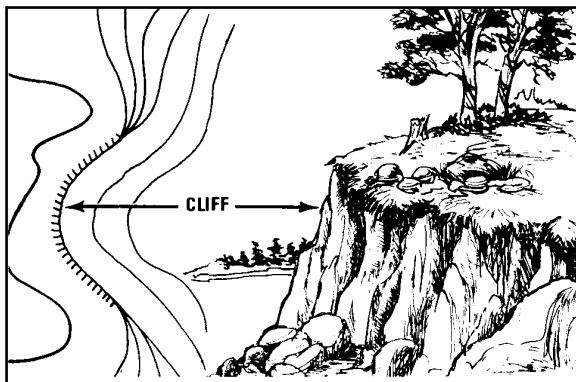

Evaluation Guide:

Identify Terrain Features on a Map

Performance Measures

1. Identify the five major terrain features on a map
2. Identify the three minor terrain features on a map

DETERMINE THE GRID COORDINATES OF A POINT ON A MILITARY MAP 071-329-1002

CONDITIONS

Given a standard 1:50,000-scale military map, a 1:50,000 grid coordinate scale, pencil, paper, and a point on the map for which coordinates must be determined.

STANDARDS

Determine the six-digit grid coordinates for the point on the map with a 100-meter tolerance (grid coordinates must contain the correct two-letter 100,000-meter-square identifier).

TRAINING AND EVALUATION

Training Information Outline

Notes: 1. To keep from getting lost, a soldier must know how to find out where he is. A combat area has no street addresses, but a military map can help you identify a location

accurately. The map has vertical lines (top to bottom) and horizontal lines (left to right). These lines form small squares 1,000 meters on each side called grid squares.

2. The lines that form grid squares are numbered along the outside edge of the map picture. No two grid squares have the same number.

3. The precision of a point location is shown by the number of digits in the coordinates: the more digits, the more precise the location.

1996—a 1,000-meter grid square.

192961—to the nearest 100 meters.

19269614—to the nearest 10 meters.

1. Look at Figure 5-18. Your address is grid square 1181. How do you know this? Start from the left and read right until you come to 11, the first half of your address. Then read up to 81, the other half. Your address is somewhere in grid square 1181 (A, Figure 5-18).

2. Grid square 1181 gives your general neighborhood, but there is a lot of ground inside that grid square. To make your address more accurate, just add another number to the first half and another number to the second half—so your address has six numbers instead of four.

a. To get those extra numbers, pretend that each grid square has ten lines inside it running north and south, and another 10 running east and west. This makes 100 smaller squares. You can estimate where these imaginary lines are.

b. Suppose you are halfway between grid line 11 and grid line 12. Then the next number is 5 and the first half of your address is 115. Now suppose you are also $\frac{3}{10}$ of the way between grid line 81 and grid line 82. Then the second half of your address is 813. (If you were exactly on line 81, the second part would be 810). Your address is 115813 (B, Figure 5-18).

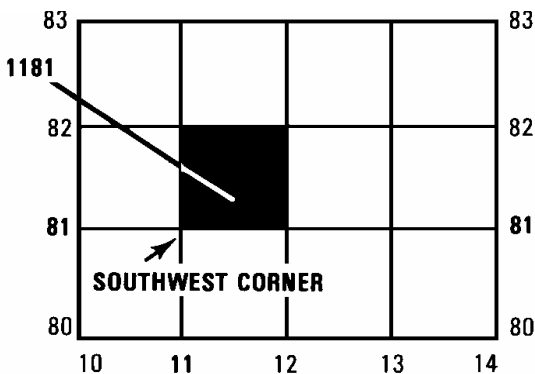

NOTE: always begin your reading from the southwest corner.

Figure 5-18. Determining a six-digit grid coordinate.

3. The most accurate way to determine the coordinates of a point on a map is to use a coordinate scale. You do not have to use imaginary lines; you can find the exact coordinates using a Coordinate Scale and Protractor (GTA 5-2-12) (Figure 5-19) or a Plotting Scale (Figure 5-20). Each device has two coordinating scales, 1:25,000 meters and 1:50,000 meters. Make sure you use the correct scale.

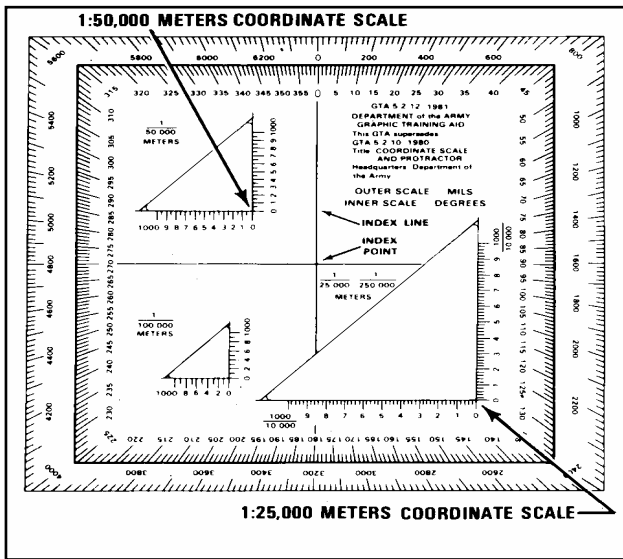

Figure 5-19. Coordinate scale and protractor.

- a. First, locate the grid square in which the point (for example, Point A, Figure 5-21, page 5-24) is located (the point should already be plotted on the map).
- b. The number of the vertical grid line on the left (west) side of the grid square is the first and second digits of the coordinates.

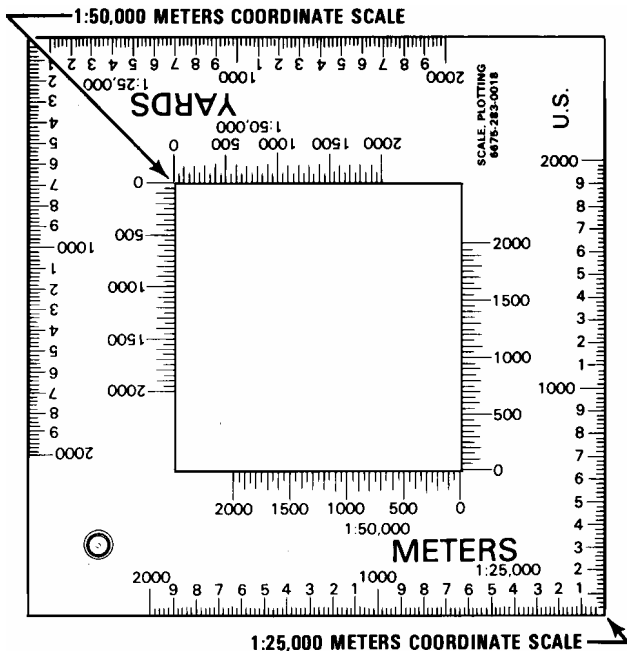

Figure 5-20. Plotting scale.

c. The number of the horizontal grid line on the bottom (south) side of the grid square is the fourth and fifth digits of the coordinates.

d. To determine the third and sixth digits of the coordinates, place the coordinate scale on the bottom horizontal grid line of the grid square containing Point A.

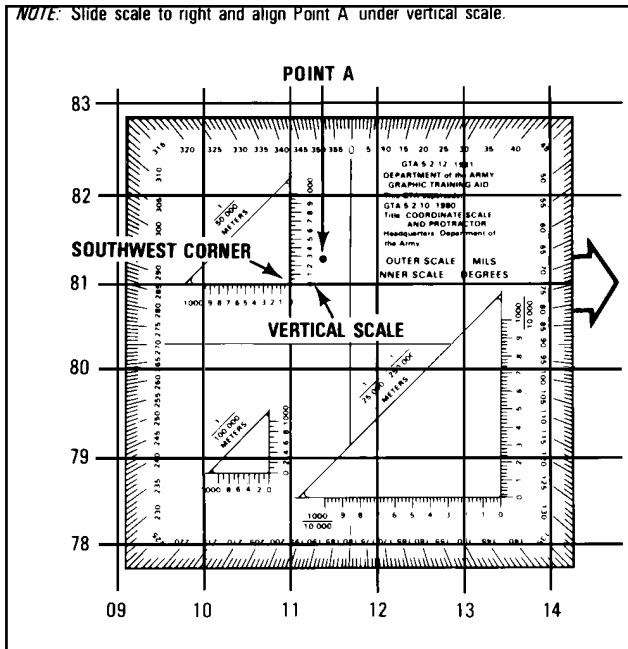

Figure 5-21. Placement of coordinate scale.

e. Check to see that the zeros of the coordinate scale are in the lower left-hand (southwest) corner of the map grid square (Figure 5-21).

f. Slide the scale to the right, keeping the bottom of the scale on the bottom grid line until Point A is under the vertical (right-hand) scale (Figures 5-22 and 5-23). On the bottom scale, the 100-meter mark nearest the vertical grid line provides the third digit, 5. On the vertical scale, the

g. To determine the correct two-letter 100,000-meter-square identifier, look at the grid reference box in the margin of the map (Figure 5-24).

h. Place the 100,000-meter-square identifier in front of the coordinate, GL 11508133.



<p>SAMPLE 1,000-METER GRID SQUARE</p> 	<p>100-METER REFERENCE</p> <ol style="list-style-type: none"> 1. READ LARGE NUMBERS LABELING THE VERTICAL GRID LINE LEFT OF POINT AND ESTIMATE TENTHS (100 METERS) FROM GRID LINE TO POINT. 2. READ LARGE NUMBERS LABELING THE HORIZONTAL GRID LINE BELOW POINT AND ESTIMATE TENTHS (100 METERS) FROM GRID LINE TO POINT. <p>EXAMPLE: 123456</p>
<p>100,000-METER SQUARE IDENTIFICATION</p> 	<p>WHEN REPORTING ACROSS A 100,000-METER LINE, PREFIX THE 100,000-METER SQUARE IDENTIFICATION IN WHICH THE POINT LIES.</p> <p>EXAMPLE: FL123456</p>
<p>GRID ZONE DESIGNATION</p> <p>16S</p>	<p>WHEN REPORTING OUTSIDE THE GRID ZONE DESIGNATION AREA, PREFIX THE GRID ZONE DESIGNATION.</p> <p>EXAMPLE: 16SFL123456</p>

Figure 5-24. Grid reference box.

Evaluation Guide:

Determine the Grid Coordinates of a Point on a Military Map

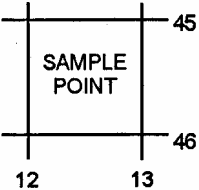
Performance Measures

1. Write down the two-letter 100,000-meter-square identifier and the six-digit grid coordinates for the designated point with a 100-meter tolerance.
2. Record the grid coordinates with the correct two-letter 100,000-meter-square identifier.

**DETERMINE A MAGNETIC AZIMUTH USING
A LENSATIC COMPASS
071-329-1003**

CONDITIONS

Given a compass and a designated point on the ground.

STANDARDS

Determine the correct magnetic azimuth to the designated point within 3 degrees using the compass-to-cheek method, or within 10 degrees using the center-hold method.

TRAINING AND EVALUATION

Training Information Outline

1. Read your compass (Figures 5-25 and 5-26).

a. The floating dial is used to determine the direction in which you are pointing your compass.

b. The outer, "black" ring of numbers and tick marks is used for finding direction in mils.

Figure 5-25. Lensatic compass.

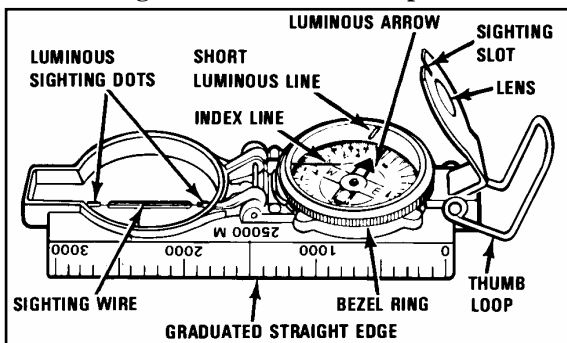
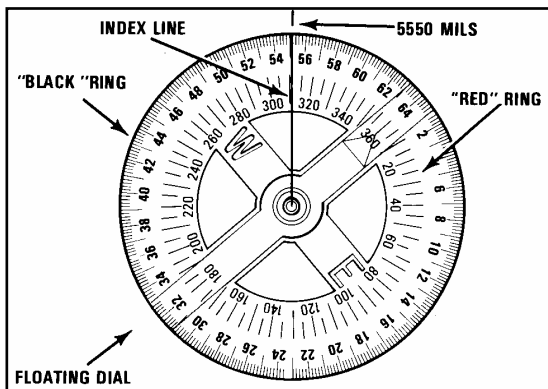

Figure 5-26. Lensatic compass floating dial.



c. The inner, "red" ring of numbers and tick marks is used for finding direction in degrees.

(1) There are 360 degrees or 6,400 mils in a circle. These are marked with a tick mark every 5 degrees and 20 mils. However, not every tick mark is numbered. You will have to determine the number for these lines using the numbers that are shown.

(2) To read direction, point the compass in the direction you want to go or want to determine.

(3) Look beneath the index line on the outer glass cover and estimate to the nearest degree or 10 mils the position of the index line over the (red or black) scale.

(4) Be careful to hold the compass still so that the dial remains stationary while you are reading the scale.

(5) In Figure 5-26, the readings are 312 degrees (red scale) and 5,500 mils (black scale).

(6) If you understand these readings and can apply either of the holding and sighting techniques of shooting an azimuth, you will be proficient in performing this task.

2. Shoot an azimuth.

a. Use your compass to determine or follow an azimuth. The arrow on the compass points toward magnetic north. The arrow is also attracted by any mass of metal—a truck, your rifle, your helmet, and even electrical power lines. Thus, be sure you use your compass away from metal objects so it will not give a wrong reading.

b. The lensatic compass must always be held level and firm when sighting on an object and reading an azimuth.

c. There are two methods of holding the lensatic compass and sighting.

(1) Compass-to-cheek method (Figure 5-27). To use this method—

(a) Open the cover to a 90-degree angle to the base. Position the eyepiece at a 45-degree angle to the base.

(b) Place your thumb through the thumb loop, form a steady base with your third and fourth fingers, and extend your index finger along the side of the compass base.

(c) Place the hand holding the compass into the palm of the other hand.

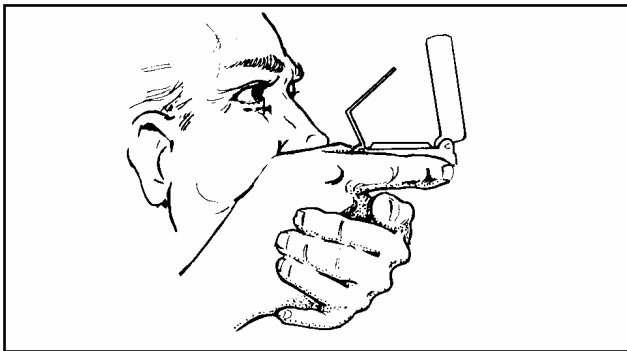

Figure 5-27. Compass-to-cheek method.

(d) Bring both hands up to the face and position the thumb that is through the thumb loop against the cheekbone.

(e) Look through the lens of the eyepiece. If the dial is not in focus, move the eyepiece up or down until the dial is in focus.

(f) Align the sighting slot of the eyepiece with the sighting wire in the cover on the point to which the azimuth is being determined. Look through the lens of the eyepiece and read the azimuth under the index line.

(2) Center-hold method (Figure 5-28). Use this method *only* when a precise direction is not required:

(a) Open the compass so that the cover forms a straight edge with the base. The lens of the compass is moved out of the way.

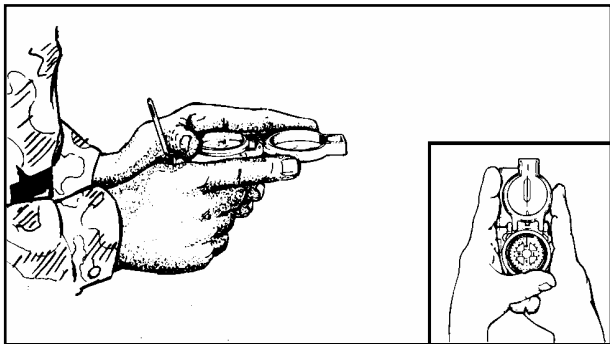

Figure 5-28. Center-hold method.

(b) Place your thumb through the thumb loop, form a steady base with your third and fourth fingers, and extend your index finger along the side of the compass.

(c) Place the thumb of the other hand between the eyepiece and the lens, extend the index finger along the remaining side of the compass, wrap the remaining fingers around the fingers of the other hand, and pull your elbows firmly into your sides. This will place the compass between your chin and your belt.

(d) To measure an azimuth, turn your entire body toward the object and point the compass cover directly at the object. Look down and read the azimuth from beneath the fixed black index line. This method can be used at night.

(e) To keep from going in circles when you are land navigating, stop occasionally to check the azimuth along which you are moving. Also, you can move from object to object along your path by shooting an azimuth to each object and then moving to that object. Repeating this process while you navigate should keep you straight.

Evaluation Guide:

Determine a Magnetic Azimuth

Performance Measures

1. Determine a magnetic Azimuth using a lensatic compass.
2. Use the compass-to-cheek method to within three degrees of a designated point.

3. Use the center-hold method within 10 degrees to a designated point.

MEASURE DISTANCE ON A MAP

071-329-1008

CONDITIONS

Given a standard 1:50,000 military map, a strip of paper or a straightedge, and a pencil.

STANDARDS

1. Determine the straight-line distance, in meters, between two points with no more than 5 percent error.
2. Determine the road (curved-line) distance, in meters, between two points with no more than 10 percent error.

TRAINING AND EVALUATION

Training Information Outline

Note: Soldiers can use their maps to measure the distance between two places. The maps are drawn to scale. This means that a certain distance on a map equals a certain distance on the earth. The scale is printed at the bottom and top of each map (Scale 1:50,000). This means that 1 inch on the map equals 50,000 inches on the ground. To change map distance to miles, meters, or yards, use the bar scales at the bottom of the map (Figure 5-29).

Figure 5-29. Bar scales.

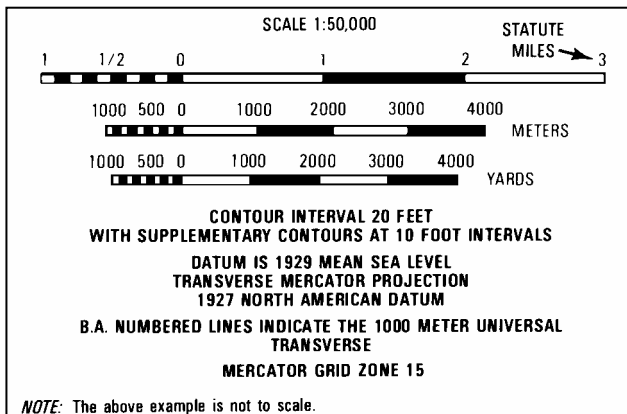
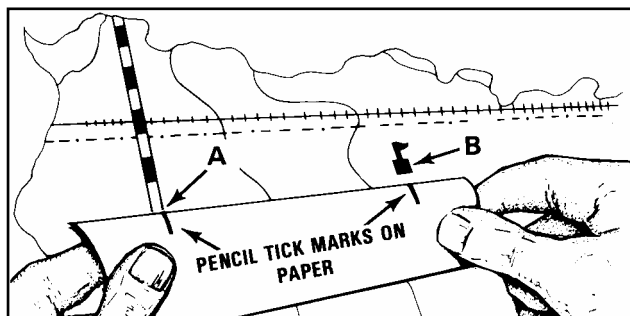

Figure 5-30. Measurement of distance.



a. Take a ruler or the edge of a piece of paper and mark on it the straight-line distance between your two points (Figure 5-30).

b. Then, put the ruler or the paper just under one of the bar scales and read the ground distance in miles, meters, or yards. The bar scale in Figure 5-31 shows a ground distance of 1,500 meters.

Figure 5-31. Determination of distance.

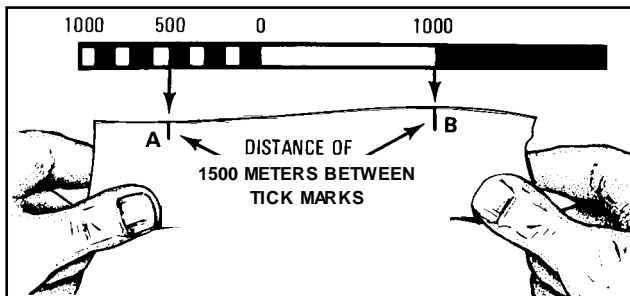

c. Suppose you want to find the distance between A and B around a curve in a road. Take a strip of paper, make a small tick mark on it, and line up the tick mark with point A. Align the paper with the road edge until you come to the curve, make another mark on the paper and on the map, and then pivot the paper so that it continues to follow the road edge. Keep repeating this until you get to B. Always follow the road edge with your paper. Make a mark on your paper where it hits B, and then go to the bar scales to get the distance (Figure 5-32).

2. Normally, you will be required to measure distance in meters, and you may receive a problem that goes off the bar scale. The meter bar scale allows you to measure distances up to 5,000 meters. If you have to measure distances greater than 5,000 meters, follow this procedure:

a. Place your starting point on the paper under the zero on the bar scale. Measure off 4,000 meters and place a new tick mark at the point on your paper.

Figure 5-32. Map distance—1,800 meters.

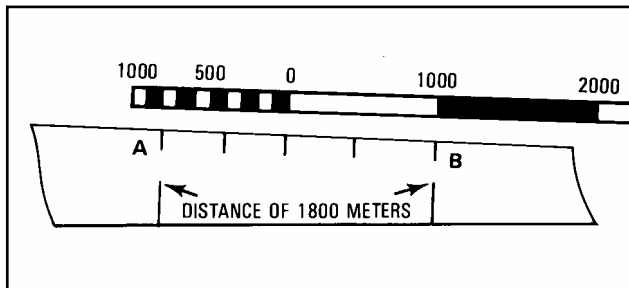

b. Place this second tick mark also under the zero on the bar scale and determine if the distance on the paper now falls within the bar scale. If it does, add this value to 4,000 to give a total distance. If it does not, repeat the last step (a) until the distance on the paper falls within the bar scale. Remember to add this last value to the total number of meters you have already measured.

Evaluation Guide:

Measure Distance on a Map

Performance Measures

1. Measure the straight-line distance on the map using the straightedge.
2. Place the paper under the meter bar scale.
3. Determine the distance with no more than 5 percent error.

4. Measure the curved-line distance using the strip of paper.
5. Place the paper under the meter bar scale.
6. Determine the distance with no more than 10 percent error.

Section III WEAPONS

MAINTAIN AN M16A2 RIFLE 071-311-2025

CONDITIONS

Given an M16A2 rifle, magazine, 5.56-mm ammunition, small arms maintenance equipment case and lubricating instructions. You have the following cleaning materials: Swabs, pipe cleaner, and cleaner lubricant preservative (CLP). You also have lubricating oil, semifluid, weapons; lubricating oil, Arctic, weapons; and rifle bore cleaner.

STANDARDS

Clean, inspect and lubricate the rifle and magazine so that they function correctly. Clean and inspect the ammunition. Turn in any unserviceable ammunition.

TRAINING AND EVALUATION

Training Information Outline

1. Clear the rifle.

- a. Remove the magazine from the rifle, if there is one present.
- b. Cock the rifle.
- c. Turn the selector to SAFE (A, Figure 5-33).

NOTE: The selector cannot be turned to SAFE unless the rifle is cocked.

- d. Lock the bolt open (B, Figure 5-33).



Figure 5-33. Clearing an M16A2 rifle.

- e. Pull the charging handle rearward.
- f. Press the bottom of the bolt catch.
- g. Allow the bolt to move forward until it engages the bolt catch.

- h. Return the charging handle to the forward position.
- i. Ensure the selector is on SAFE.
- j. Check the receiver and chamber to ensure they do not contain ammunition (C, Figure 5-34).
- k. Allow the bolt to go forward by pressing the upper portion of the bolt catch (D, Figure 5-34).

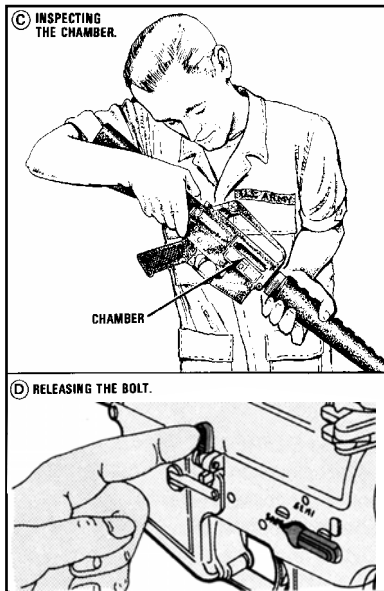

Figure 5-34.
Clearing an M16A2
rifle (continued)

2. Disassemble the rifle.

- a. Verify the rifle is clear.

- b. Remove the sling.

- c. Remove the handguards only if you can see dirt or corrosion through the vent holes (Figure 5-35).

Handguards on the

M16A2 are interchangeable because they are identical.

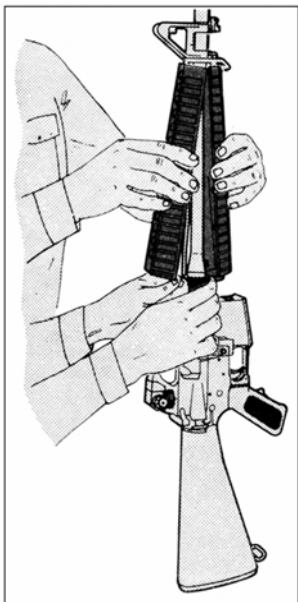

Figure 5-35. Removing the handguards.

1) Push the takedown pin as far as it will go and pivot the upper receiver from the lower receiver (B, Figure 5-36).

2) Push the receiver pivot pin (C, Figure 5-36).

3) Separate the upper and lower receivers (D, Figure 5-36).

d. Pull back the charging handle (E, Figure 5-36).

e. Remove the bolt carrier and bolt (F, Figure 5-36).

1) Remove the charging handle (G, Figure 5-36).

2) Remove the firing pin retaining pin (H, Figure 5-36).

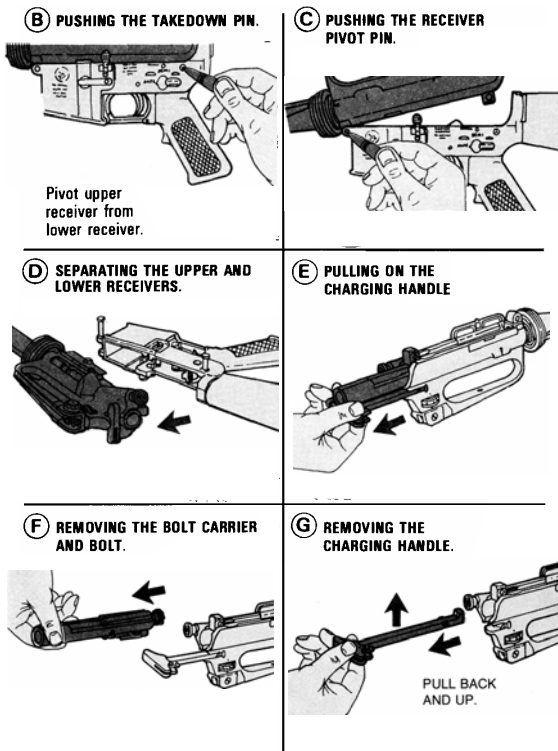

Figure 5-36. Disassembling the rifle.

3) Put the bolt assembly in the locked position by pushing in the bolt (I, Figure 5-36).

4) Remove the firing pin by allowing it to drop out of the rear of the bolt carrier into your hand (J, Figure 5-36).

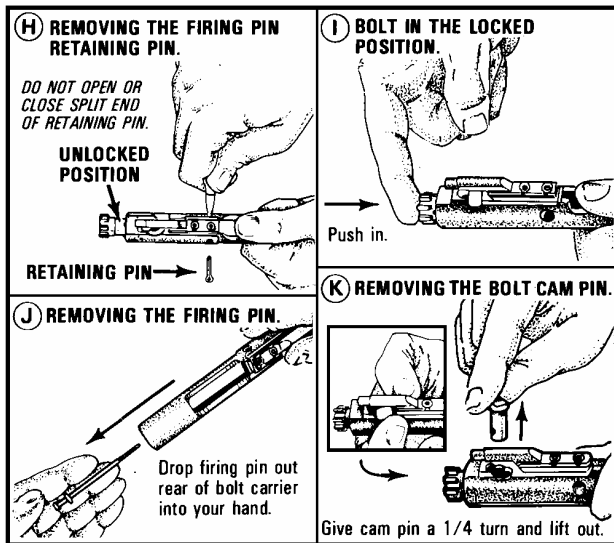

Figure 5-36. Disassembling the rifle (continued).

5) Remove the bolt cam pin by turning it one-quarter turn and lifting it out (K, Figure 5-36).

6) Pull the bolt assembly from the carrier (L, Figure 5-36).

NOTE: Perform steps o through r only when the parts are dirty or damaged.

7) Remove the extractor pin by pushing it out with the firing pin (use care not to damage the firing pin) (M, Figure 5-36).

8) Lift out the extractor and spring (N, Figure 5-36), taking care so that the spring does not separate from the extractor.

NOTE: Press the top of the extractor to check spring function.

f. Release the buffer by pressing the buffer and depressing the retainer.

g. Remove the buffer and action spring separating the buffer from the spring (O, Figure 5-36).

h. Do not disassemble the rifle further.

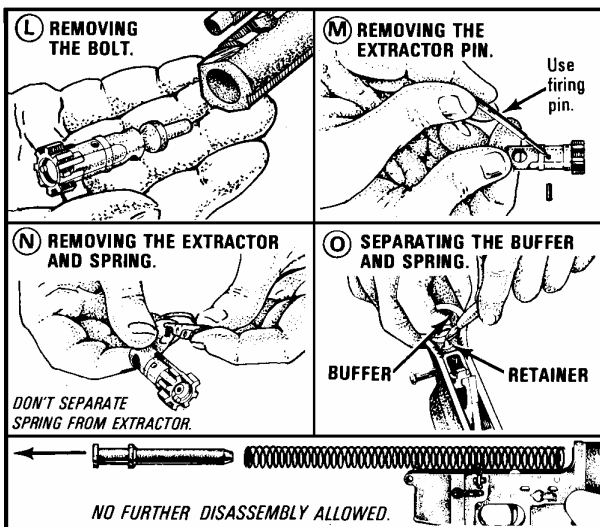
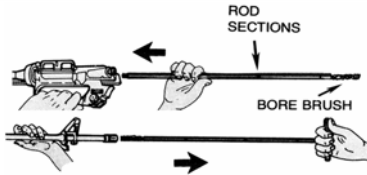

Figure 5-36. Disassembling the rifle (continued).

3. Clean the rifle by removing carbon buildup and lubricating according to lubrication instructions. Make sure you remove any excessive oil from the bore before firing.

NOTE: After firing ball or blank ammunition, clean the weapon with CLP. Under all but the coldest Arctic conditions, use only CLP to lubricate the rifle.

① START AT RECEIVER. GO THROUGH THE FLASH SUPPRESSOR.



② CLEAN BARREL LOCKING LUGS AND GAS TUBE.

Use a worn bore brush to clean outside surface of protruding gas tube (get to sides and bottom from bottom of receiver).

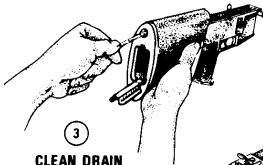
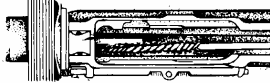

③ CLEAN DRAIN HOLE WITH PIPE CLEANER.

④ BRUSH DIRT FROM TRIGGER MECHANISM.



⑤ CLEAN BUFFER AND INSIDE LOWER RECEIVER EXTENSION.



BUFFER AND ACTION SPRING

Figure 5-37. Cleaning the Receivers.

a. Clean the upper and lower receiver group using CLP to remove powder fouling in the upper receiver (Figure 5-37).

b. Clean the bolt carrier group, wiping the following parts with swabs and other parts from the small arms maintenance equipment case (Figure 5-38).

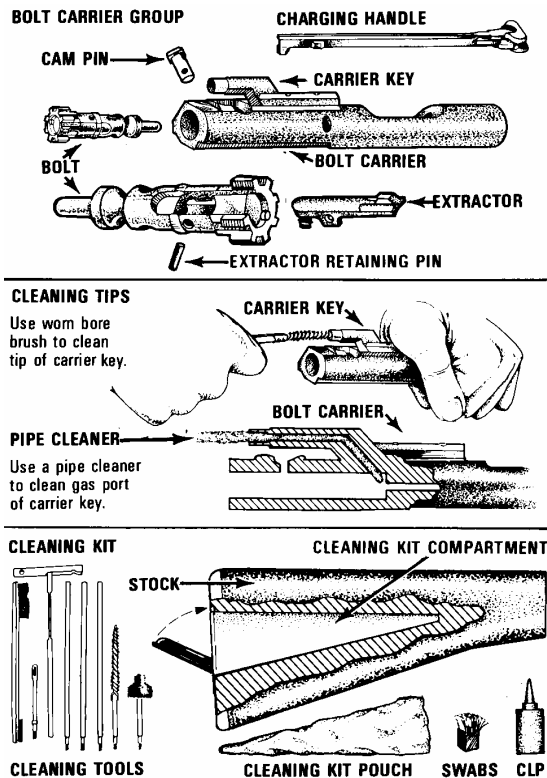

Figure 5-38. Cleaning the bolt carrier group

- 1) The outer and inner surfaces of the bolt carrier.
- 2) The carrier key.
- 3) The firing pin recess and firing pin.
- 4) The firing pin hole with a pipe cleaner.
- 5) The carbon deposits and dirt from the locking lugs.
- 6) The areas behind the bolt ring and under the lip of the extractor.

c. Clean the following rifle parts lightly lubricating with CLP (Figure 5-38).

- 1) Lugs in the barrel extension, bore, and chamber.
- 2) Bolt carrier.
- 3) Slide cam pin area.
- 4) Piston rings.
- 5) Outside the bolt body.
- 6) Inside the bolt carrier key.
- 7) Firing pin and firing pin recess.
- 8) Outside surface of the protruding gas tube with a worn bore brush.

- 9) Buffer.
 - 10) Action spring.
 - 11) Inner surfaces of the lower receiver extension.
 - 12) Inside the lower receiver.
 - 13) All other components.
4. Inspect disassembled rifle bolt assembly (Figure 5-39).
- a. Identify defective or missing components.
 - b. Report deficiencies to the armorer.

WARNING
DO NOT INTERCHANGE BOLTS BETWEEN RIFLES



Check for cracks or fractures especially in the cam pin hole area; bolts that contain pits extending into the firing pin hole need replacing.

FIRING PIN — Bent, cracked or blunted end.



CAM PIN — Cracked, chipped or missing.



FIRING PIN RETAINING PIN — Bent, busted, badly worn.



EXTRACTOR AND EXTRACTOR SPRING — Check extractor for chipped or broken edges in the area of the lip that engages the cartridge rim.



Figure 5-39. Inspecting the bolt assembly.

5. Assemble the rifle.

- a. Insert the spring and buffer (A, Figure 5-40).
- b. Insert the extractor and spring (B, Figure 5-40).
- c. Push the extractor pin in (C, Figure 5-40).

d. Slide the bolt into the carrier until the bolt cam pinhole in both the bolt carrier and the bolt are aligned (Figure D, 5-40).

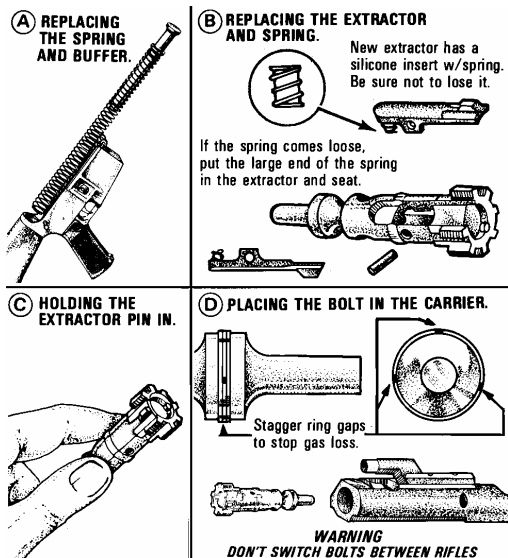

Figure 5-40. Assembling the rifle.

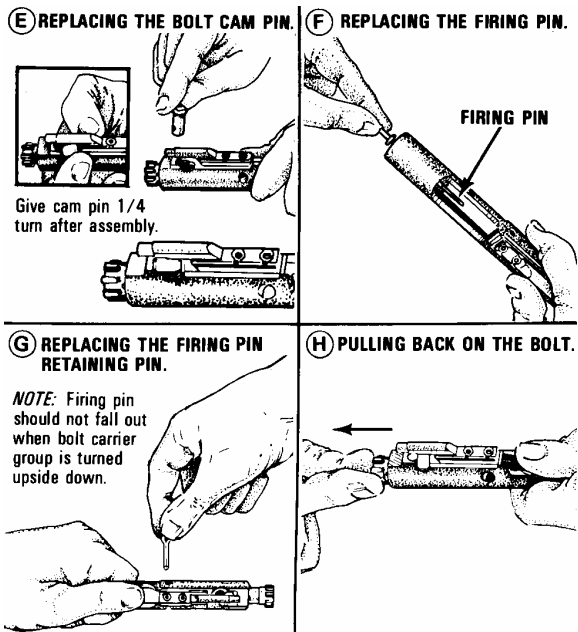

Figure 5-40. Assembling the rifle (continued).

- e. Place the bolt cam pin by putting it in the bolt carrier turning it one-quarter turn (E, Figure 5-40).
- f. Drop in the firing pin to seat it (F, Figure 5-40).
- g. Put the firing pin retaining pin in the bolt carrier to seat it (G, Figure 5-40).
- h. Pull the bolt back (H, Figure 5-40).

- i. Place the charging handle by engaging it, then pushing the charging handle part of the way in (I, Figure 5-40).
- j. Slide the bolt carrier into the upper receiver (J, Figure 5-40).
- k. Push the charging handle and bolt carrier together in the upper receiver (K, Figure 5-40).
- l. Join the upper and lower receiver (L, Figure 5-40).

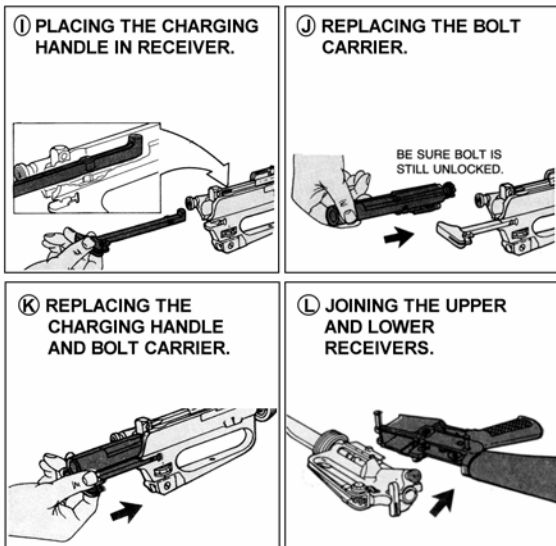

Figure 5-40. Assembling the rifle (continued).

- m. Engage the receiver pivot pin (M, Figure 5-40).
- n. Close the upper and lower receiver groups, seating the takedown pin, and ensuring the selector switch is on safe (N, Figure 5-40).
- o. Put the handguards in place (O, Figure 5-40).
- p. Replace the sling (P, Figure 5-40).

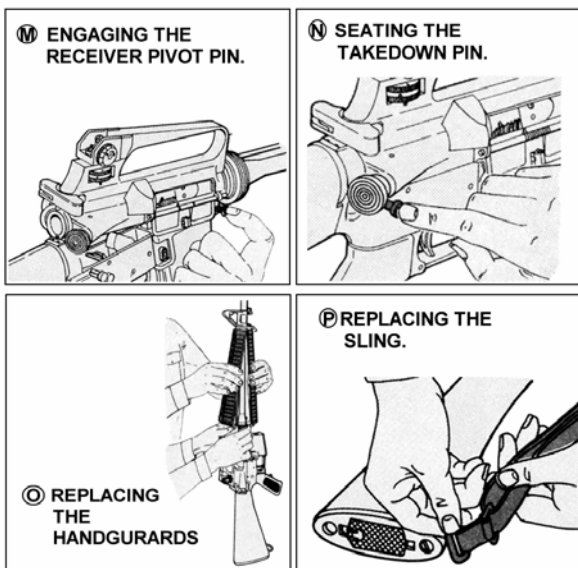

Figure 5-40. Assembling the rifle (continued).

- 6. Disassemble the magazine without removing the follower from the spring.

- a. Release the base catch (A, Figure 5-41).
- b. Remove the base (B, Figure 5-41).
- c. Remove the spring and follower by jiggling spring and follower (C, Figure 5-41).

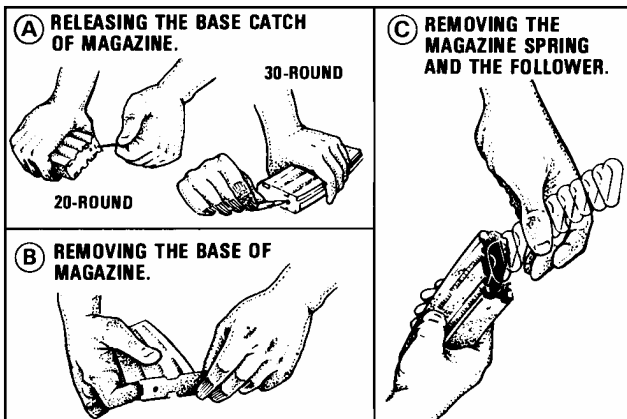

Figure 5-41. Disassembling the magazine.

7. Clean the magazine.
 - a. Wipe the dirt from the tube, spring and follower.
 - b. Lubricate the spring lightly.
8. Assemble the magazine.

a. Jiggle the spring and follower together to install them in the magazine.

b. Slide the base under all four tabs, making sure that the print is on the outside.

9. Clean the ammunition using a clean, dry cloth to wipe dirt and foreign matter from the ammunition. Do not coat with oil.

**PERFORM A FUNCTION CHECK ON AN
M16A2 RIFLE
071-311-2026**

CONDITIONS

Given an M16A2 rifle that you must confirm is operable.

STANDARDS

Perform the function check, ensuring that the rifle operates properly with the selector switch in each position.

TRAINING AND EVALUATION

Training Information Outline

1. Check an M16A2 with the selector lever in the SAFE position (Figure 5-36).

a. Pull the charging handle to the rear and release it.

b. Place the selector lever in the SAFE position.

c. Pull the trigger (the hammer should not fall).

Figure 5-36. Selector on SAFE.

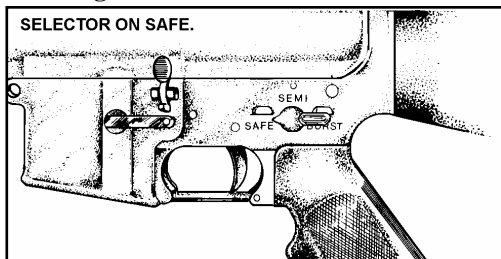

2. Check an M16A2 with the selector lever in the SEMI position (Figure 5-37).
 - a. Place the selector lever in the SEMI position.
 - b. Pull the trigger, holding it to the rear (the hammer should fall).
 - c. Continue to hold the trigger to the rear while pulling the charging handle to the rear and releasing the charging handle.

Figure 5-37. Selector on SEMI.

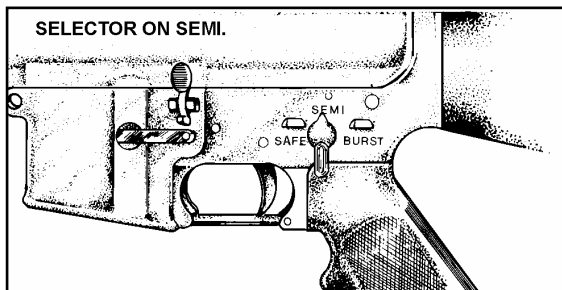

- d. Release the trigger with a slow, smooth motion until
 - e. The trigger is fully forward (the hammer should not fall).
 - f. Pull the trigger (the hammer should fall).
3. Check an M16A2 with the selector lever in the BURST position (Figure 5-38).
- a. Place the selector lever in the BURST position.
 - b. Pull the charging handle to the rear and release it.
 - c. Pull the trigger holding it to the rear (the hammer should fall).
 - d. Continue to hold the trigger to the rear while pulling the charging handle to the rear and releasing the charging handle.

Figure 5-38. Selector on burst.

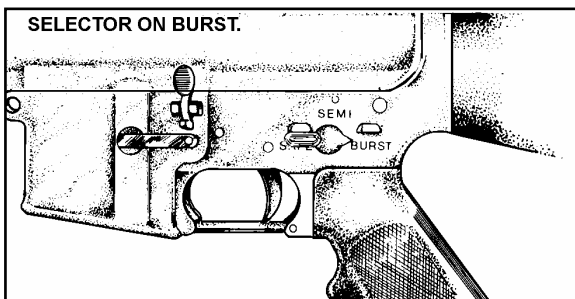

- e. Repeat step 4d twice.

- f. Release the trigger.
 - g. Pull the trigger (the hammer should fall).
4. Stop the function check any time the rifle does not function properly.
 5. Turn in the malfunctioning rifle to the unit armorer.

LOAD AN M16A2 RIFLE

071-311-2027

CONDITIONS

Given an unloaded M16A2 rifle with a magazine loaded with ammunition.

STANDARDS

Load an M16A2 rifle in both the semiautomatic and burst modes. In either case, ensure that a round is chambered and the selector is returned to the SAFE position.

TRAINING AND EVALUATION

Training Information Outline

1. Determine the mode in which the rifle will be operated by using Table 5-39.
2. Prepare the M16A2 rifle for semiautomatic fire.

A 2	OPERATING POSITION	SELECTOR	RIFLE WILL
X	Safe	SAFE	Not fire.
X	Semiautomatic	SEMI	Fire 1 round each time the trigger is pulled.
X	Burst	BURST	Fire a 3-round burst each time the trigger is pulled.

Table 5-39. M16A2 operating modes.

3. Prepare the M16A2 rifle for semiautomatic fire.
 - a. Point the rifle muzzle in a safe direction.
 - b. Cock the rifle (this also opens the bolt).
 - c. Return the charging handle to the forward position.
 - d. Place the selector lever on SAFE (A, Figure 5-40a).
 - e. Check the chamber to ensure it is clear (B, Figure 5-40a).
 - f. Insert the magazine, pushing it upward until the magazine catch engages and holds the magazine.
 - g. Tap upward on the bottom of the magazine to ensure it is seated (C, Figure 5-40a).

NOTE: The magazine may be loaded with the bolt assembly open or closed.

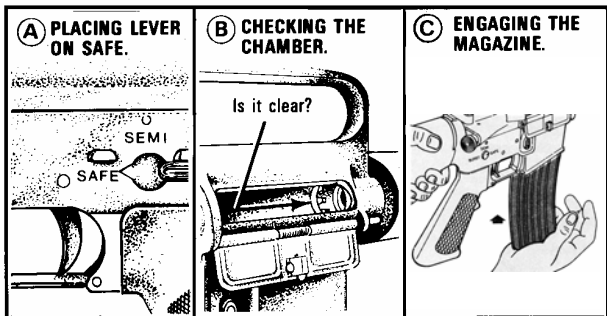

Figure 5-40a. Loading the rifle.

4. Prepare the M16A2 rifle for burst fire.
 - a. Point the rifle muzzle in a safe direction.
 - b. Cock the rifle (this also opens the bolt).
 - c. Return the charging handle to the forward position.
 - d. Place the selector lever in the BURST position (A, Figure 5-41).
 - e. Pull the trigger, holding it in the rear position.
 - f. Pull the charging handle to the rear and release it (B, Figure 5-41).
 - g. Repeat step 3f three times.
 - h. Pull the charging handle to the rear, holding it in place.

- i. Release the trigger.
- j. Push in on the bottom portion of the bolt catch, locking the bolt in the rear position (C, Figure 5-41).
- k. Slide the charging handle all the way forward.
- l. Place the selector on SAFE.

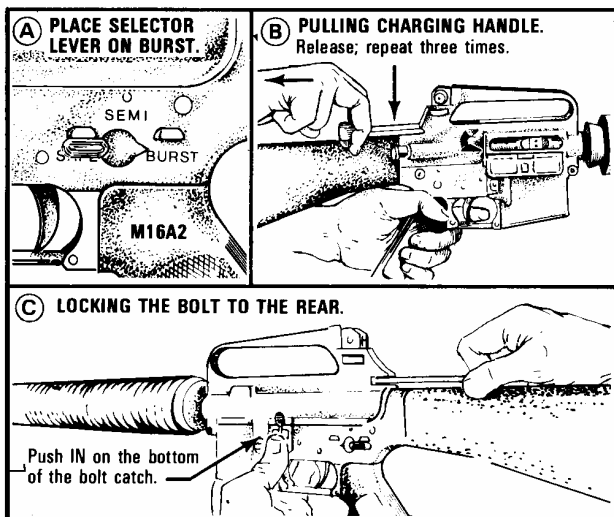

Figure 5-41. Preparing the M16A2 to fire bursts.

5. Chamber a round.
 - a. With the bolt open:

1) Depress the upper portion of the bolt catch to release the bolt (A, Figure 5-42).

2) Tap the forward assist to ensure that the bolt is fully forward and locked (B, Figure 5-42).

3) Place selector lever on SAFE, closing the ejection port cover if the rifle is not to be fired immediately.

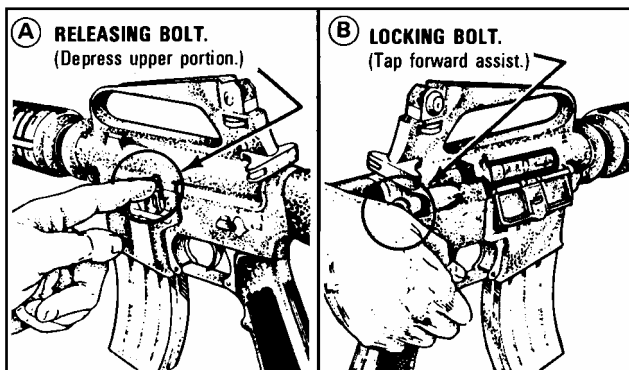

Figure 5-42. Chambering a round.

b. With the bolt closed:

1) Pull the charging handle to the rear as far as it will go.

2) Release the charging handle. Do not ride the charging handle; allow it to return on its own.

3) Tap the forward assist to ensure the bolt is fully forward and locked.

4) Place the selector lever on SAFE closing the ejection port cover if the rifle is not to be fired immediately.

UNLOAD AN M16A2 RIFLE 071-311-2028

CONDITIONS

Given a loaded M16A2 rifle from which you must remove the ammunition.

STANDARDS

Clear the rifle, removing all ammunition and securing the rifle in the SAFE mode.

TRAINING AND EVALUATION

Training Information Outline

1. Point the rifle muzzle in a safe direction.
2. Place the selector lever on SAFE.
3. Remove the magazine from the rifle.
4. Lock the bolt open.
 - a. Pull the charging handle rearward.
 - b. Press the bottom of the bolt catch.
 - c. Return the charging handle to the forward position.

5. Remove any ammunition from the receiver and chamber.
6. Press the upper portion of the bolt catch, allowing the bolt to go forward.
7. Pull the trigger to release the pressure on the firing pin spring.

**CORRECT MALFUNCTIONS OF AN
M16A2 RIFLE
071-311-2029**

CONDITIONS

Given a loaded M16A2 rifle that has a malfunction and has stopped firing.

STANDARDS

Eliminate the stoppage so that firing is resumed.

TRAINING AND EVALUATION

Training Information Outline

WARNING

If your rifle malfunctions with a live round in the chamber of a hot barrel, quickly remove the round. If you can not remove the round within 10 seconds, remove the magazine and wait 15 minutes with the rifle pointed in a safe direction. Keep your face away from the ejection port while clearing a hot chamber to avoid possible injury from a cookoff.

1. Perform immediate action.

NOTE: If your rifle malfunctions, remember S-P-O-R-T-S. This key word will help you remember these actions in sequence: Slap, Pull, Observe, Release, Tap, Shoot.

a. **S**lap upward on the magazine to make sure it is properly seated.

b. **P**ull the charging handle all the way back.

c. **O**bserve the ejection of the case or cartridge. Look into the chamber and check for obstructions.

d. **R**elease the charging handle to feed a new round in the chamber. Do not ride the charging handle.

e. **T**ap the forward assist.

f. **S**hoot. If the rifle still does not fire, inspect it to determine the cause of the stoppage or malfunction and take appropriate remedial action.

2. Perform remedial action.

NOTE: If your rifle still fails to fire after performing steps 1a through 1f, check again for a jammed cartridge case in the chamber.

a. If a cartridge case is in the chamber, tap it out with a cleaning rod.

NOTE: If your rifle still fails to fire, you may have a mechanical failure.

- b. Correct a mechanical malfunction.
- c. Clear the rifle.
- d. Disassemble the rifle.
- e. Inspect for dirty, corroded, missing, or broken parts.
- f. Clean dirty or corroded parts.
- g. Replace missing or broken parts.
- h. Assemble the rifle.
- i. Perform a function check.
- j. Load the rifle.
- k. Fire the rifle.

**PERFORM ROUTINE PREVENTIVE MAINTENANCE
CHECKS AND SERVICES ON AN M16A2 RIFLE
NTN**

CONDITIONS

Given an M16A2 rifle that has been cleared of any and all ammunition, and one empty magazine.

STANDARDS

Inspect the rifle and magazine for any conditions that could cause a weapon malfunction or some other condition that could endanger the operator.

TRAINING AND EVALUATION

Training Information Outline

1. Insert the magazine into the magazine well and ensure that it locks in place.

a. If the magazine fails to seat, examine the magazine for distortions. Replace the magazine and attempt to lock the new magazine in place.

b. If a second magazine fails to lock into place, examine the magazine well for distortions or damage. Any imperfections identified within the magazine well should be brought to the attention of the unit armorer immediately.

2. Check the magazine catch on the lower receiver.

a. Check the magazine catch for spring tension and retention of the magazine. If the magazine catch has no spring tension or does not retain the magazine, notify the unit armorer immediately.

b. Insert the magazine into the magazine well. The magazine catch should hold the magazine in place. Pressing the magazine catch should release the magazine. To adjust the magazine catch, use a cleaning rod to press in on the magazine catch button until the left side of the magazine catch sticks out beyond the receiver.

c. If the magazine catch will not retain the magazine, turn the magazine catch clockwise to tighten the tension.

d. If the magazine catch will not release the magazine, turn the magazine catch counterclockwise to loosen the tension.

e. If neither adjustment corrects the retention problem, notify the unit armorer.

3. Check the barrel for looseness. Attempt to turn the barrel in either direction using hand pressure only. Any movement of the barrel signals the need to immediately notify the unit armorer. Do not continue firing this weapon. If the weapon has been fired recently, recognize that the possibility of suffering burns from a hot barrel is high. Utilize protection for any part of the body that may come into contact with the barrel, preferably Nomex.

4. Examine the sights on the weapon. Move both the front and rear sights to make sure they can be adjusted. Return the sights to the zero setting of your rifle. If the sights are damaged, missing, or can't be adjusted, notify the unit armorer immediately.

5. Conduct a visual inspection of the rifle. If parts are missing or damaged to the point of being unserviceable, notify the unit armorer.

6. After conducting the inspections listed above, thoroughly clean and lubricate the weapon according to the guidance in the above sections. If the weapon is being

fired, clean and lubricate the weapon after approximately 200 rounds of ammunition have been fired, or at the end of the day. Report all damaged or missing parts, or other weapon malfunctions, to the unit armorer.

MARKSMANSHIP FUNDAMENTALS

The soldier must understand the four key fundamentals before he approaches the firing line. He must be able to establish a **steady position** that allows observation of the target. He must **aim** the rifle at the target by aligning the sight system, and he must fire the rifle without disturbing this alignment by improper **breathing** or during **trigger squeeze**. The skills needed to accomplish these are known as **rifle marksmanship fundamentals**. These simple procedures aid the firer in achieving target hits under many conditions when expanded with additional techniques and information. Applying these four fundamentals rapidly and consistently is called the **integrated act of firing**.

Steady Position. When the soldier approaches the firing line, he should assume a comfortable, steady firing position in order to hit targets consistently. The time and supervision each soldier has on the firing line are limited, Therefore, he must learn how to establish a steady position during dry-fire training. The firer is the best judge as to the quality of his position. If he can hold the front sight post steady through the fall of the hammer, he has a good position. The steady position elements are as follows:

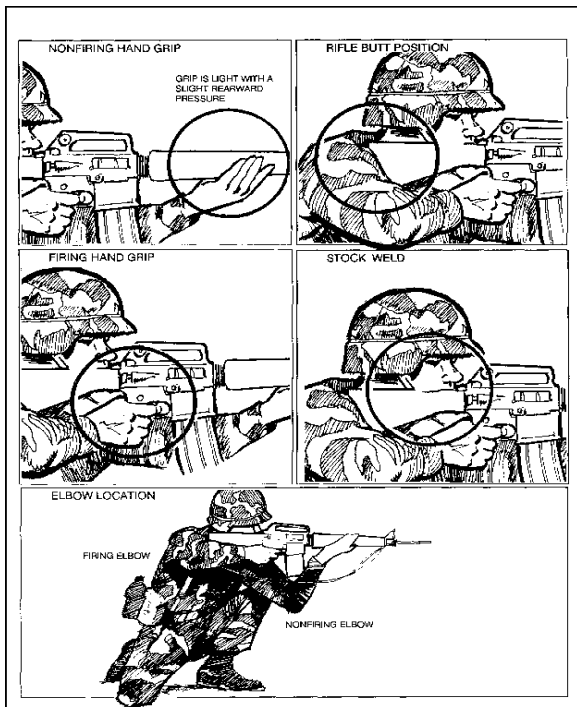

Nonfiring hand grip. The rifle handguard rests on the heel of the hand in the V formed by the thumb and fingers. The grip of the nonfiring hand is light, and slight rearward pressure is exerted.

Rifle butt position. The butt of the stock is placed in the pocket of the firing shoulder. This reduces the effect of recoil and helps ensure a steady position.

Firing hand grip. The firing hand grasps the pistol grip so that it fits the V formed by the thumb and forefinger. The forefinger is placed on the trigger so that the lay of the rifle is not disturbed when the trigger is squeezed. A slight rearward pressure is exerted by the remaining three fingers to ensure that the butt of the stock remains in the pocket of the shoulder, thus minimizing the effect of recoil.

Firing elbow placement. The location of the firing elbow is important in providing balance. The exact location, however, depends on the firing/fighting position used - for example, kneeling, prone, or standing. Placement should allow shoulders to remain level.

Nonfiring elbow. The nonfiring elbow is positioned firmly under the rifle to allow for a comfortable and stable position. When the soldier engages a wide sector of fire, moving targets, and targets at various elevations, his nonfiring elbow should remain free from support.

Stock weld. The stock weld is taught as an integral part of various positions. Two key factors emphasized are that the stock weld should provide for a natural line of sight through the center of the rear sight aperture to the front sight post and to the target. The firer's neck should be relaxed, allowing his cheek to fall naturally onto the stock. Through dry-fire training, the soldier is encouraged to practice this position until he assumes the same stock weld each time he assumes a given position. This provides consistency in aiming, which is the purpose of obtaining a correct stock weld. Proper eye relief is obtained when a soldier establishes a good stock weld. There is normally a small change in eye relief each time he assumes a different firing position. Soldiers should begin by trying to touch

his nose close to the charging handle when assuming a firing position.

Support. If artificial support (sandbags, logs, stumps) is available, it should be used to steady the position and to support the rifle. If it is not available, then the bones, not the muscles, in the firer's upper body must support the rifle.

Muscle relaxation. If support is properly used, the soldier should be able to relax most of his muscles. Using artificial support or bones in the upper body as support allows him to relax and settle into position. Using muscles to support the rifle can cause it to move.

Natural point of aim. When the soldier first assumes his firing position, he orients his rifle in the general direction of his target. Then he adjusts his body to bring the rifle and sights exactly in line with the desired aiming point. When using proper support and consistent stock weld, the soldier should have his rifle and sights aligned naturally on the target. When this correct body-rifle-target alignment is achieved, the front sight post must be held on target, using muscular support and effort. As the rifle fires, the muscles tend to relax, causing the front sight to move away from the target toward the natural point of aim. Adjusting this point to the desired point of aim eliminates this movement. When multiple target exposures are expected (or a sector of fire must be covered), the soldier should adjust his natural point of aim to the center of the expected target exposure area (or center of sector).

Aiming. Focusing on the front sight post is a vital skill the firer must acquire during practice. Having mastered the

task of holding the rifle steady, the soldier must align the rifle with the target in exactly the same way for each firing. The firer is the final judge as to where his eye is focused. The instructor/trainer emphasizes this point by having the firer focus on the target and then focus back on the front sight post. He checks the position of the firing eye to ensure it is in line with the rear sight aperture. He uses the M16 sighting device to see what the firer sees through the sights.

Rifle sight alignment. Alignment of the rifle with the target is critical. It involves placing the tip of the front sight post in the center of the rear sight aperture. (Figure 5-47). Any alignment error between the front and rear sights repeats itself for every 1/2 meter the bullet travels. For example, at the 25-meter line, any error in rifle alignment is multiplied 50 times. If the rifle is misaligned by 1/10 inch, it causes a target at 300 meters to be missed by 5 feet.

Focus of the eye. A proper firing position places the eye directly on line with the center of the rear sight. When the eye is focused on the front sight post, the natural ability of the eye to center objects in a circle and to seek the point of greatest light (center of the aperture) aid in providing correct sight alignment. For the average soldier firing at combat-type targets, the natural ability of the eye can accurately align the sights. Therefore, the firer can place the tip of the front sight post on the aiming point, but the eye must be focused on the tip of the front sight post. This causes the target to appear blurry, while the front sight post is seen clearly. Two reasons for focusing on the tip of the front sight post are:

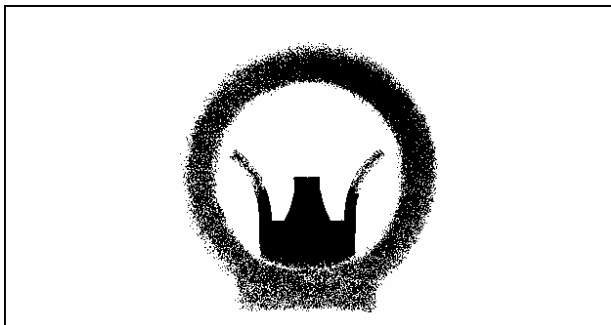

Figure 5-47. Correct Sight Picture

Only a minor aiming error should occur since the error reflects only as much as the soldier fails to determine the target center. A greater aiming error can result if the front sight post is blurry due to focusing on the target or other objects.

Focusing on the tip of the front sight post aids the firer in maintaining proper sight alignment (Figure 5-47).

Sight picture. Once the soldier can correctly align his sights, he can obtain a sight picture. A correct sight picture has the target, front sight post, and rear sight aligned. The sight picture includes two basic elements: sight alignment and placement of the aiming point.

Placement of the aiming point varies, depending on the engagement range. For example, Figure 5-48 shows a silhouette at 250 meters--the aiming point is the center of mass, and the sights are in perfect alignment; this is a correct sight picture.

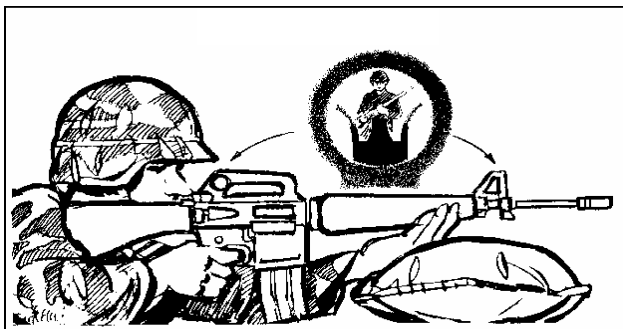

Figure 5-48. Correct Sight Picture.

A technique to obtain a good sight picture is the side aiming technique (Figure 5-49). It involves positioning the front sight post to the side of the target in line with the vertical center of mass, keeping the sights aligned. The front sight post is moved horizontally until the target is directly centered on the front sight post.

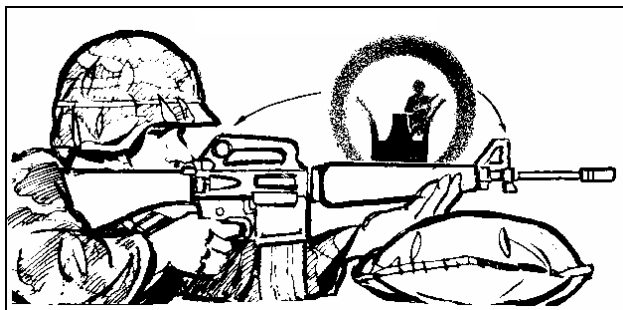

Figure 5-49. Side Aiming Technique

Front sight. The front sight post is vital to proper firing and should be replaced *when damaged*. Two techniques that can be used are the carbide lamp and the burning plastic spoon. The post should be blackened anytime it is shiny since precise focusing on the tip of the front sight post cannot be done otherwise.

Aiming practice. Aiming practice is conducted before firing live rounds. During day firing, the soldier should practice sight alignment and placement of the aiming point. This can be done by using training aids such as the M15AI aiming card and the Riddle sighting device.

Breath Control. As the firer's skills improve and as timed or multiple targets are presented, he must learn to hold his breath at any part of the breathing cycle. Two types of breath control techniques are practiced during dry fire.

- The first is the technique used during zeroing (and when time is available to fire a shot) (Figure 5-50A). There is a moment of natural respiratory pause while breathing when most of the air has been exhaled from the lungs and before inhaling. Breathing should stop after most of the air has been exhaled during the normal breathing cycle. The shot must be fired before the soldier feels any discomfort.
- The second breath control technique is employed during rapid fire (short-exposure targets) (Figure 5-51B). Using this technique, the soldier holds his breath when he is about to squeeze the trigger.

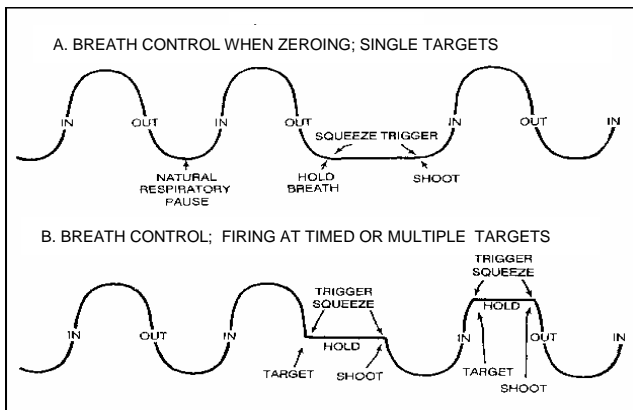

Rifle movement. Trigger squeeze is important for two reasons:

- First, any sudden movement of the finger on the trigger can disturb the lay of the rifle and cause the shot to miss the target.
- Second, the precise instant of firing should be a surprise to the soldier.

The soldier's natural reflex to compensate for the noise and slight punch in the shoulder can cause him to miss the target if he knows the exact instant the rifle will fire. The soldier usually tenses his shoulders when expecting the rifle to fire, but it is difficult to detect since he does not realize he is flinching. When the hammer drops on a dummy round and does not fire, the soldier's natural reflexes demonstrate that he is improperly squeezing the trigger.

Trigger finger. The trigger finger (index finger on the firing hand) is placed on the trigger between the first joint and the tip of the finger (not the extreme end) and is adjusted depending on hand size, grip, and so on. The trigger finger must squeeze the trigger to the rear so that the hammer falls without disturbing the lay of the rifle. When a live round is fired, it is difficult to see what affect trigger pull had on the lay of the rifle. Therefore, it is important to experiment with many finger positions during dry-fire training to ensure the hammer is falling with little disturbance to the aiming process.

As the firer's skills increase with practice, he needs less time spend on trigger squeeze. Novice firers can take five seconds to perform an adequate trigger squeeze, but, as skills improve, he can squeeze the trigger in a second or less. The proper trigger squeeze should start with slight pressure on the trigger during the initial aiming process. The firer applies more pressure after the front sight post is steady on the target and his is holding his breath.

The coach/trainer observes the trigger squeeze, emphasizes the correct procedure, and checks the firer's applied pressure. He places his finger on the trigger and has the firer squeeze the trigger by applying pressure to the coach/trainer's finger. The coach/trainer ensures that the firer squeezes straight to the rear on the trigger avoiding a left or right twisting movement. A steady position reduces disturbance of the rifle during trigger squeeze.

From an unsupported position, the firer experiences a greater wobble area than from a supported position. Wobble area is the movement of the front sight around the

aiming point when the rifle is in the steadiest position. If the front sight strays from the target during the firing process, pressure on the trigger should be held constant and resumed as soon as sighting is corrected. The position must provide for the smallest possible wobble area. From a supported position, there should be minimal wobble area and little reason to detect movement. If movement of the rifle causes the front sight to leave the target, more practice is needed. The firer should never try to quickly squeeze the trigger while the sight is on the target. The best firing performance results when the trigger is squeezed continuously, and the rifle is fired without disturbing its lay.

FIRING POSITIONS

All firing positions are taught during basic rifle marksmanship training. During initial fundamental training, the basic firing positions are used. The other positions are added later in training to support tactical conditions.



Figure 5-51. Supported Fighting Position

Basic Firing Positions. Two firing positions are used during initial fundamental training: the individual supported fighting position and prone unsupported position. Both offer a stable platform for firing the rifle. They are also the positions used during basic record fire.

Supported fighting position. This position provides the most stable platform for engaging targets (Figure 5-51). Upon entering the position, the soldier adds or removes dirt, sandbags, or other supports to adjust for his height. He then faces the target, executes a half-face to his firing side, and leans forward until his chest is against the firing-hand corner of the position. He places the rifle handguard in a V formed by the thumb and fingers of his nonfiring hand, and rests the nonfiring hand on the material (sandbags or berm) to the front of the position. The soldier places the stock butt in the pocket of his firing shoulder and rests his firing elbow on the ground outside the position. (When prepared positions are not available, the prone supported position can be substituted.)

Once the supported fighting position has been mastered, the firer should practice various unsupported positions to obtain the smallest possible wobble area during final aiming and hammer fall. The coach/trainer can check the steadiness of the position by observing movement at the forward part of the rifle, by looking through the M16 sighting device, or by checking to see that support is being used.

NOTE: The objective is to establish a steady position under various conditions. The ultimate performance of this task is in a combat environment. Although the firer must be positioned high enough to observe all targets, he must

remain as low as possible to provide added protection from enemy fire.

Prone unsupported position. This firing position (Figure 5-52) offers another stable firing platform for engaging targets. To assume this position, the soldier faces his target, spreads his feet a comfortable distance apart, and drops to his knees. Using the butt of the rifle as a pivot, the firer rolls onto his nonfiring side, placing the nonfiring elbow close to the side of the magazine. He places the rifle butt in the pocket formed by the firing shoulder, grasps the pistol grip with his firing hand, and lowers the firing elbow to the ground. The rifle rests in the V formed by the thumb and fingers of the nonfiring hand. The soldier adjusts the position of his firing elbow until his shoulders are about level, and pulls back firmly on the rifle with both hands. To complete the position, he obtains a stock weld and relaxes, keeping his heels close to the ground.

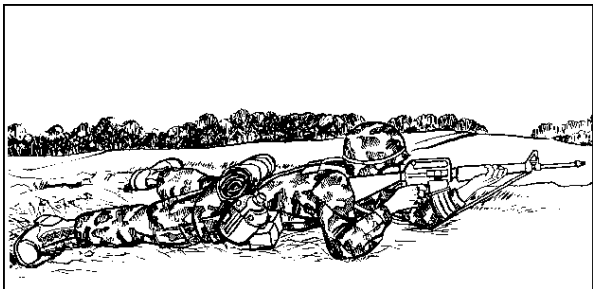

Figure 5-52. Prone Unsupported Position

POSITION OF THE COACH

The coach constantly checks and assists the firer *in applying marksmanship* fundamentals during firing. He observes the firer's position and his application of the steady position elements. The coach is valuable in checking factors the firer is unable to observe for himself and in preventing the firer from repeating errors.

During an exercise, the coach should be positioned where he can best observe the firer when he assumes position. He then moves to various points around the firer (sides and rear) to check the correctness of the firer's position.

The coach requires the firer to make adjustments until the firer obtains a correct position. When the coach is satisfied with the firing position, he assumes a coaching position alongside the firer. The coach usually assumes a position like that of the firer (Figure 5-53), which is on the firing side of the soldier.

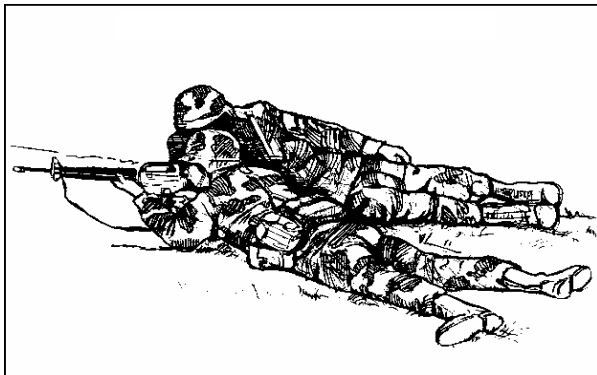

Figure 5-53. Prone position of coach (right-handed firer).

CHECKLIST FOR THE COACH

The procedures to determine and eliminate rifle and firer deficiencies follows.

The coach checks to see that the--

- Rifle is cleared and defective parts have been replaced.
- Ammunition is clean, and the magazine is properly placed in the pouch.
- Sights are blackened and set correctly for small (day) aperture vs. large (limited visibility).

The coach observes the firer to see that he--

- Uses the correct position and properly applies the steady-position elements.
- Properly loads the rifle.
- Obtains the correct sight alignment (with the aid of an M16 sighting device).
- Holds his breath correctly (by watching his back at times).
- Applies proper trigger squeeze; determines whether he flinches or jerks by watching his head, shoulders, trigger finger, and firing hand and arm.
- Is tense and nervous. If the firer is nervous, the coach has the firer breathe deeply several times to relax.

Supervisory personnel and peer coaches correct errors as they are detected. If many common errors are observed, it is appropriate to call the group together for more discussion and demonstration of proper procedures and to provide feedback.

ZERO AN M16A2 RIFLE

071-311-2030

CONDITIONS

On a 25-meter range, given an M16A2 rifle, 18 rounds of 5.56-mm ammunition, a 300-meter zero target, and sandbags for support. One of the following situations exists:

1. You receive a rifle that you have never fired.
2. Your rifle is returned after repair.
3. You think something may have changed the battlesight zero.

STANDARDS

Battlesight zero your rifle so that five out of six rounds, in two consecutive shot groups, strike within the 4-centimeter circle on the target. Use 18 rounds or less. Bullets that break the line of the 4-centimeter circle are acceptable.

TRAINING AND EVALUATION

Training Information Outline

1. Determine if you must establish a mechanical zero for the rifle. The rifle must have the mechanical zero established if the rifle—
 - a. Is being returned to service after direct support (DS) or general support (GS) maintenance.
 - b. Has not been zeroed for you.

- c. Has been dropped or otherwise damaged.
2. Select the unmarked, long-range aperture (small peep sight) on the rear sight for zeroing (Figure 5-43).
 3. Set the sights to the mechanical zero, if required.
 - a. Set the front sight (consisting of a rotating post with a spring-loaded detent).
 - 1) Depress the detent using a pointed object or a sight adjustment tool.
 - 2) Rotate the post up or down so the notched disk is flush with the top of the front sight post well.
 - b. Set the rear sight to the center.
 - 1) Align the index mark on the 0-2 aperture with the center line on the windage scale and the mark on the receiver.
 - 2) Rotate the elevation knob down until the range scale mark "8/3" is aligned with the mark on the left side of the receiver.
 - 3) Rotate the elevation knob one click clockwise past the "8/3" mark.

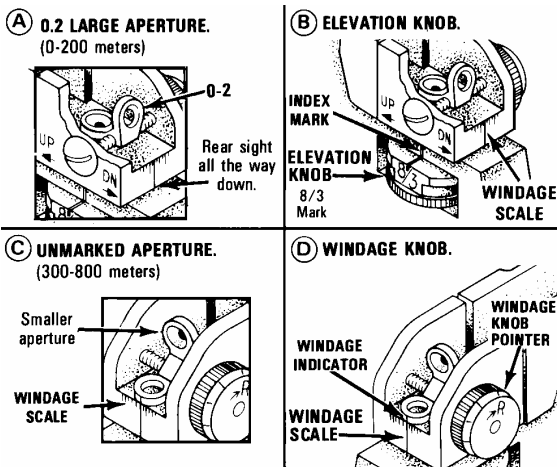

Figure 5-43. Rear sight.

NOTE: The sight picture is obtained by aligning the rear sight and the front sight with the proper aiming point for your target. The sight picture depends on sight alignment and placement of the aiming point.

4. Establish the sight picture.
 - a. Align the sights (Figure 5-44).
 - b. Center the top of the front sight post in the center of the rear sight (A, Figure 5-44).
 - c. Draw an imaginary horizontal line through the center of the rear aperture so that the top of the front sight post touches the line (B, Figure 5-44).

d. Draw an imaginary vertical line through the center of the rear aperture that bisects the front sight post (C, Figure 5-44).

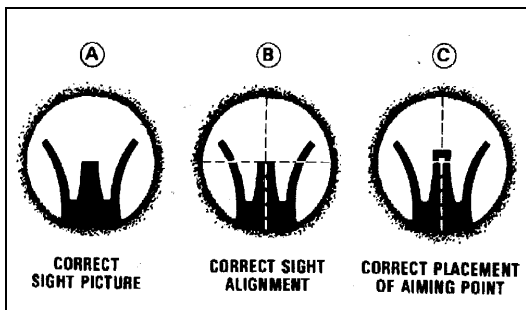

Figure 5-44. Sight pictures.

5. Verify the sight picture.

NOTE: When you concentrate on the front sight post, the rear sight aperture will be blurred.

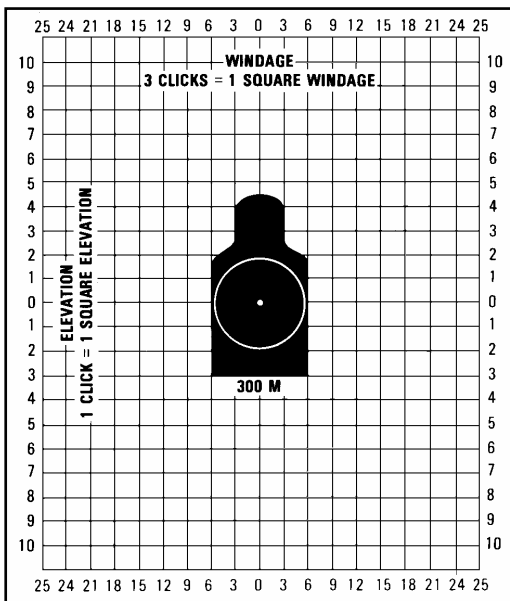

Figure 5-45. Sight adjustments.

- Align the aiming point (Figure 5-45).
- Position the top of the front sight post center mass of the scaled silhouette target.
- Confirm that an imaginary vertical line drawn through the center of the front sight post splits the target.
- Confirm that an imaginary horizontal line drawn through the top of the front sight post splits the target.

6. Fire a three-round shot group at the target. Triangulate the shot group on the target.

7. Repeat steps 5 and 6 until the shot group falls within 4 centimeters.

NOTE: The target is divided by labeled vertical and horizontal lines. It also has pictures of the front and rear sights with a direction arrow to assist you with adjusting the sights.

8. Adjust the sights to move the shot group within the zero circle if required.

NOTE: Do not adjust the sights if the shot group meets the task standard.

a. Adjust the elevation.

1) Find the horizontal line (right-to-left) nearest the center of the shot group.

2) Follow the line either left or right to the nearest edge of the target.

3) Identify the number of clicks and the direction of the adjustment shown at the edge of the target.

4) Adjust the front sight in the indicated direction and number of clicks.

5) Record the adjustment made on the target.

b. Adjust the windage.

1) Find the vertical line (up-and-down) nearest the center of the shot group.

2) Follow the line either up or down to the nearest edge of the target.

3) Identify the number of clicks and the direction of the adjustment shown at the edge of the target.

4) Adjust the rear sight in the indicated direction and number of clicks.

5) Record the adjustment made on the target.

9. Fire a three-round shot group.

10. Repeat step 8 if the shot group is not within the 4-centimeter circle on the target.

11. Repeat steps 9 and 10 until 5 out of 6 shots from consecutive shot groups are within the circle.

12. Compute the battlesight zero using Table 5-46.

COMPUTATION		EXAMPLES	
		FRONT	REAR
Begin with mechanical zero (or previous battlesight zero)		Flush	Centered
Compute first adjustment	Add clicks right or up	-(D)2	+(R)5
	Subtract clicks to left or down		
Compute second adjustment		+(U)5	+(R)5
(Include additional corrections if necessary)			
Calculate battlesight zero (Total)		U3	R4

Table 5-46. Computing the battlesight zero.

13. Label the rifle with the battlesight zero.
 - a. Record the battlesight zero on the tape.
 - b. Attach the tape to the rifle.

M249 Squad Automatic Weapon

The M249 AR is a gas-operated, air-cooled, belt-and-magazine-fed, automatic weapon that fires from the open-bolt position (Figure 5-53). It has a maximum rate of fire of 850 rounds per minute. Primarily, ammunition is fed into the weapon from a 200-round ammunition box containing a disintegrating metallic split-link belt. As an emergency means of feeding, the M249 AR can use a 20- or 30-round M16 rifle magazine, but this will increase the chance of stoppages. Although the M249 AR is primarily used as an automatic rifle, it is also used as a light machine gun. It can be fired from the shoulder, hip, or underarm position; or from the bipod-steadied position. When employed as a machine gun, it has a tripod with a T&E mechanism and a spare barrel; however, barrels must not be interchanged with those from other M249s unless the headspace has been set for that weapon by direct support personnel.

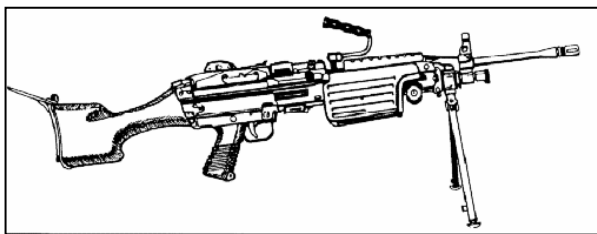

Figure 5-54. Squad Automatic Weapon

The M249 operations are loading, firing, unloading, and using belted ammunition or, in an emergency, a 20- or 30-

round M16 magazine. The firing operation works on gas pressure created as a fired round passes through the barrel. The M249 is loaded, fired, unloaded, and cleared from the open-bolt position. The safety must be in the FIRE position before the bolt can be pulled to the rear. Before using belted ammunition, it must be checked to ensure it is properly linked with the double link or the link tab at the open end of the box. It must be free of dirt and corrosion. When using a magazine of ammunition, it must be loaded into the magazine well and be free of dirt and corrosion.

CLEARING PROCEDURES

The first step in maintenance is to clear the weapon. This applies in all situations, not just after firing. The automatic rifleman must always assume the M249 AR is loaded. To clear the M249, the automatic rifleman performs the following procedures.

1. Moves the safety to the FIRE position by pushing it to the left until the red ring is visible.
2. With his right hand, palm up, pulls the cocking handle to the rear, locking the bolt in place.
3. While holding the resistance on the cocking handle, moves the safety to the SAFE position by pushing it to the right until the red ring is not visible. (The weapon cannot be placed on safe unless the bolt is locked to the rear.)
4. Returns and locks the cocking handle in the forward position.

CAUTION

When opening the feed cover, make sure the weapon is on the ground away from your face. With the weapon on your shoulder, possible injury could occur if a round goes off when the cover is raised.

5. Raises the cover and feed mechanism assembly, and conducts the five-point safety check for brass, links, or ammunition.
6. Checks the feed pawl assembly under the feed cover.
7. Checks the feed tray assembly.
8. Lifts the feed tray assembly and inspects the chamber.
9. Checks the space between the bolt assembly and the chamber.
10. Inserts two fingers of his left hand in the magazine well to extract any ammunition or brass.
11. Closes the cover and feed mechanism assembly and moves the safety to the FIRE position. With his right hand, palm up, returns the cocking handle to the rear position. Presses the trigger and at the same time eases the bolt forward by manually riding the cocking handle forward.

LOAD AN M249

To load the M249 AR, make sure the weapon is cleared. (With the feed cover raised, make sure your face is not exposed to the open chamber area when loading.)

When loading belted ammunition, always cant the weapon to the right. Make sure the open side of the links is facing down, and place the lead link tab or first round of the belt in the tray groove against the cartridge stop. The rounds should be placed flat across the feed tray. With your left hand, count five to six rounds down to hold ammunition in place on the feed tray, while at the same time close the feed cover with your right hand. When closing the feed cover, always place your hand in front of the rear sight to prevent accidentally changing the sight adjustment. NOTE: The 20- or 30-round magazine is for emergency use only when linked ammunition is not available.

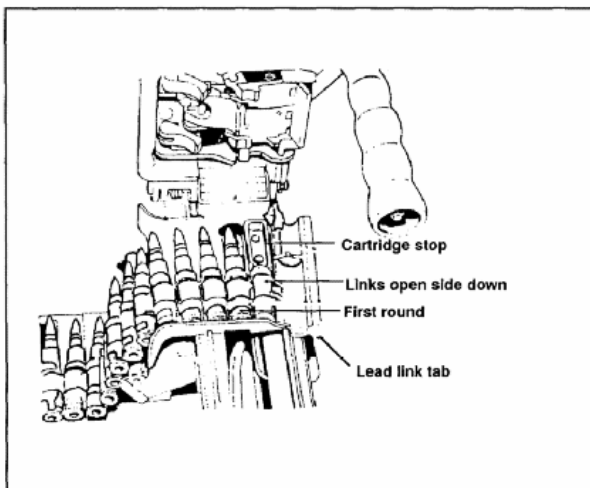
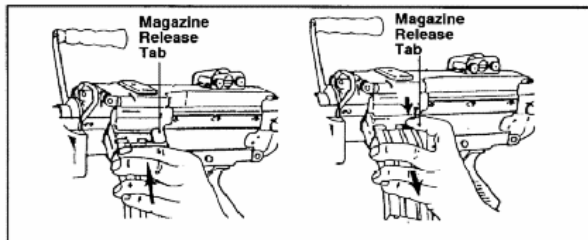

Figure 5-55. Belt-Fed.

Magazine-Fed. Load the 20-or 30-round magazine by inserting it into the magazine well on the left side of the receiver. Push the magazine firmly into the well until it seats and the release tab clicks into the recess on the magazine.



UNLOAD AN M249

To unload the weapon, pull the bolt and lock it in the rear position if not already there. Place the safety on SAFE. Depending on whether belt-fed or magazine-fed ammunition is used, use the following procedures.

CAUTION

Before you raise the feed cover, move the weapon away from your face so that you are not exposed to the open chamber.

1. Belt-Fed. Raise the feed cover and remove any ammunition or links from the feed tray. Perform the five-point safety check.

2. Magazine-Fed. Push the magazine release tab down and pull the magazine from the magazine well. Raise the feed cover and perform the five-point safety check.

CORRECT MALFUNCTIONS OF AN M249

A malfunction occurs when a mechanical failure causes the weapon to fire improperly. Defective ammunition or improper operation by the automatic rifleman is not considered a malfunction. If cleaning and or lubricating the weapon does not fix the problem, then it is turned in to the unit armorer.

A stoppage is any interruption in the cycle of functioning caused by faulty action of the weapon or faulty ammunition. Stoppages are classified by their relationship to the cycle of functioning.

Immediate action is action taken to reduce a stoppage without looking for the cause. Immediate action should be taken in the event of a misfire or a cookoff. A misfire is the failure of a chambered round to fire. Such failure can be due to an ammunition defect or faulty firing mechanism. A cookoff is the firing of a round by the heat of a hot barrel and not by the firing mechanism. Cookoffs can be avoided by applying immediate action within 10 seconds of a failure to fire. The automatic rifleman keeps the AR on his shoulder while performing immediate action procedures. If the M249 stops firing, the following immediate actions are taken. (An effective memory aid is POPP, which stands for Pull, Observe, Push, and Press.)

1. Pull and lock the cocking handle to the rear while observing the ejection port to see if a cartridge case, belt link, or round is ejected. Ensure that the bolt remains to the rear to prevent double feeding if a round or cartridge case is not ejected.
2. If a cartridge case, belt link, or a round is ejected, push the cocking handle to its forward position, take aim on the target, and press the trigger. If the weapon does not fire, take remedial action. If a cartridge case, belt link, or round is not ejected, take remedial action.

DANGER

If nothing is ejected and the barrel is hot (200 or more rounds fired in less than 2 minutes), do not open the cover. Push the safety to the right (red ring not visible), which places the weapon on safe. Keep the weapon pointed downrange and remain clear for 15 minutes, then clear the weapon.

REFERENCES

FM 23-14

FM 23-67

TM 9-1005-224-10

HAND GRENADES

PERFORM SAFETY CHECKS ON HAND GRENADES 071-325-4401

CONDITIONS

Given any standard issue US hand grenade with extra safety clips and load carrying equipment (LCE).

STANDARDS

Inspect the grenade for defects; identify and correct defects, if possible. Report and turn in grenades that have defects you cannot correct. Identify each grenade by type and correctly attach grenades to your ammunition pouch.

TRAINING AND EVALUATION

Training Information Outline

1. Identify the grenades listed in Table 5-57, by type, color, markings, and usage.
2. Inspect hand grenades for defects; correct defects, if possible.
 - a. Check the fuse to ensure it is screwed tightly on the body of the grenade.
 - b. Check the safety clip to ensure:
 - 1) It is present.
 2. It is in the correct position.

TYPE	COLOR/MARKINGS	USAGE
M67	OD with yellow marking.	Disables or kills enemy. Explodes 4 to 5 seconds after the safety lever is released.
M18 Colored Smoke	OD with color of smoke on top.	Signals personnel.
M34 WP Smoke	Light green, yellow band, red marking "OLD MARKING" light gray, yellow band, yellow printing.	Signals personnel. Produces casualties up to 35 meters away.
AN-M8 HC Smoke	Light green, black marking, white top.	Screens, "provides concealment."
AN-M14 TH3 Incendiary	Light red with black lettering.	Destroys equipment and starts fires.
ABC-M25A2 CS Riot Control	Gray, red bands and markings.	Controls riots or disables enemy without serious injury.

Table 5-57. Hand grenades.

3. Inspect hand grenades for defects; correct defects, if possible.

a. Check the fuse to ensure it is screwed tightly on the body of the grenade.

b. Check the safety clip to ensure:

1) It is present.

- 2) It is in the correct position.

NOTE: Perform step 2C only if necessary.

- c. Replace missing safety clips.
 - 1) Slide the clip onto the handle.
 - 2) Attach the loop portion of the clip around the fuse.
 - 3) Snap the clip end around the safety lever.
- d. Check the safety pin.
- e. Ensure the clip is in the correct position. If not in position, carefully push it into place while holding the safety lever down.
- f. Ensure the clip is not bent. If it is bent, carefully bend it back in position.
- g. Check the safety ring for cracking and reject the grenade with a cracked safety ring.
- h. Check grenades for dirt, wiping dirty or grimy grenades with a cloth.
- i. Turn in defective grenades.

WARNING

Do not attempt to modify a grenade. Do not attempt to defuse a grenade. Do not attempt to remove a grenade found upside down in its packing container. Do not handle a dud grenade. Do not attach grenades to clothing or equipment by the pull ring.

4. Attach the grenade to an ammunition pouch.
 - a. Attach the grenade to the new style pouch.
 - 1) Slip the grenade safety lever over the small strap (sewn to each side of the ammunition pouch).
 - 2) Push the grenade down until it is firmly seated against the side of the pouch.
 - 3) Ensure the pull ring is pointed downward.
 - 4) Wrap the carrying strap around the fuse including both the safety lever and the pull ring.
 - b. Attach the grenade to the old style pouch.

NOTE: A small strap is sewn to each side of the pouch.

- 1) Slip the safety lever over the strap and push the grenade down until it is firmly seated against the side of the pouch.
 - 2) Ensure the pull ring is pointed downward, wrapping the carrying strap around the fuse, including the safety lever and pull ring.
5. Check grenades occasionally while moving to ensure the fuse is tight and the strap is secure.

EMPLOY HAND GRENADES

071-325-4407

CONDITIONS

Given an offensive (concussion), riot control, smoke, or incendiary grenade with a time-delay fuse and load-carrying equipment (LCE).

STANDARDS

Throw the hand grenade to hit the target without exposing yourself for more than 5 seconds.

TRAINING AND EVALUATION

Training Information Outline

1. Position your body in a comfortable and natural position.
 - A. Make sure you are in a covered position.
 - B. Look at the target and judge the distance to the target.
 - C. Align your body with the target as if you were going to throw a football or baseball.

NOTE: This method is called body target alignment.

2. Grip the hand grenade as follows:
 - A. Hold the safety lever down with your thumb.

B. Keep the pull ring and safety clip (if present) free and facing your throwing hand.

3. Arm the grenade.

A. Remove the safety clip.

NOTE: Hold the safety lever down by your thumb. This keeps the pull ring and safety clip free and facing the non-throwing hand.

B. Pull the pin.

4. Confirm body-target alignment.

TARGET	EFFECTIVE ENGAGEMENT
Troops in the open.	Within 5 meters of center.
Troops with overhead cover.	Inside the enclosure.
Troops dug in without overhead cover.	Inside the position.

5. Toss the grenade using an overhand movement.

Release the grenade when it comes into your field of vision ensuring that you:

A. Keep your eyes on the target.

B. Follow through your throwing motion.

C. Take cover, exposing yourself to fire for no more than 5 seconds.

6. Return to the position behind cover until the grenade is detonated, exposing yourself for no more than 5 seconds at any one time.
7. Detonate the grenade within the effective bursting radius of the target.

CLAYMORE MINE

EMPLOY AN M18A1 CLAYMORE MINE 071-325-4425

CONDITIONS

You must employ the M18A1 Claymore mine against enemy targets. Given an M18A1 Claymore mine in a bandoleer, an M57 firing device, an M40 test set, and a firing wire with blasting cap, packed in an M7 bandoleer; a sandbag; and two wooden stakes.

STANDARDS

1. Conduct a circuit test of the firing device with the blasting cap secured under a sandbag.
2. Install the M18A1 Claymore mine so that—
 - a. The front of the mine is centered on a kill zone.
 - b. The firing device is 16 meters to the rear or side of the emplaced mine and is fired from a covered position.
 - c. The mine, firing wire and firing device are camouflaged.

d. The installation is confirmed by conducting a final circuit test.

3. Fire the mine by actuating the firing device handle with a firm, quick squeeze when the target is in the kill zone.

TRAINING AND EVALUATION

Training Information Outline

1. Inventory the M18A1 Claymore mine bandoleer, accounting for all accessories in the bandoleer (Figure 5-58).

WARNING

During testing and installation, keep the M57 firing device in your possession to prevent accidental firing by someone else.

2. Conduct a circuit test at the firing point (Figure 5-59).

a. Remove the electrical wire and accessories while leaving the mine in the bandoleer.

b. Remove the dust cover from the connector of the M57 firing device and from the female connector of the M40 test set.

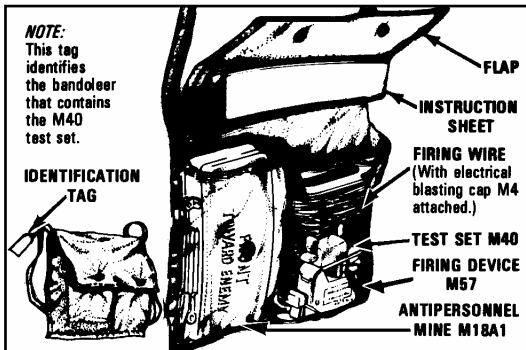

Figure 5-58. Components of the M18A1 Claymore mine.

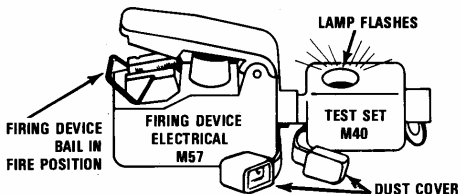

Figure 5-59. Circuit test of the M57 firing device and M40 test set.

- c. Plug the test set into the firing device.
- d. Position the firing device bail to the FIRE position.
- e. Actuate the handle of the firing device with a firm, quick squeeze, observing the flash of light through the window of the test set.

NOTE: The flashing light indicates that the M57 firing device and M40 test set are functioning correctly.

f. Remove the shorting plug cover from the connector of the firing wire and from the end of the test set.

g. Plug the connector of the firing wire into the test set (Figure 5-60).

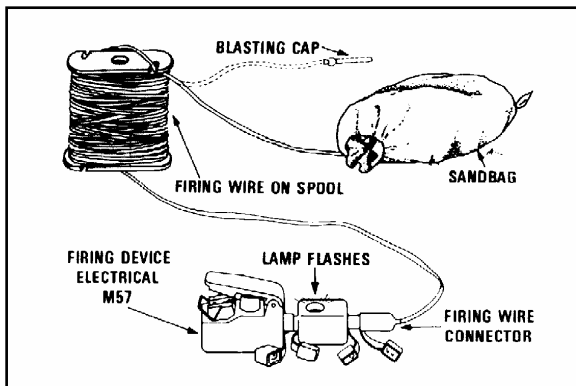

Figure 5-60. Circuit test of the M18A1 Claymore mine firing system.

WARNING

The blasting cap must be placed under a sandbag, behind a tree or in a hole in the ground to protect the person performing the circuit check in case the blasting cap detonates.

h. Place the M57 firing device bail in the FIRE position and actuate the firing handle.

NOTE: The lamp in the window of the M40 test set should flash.

- i. Place the firing device on SAFE, remove the M57 firing device and M40 test set.
 - j. Place the shorting plug cover on the firing wire.
3. Install the M18A1 Claymore mine.
- a. Tie the shorting plug end of the firing wire to a fixed object, such as a stake or tree at the firing position (Figure 5-61).

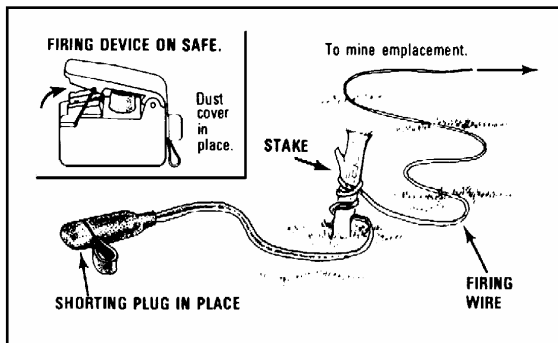

Figure 5-61. Firing wire secured.

- b. Place the bandoleer on your shoulder.
 - c. Unroll the firing wire to the selected installation position.
- NOTE:** The firing wire is laid from the firing position to the mine installation site because the blasting cap end is on the inside of the firing wire spool.

4. Aim the mine.

a. Remove the mine from the bandoleer.

b. Open both pairs of legs to a 45-degree angle with two legs facing to the front and two legs facing to the rear of the mine (Figure 5-62).

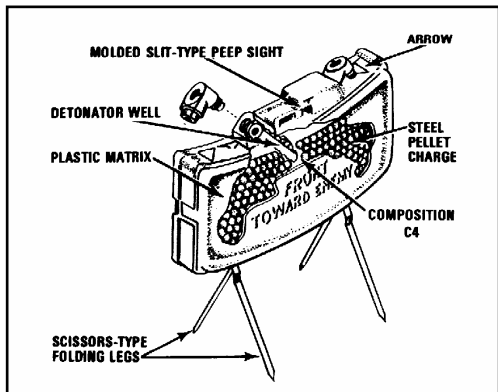

Figure 5-62. Placing and aiming the mine.

c. Push the legs about one-third of the way into the ground with the mine facing in the desired direction of fire. In windy areas or when the legs cannot be pressed into the ground, spread the legs as far as they will go (about 180 degrees) so that the legs are to the front and rear of the mine and the mine will not tip over.

- d. Select an aiming point at ground level about 50 meters (150 feet) in front of the mine (Figure 5-63).

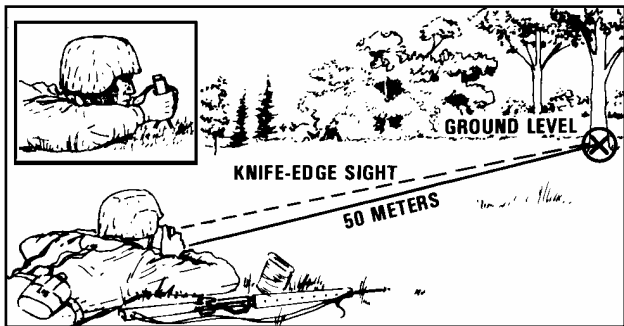

Figure 5-63. Aiming knife-edge sight.

- e. Position one eye about 6 inches to the rear of the sight.
- f. On a knife-edge sight, align the two edges of the sight with the aiming point (Figure 5-64).

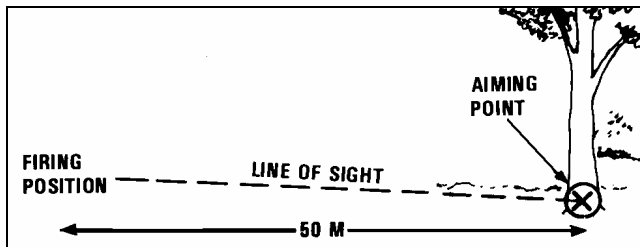

Figure 5-64. Aiming knife-edge sight

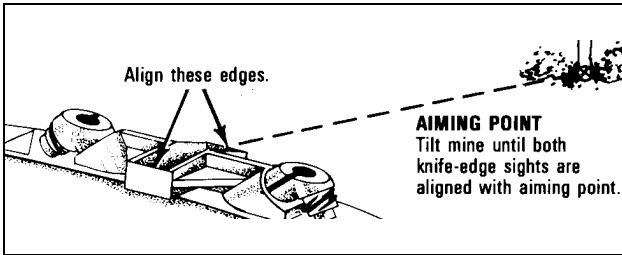

Figure 5-64. Aiming knife-edge sight (continued).

g. On a split-type peep sight, align the groove of the sight in line with the aiming point that is 2.5 meters (8 feet) off the ground (Figure 5-65).

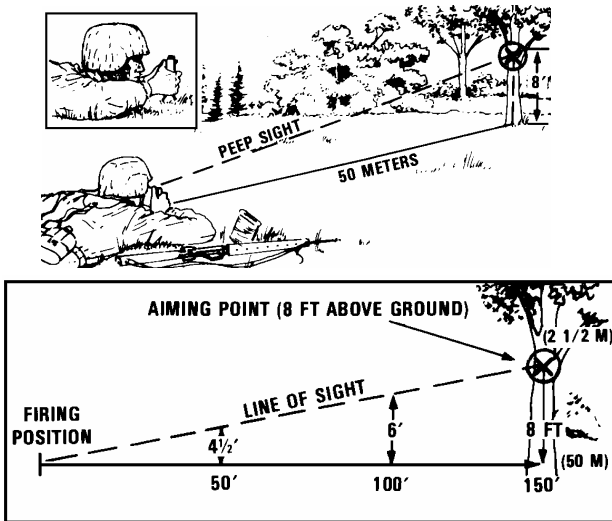

Figure 5-65. Aiming split-type peep sight.



Figure 5-66. Aiming split-type peep sight (continued).

5. Arm the mine.

- a. Secure the firing wire about 1 meter to the rear of the mine so the mine will not become misaligned if the firing wire is disturbed.
- b. Unscrew one of the shipping plug priming adapters from the mine.

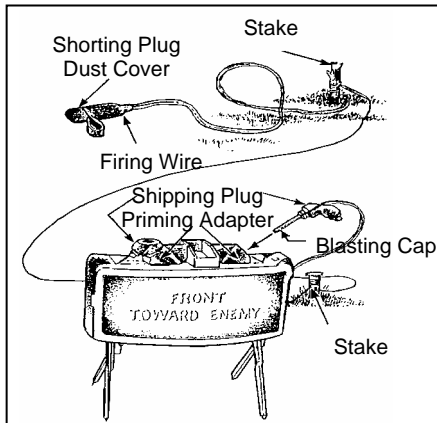

Figure 5-67. Arming the mine.

c. Slide the slotted end of the shipping plug priming adapter onto the firing wire of the blasting cap between the crimped connections and the blasting cap.

d. Pull the excess wire through the slotted end of the adapter until the top of the blasting cap is firmly seated in the bottom portion of the shipping plug priming adapter (Figure 5-67).

e. Screw the adapter, with the blasting cap, into the detonator well.

WARNING

Ensure that the face of the mine marked "front toward enemy" and the arrows on the mine point in the direction of the enemy.

f. Recheck the aim of the mine.

6. Camouflage the mine.

a. Bury the firing wire (if possible) from the mine back to the firing position.

NOTE: The firing position should be in a hole or covered position at least 16 meters to the rear or the side of the emplaced mine.

WARNING

The M40 test set must be used during retest of the circuit.

7. Repeat step 2 to test the circuit after the firing wire is laid out and the cap is placed inside the mine to see if any breaks in the wire have occurred (Figure 5-68).

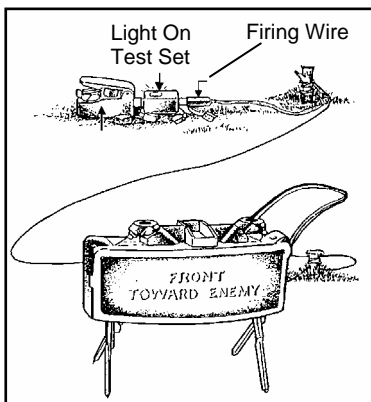

Figure 5-68. Retesting the circuit.

NOTES: 1. To ensure that the mine will function properly after installation, retesting the firing circuit will check for any break in the wire that may have occurred during the installation.

8. Friendly troops within 250 meters to the front and sides and 100 meters to the rear of the mine must be under cover.

WARNING

You must be behind cover or in a fighting position when retesting the circuit on a claymore mine with the blasting cap inserted in the detonation well.

9. Fire the mine.

- a. Remove the dust cover from the firing device and firing wire.
- b. Connect the firing wire to the firing device.
- c. Position the firing device safety bail in the FIRE position (Figure 5-69).

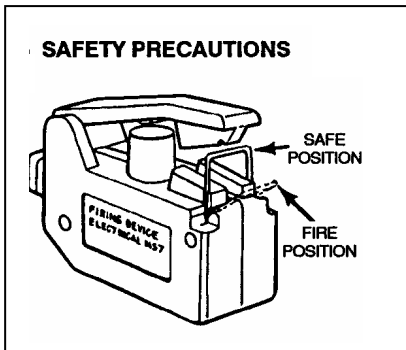

Figure 5-69. Firing device in the SAFE position.

- d. Actuate the firing device handle with a firm, quick squeeze.
- e. Assume a prone position behind cover.

NOTE: The mine is most effective when employed against targets 20 to 30 meters in front of it.

RECOVER AN M18A1 CLAYMORE MINE

071-325-4426

CONDITIONS

Given an installed M18A1 Claymore mine, an M57 firing device, an M40 test set, a firing wire spool, and an M7 bandoleer, you must remove an installed mine.

STANDARDS

Recover the M18A1 Claymore mine, disarming it without activating the mine. Repack all components into the M7 bandoleer.

TRAINING AND EVALUATION

Training Information Outline

1. Disarm the M18A1 Claymore mine.
 - a. Check the firing device safety bail to ensure it is on SAFE.
 - b. Disconnect the firing device from the wire.
 - c. Replace the shorting plug dust cover on the firing wire connector.
 - d. Replace the dust cover on the firing device connector.
 - e. Keep possession of the M57 firing device.

WARNING

During disarming and recovery of the M18A1 claymore mine, keep the M57 firing device in your possession.

- f. Untie the firing wire from the stake at the firing site.
 - g. Move to the M18A1 Claymore mine.
 - h. Remove the shipping plug priming adapter by unscrewing it from the blasting cap.
 - i. Separate the shipping plug priming adapter and the blasting cap.
 - j. Reverse the shipping plug.
 - k. Screw the shipping plug end of the adapter into the detonator well.
 - l. Remove the firing wire from the stake at the mine site.
 - m. Place the blasting cap into the end of the wire connector.
 - n. Roll the wire on the wire container.
2. Remove the M18A1 Claymore mine.
- a. Lift the M18A1 Claymore mine from its emplacement.
 - b. Secure the folding legs.

c. Repack the mine and all the accessories into the M7 bandoleer.

M203 GRENADE LAUNCHER

Table 5-70 lists characteristics of the M203 grenade launcher.

Length of rifle with launcher	39 inches
Weight Launcher loaded Rifle and launcher loaded	3.5 pounds 11 pounds
Ammunition Caliber Weight	40-mm 8 ounces (approximate)
Maximum Range	400 meters
Maximum Effective Range Area target Point target	350 meters 150 meters
Minimum Safe Firing Range (HE) Training Combat	165 meters 31 meters
Rate of Fire	5 to 7 rounds per minute
Minimum Combat Load	36 HE rounds

Table 5-70. Characteristics of the M203 grenade launcher (continued).

LOAD AN M203 GRENADE LAUNCHER

071-311-2127

CONDITIONS

Given an M203 grenade launcher and ammunition.

STANDARDS

Load the M203 using correct procedures while observing all safety precautions.

TRAINING AND EVALUATION

Training Information Outline

1. Load the M203 (Figure 5-71).

a. Press the barrel latch and slide the barrel forward (A, Figure 5-71).

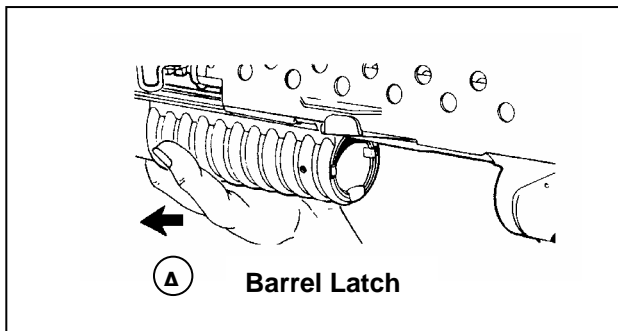

Figure 5-71. Loading the M203.

b. Place the weapon on SAFE until ready to fire (B, Figure 5-71).

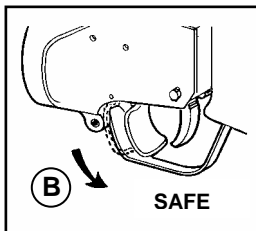

Figure 5-71. Loading the M203 (continued).

WARNING

Keep the muzzle pointed downrange and clear of all troops.

2. Insert the ammunition into the chamber (C, Figure 5-71).
3. Slide the barrel rearward until it locks (D, Figure 5-71).

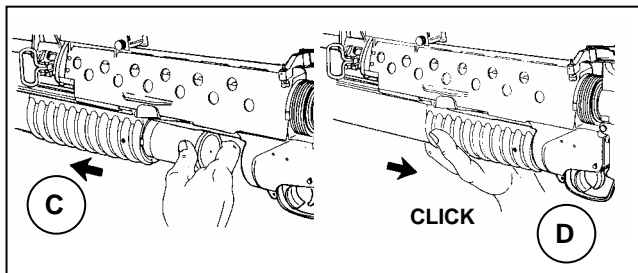

Figure 5-71. Loading the M203 (continued).

UNLOAD AN M203 GRENADE LAUNCHER

071-311-2128

CONDITIONS

Given a loaded M203 grenade launcher.

STANDARDS

Unload the M203 using the correct procedures while observing all safety precautions.

TRAINING AND EVALUATION

Training Information Outline

CAUTION

If the weapon was not fired, use extreme caution during unloading procedures. Where circumstances permit, either catch the ejected round or reduce the distance it falls by holding the weapon close to the ground.

1. Depress the barrel latch and move the barrel forward. The casing or the round should automatically eject.

2 Place the weapon on SAFE.

NOTE: If the casing is stuck, remove it by tapping it with a cleaning rod.

3. Slide the barrel rearward, locking it to the breech.

M136 AT4 LIGHT ANTIARMOR WEAPON

The M136 AT4 is a lightweight, self-contained, antiarmor weapon. It consists of a free-flight, fin-stabilized, rocket-type cartridge packed in an expendable, one-piece, fiberglass-wrapped tube (Figure 5-72). The M136 AT4 is man-portable and is fired from the right shoulder only. The launcher is watertight for ease of transportation and storage. Though the M136 AT4 can be employed in limited visibility, the firer must be able to see and identify the target and estimate the range to it. Unlike the M72-series LAW, the M136 AT4 launcher need not be extended before firing.

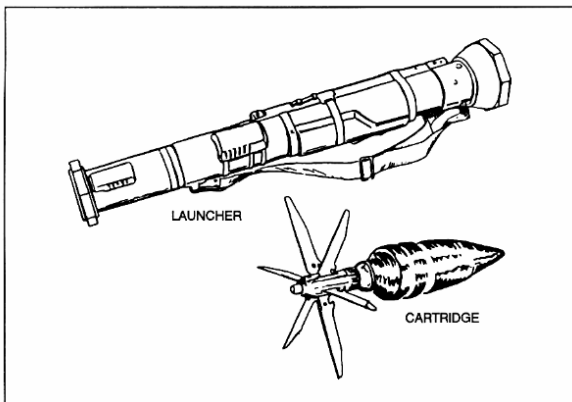

Table 5-72. Components of the M136 AT4 weapon.

The following data apply to the M136 AT4:

a. Launcher.

Length 1,020 mm (40 inches)
Weight (Complete System) . 6.7 kg (14.8 pounds)
Rear Sight..... Range indicator, graduated
in 50-meter increments

b. Rocket.

Caliber 84 mm
Muzzle Velocity..... 290 mps (950 fps)
Length 460 mm (18 inches)
Weight..... 1.8 kg (4 pounds)
Minimum Range Training ... 30 meters (100 feet)
Combat 10 meters (33 feet)
Arming..... 10 meters (33 feet)
Maximum Range..... 2,100 meters (6,890 feet)
Maximum Effective Range ... 300 meters (985 feet)

The M136 AT4 is a round of ammunition with an integral, rocket-type cartridge. The cartridge consists of a fin assembly with tracer element; a point-initiating, base-detonating, piezoelectric fuze; a warhead body with liner; and a precision-shaped explosive charge (Figure 5-72).

a. Description. The M136 AT4's warhead has excellent penetration ability and lethal after-armor effects. The extremely destructive, 440 gram shaped-charge explosive penetrates more than 14 inches (35.6 cm) of armor.

(1) **Impact.** The nose cone crushes; the impact sensor activates the fuze.

(2) **Ignition.** The piezoelectric fuze element activates the electric detonator. The booster detonates, initiating the main charge.

(3) **Penetration.** The main charge fires and forces the warhead body liner into a directional gas jet that penetrates armor plate.

(4) **After-armor effects (spalling).** The projectile fragments and incendiary effects produce blinding light and destroy the interior of the target.

b. **Color-Coding.** M136 AT4 launchers are marked with color-coded bands. A black with yellow band indicates an HE antiarmor round (early models had a solid black band). A gold or yellow band indicates a field handling trainer; no band indicates an M287 9-mm tracer bullet trainer.

PREPARE AN M136 LAUNCHER FOR FIRING 071-054-0001

CONDITIONS

Given an M136 launcher (AT4) and a requirement to prepare it for firing.

STANDARDS

Prefire checks are performed and the M136 is prepared for firing.

TRAINING AND EVALUATION

Training Information Outline

1. Perform the prefire checks. Because the M136 launcher is issued as a round of ammunition rather than as a weapon, the launcher is completely sealed. Therefore, inspection is limited to visual examination of the external components. The overall condition of the launcher should be inspected before it is used (Figure 5-73). The firer should ensure:

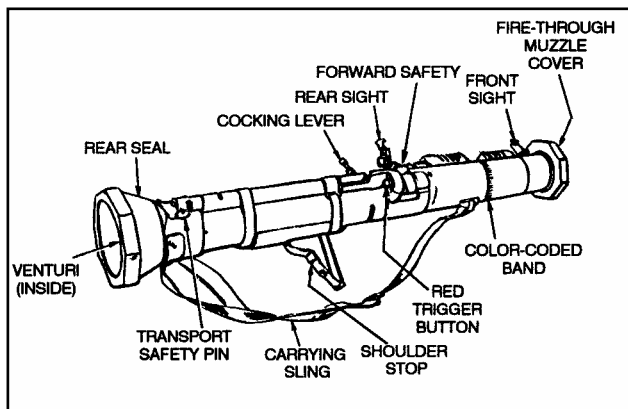

Figure 5-73. Inspecting the M136 launcher.

a. The transport safety pin is in place and fully seated, and the lanyard is attached (Figure 5-73).

b. The cocking lever is in the SAFE position and is folded down.

c. The fire-through muzzle cover is intact. If the seal is torn, it should be removed to ensure that no foreign objects have gotten into the launcher.

d. The launcher's color-coded band is the correct color: black for high-explosive antitank; gold for target-practice tracers; and blue for field-handling trainers.

e. The sights function properly. Open the sight covers to ensure the sights pop up and are not damaged.

f. The red safety catch does not move when depressed.

g. The rear seal is not damaged.

h. The shoulder stop is not broken or damaged and it unsnaps and folds down.

i. The carrying sling is not frayed and is attached to the launcher.

j. The launcher body has no cracks, dents, or bulges.

2. Prepare the launcher for firing. Preparation procedures are:

WARNING

Be sure personnel are wearing earplugs. Keep the weapon pointed toward the target. Keep the backblast area clear.

a. Remove the launcher from the carrying position and cradle it with the left arm (Figure 5-74).

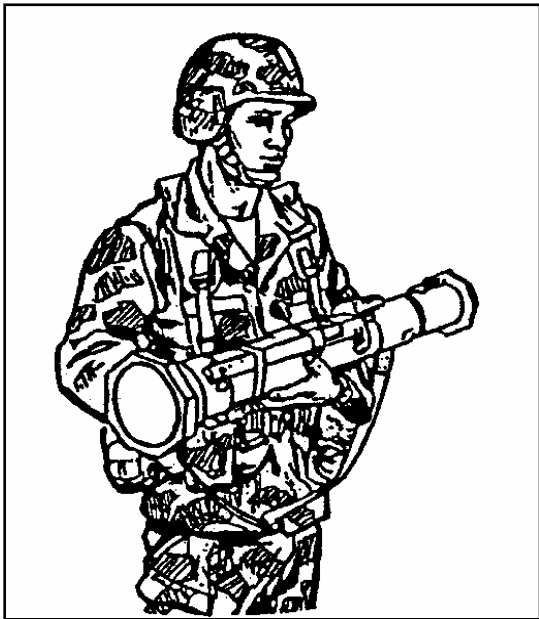

Figure 5-74. Using the cradle position.

b. While cradling the launcher, pull the transport safety pin with the right hand and release it (Figure 5-75).

NOTE: Ensure the transport safety pin is attached to the launcher by its lanyard. If there is no lanyard, place the transport safety pin in your pocket. If the launcher is not fired, the transport safety pin must be reinserted.

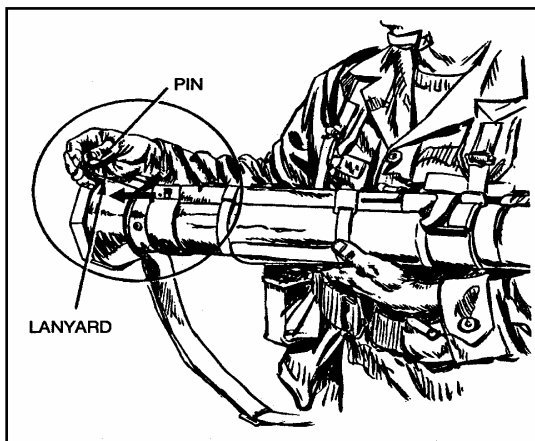

Figure 5-75. Removing the transport safety pin.

c. Unsnap and unfold the shoulder stop (Figure 5-76).

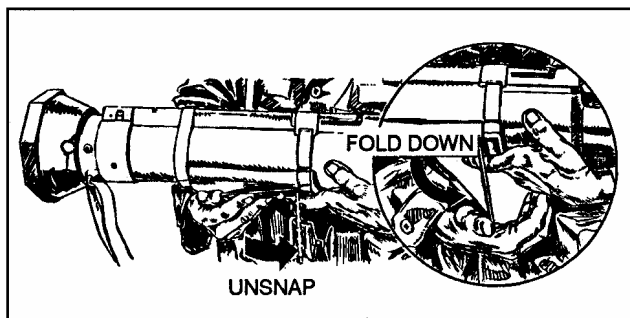

Figure 5-76. Unsnapping the shoulder stop.

d. With the shoulder stop in position, place the launcher on the right shoulder.

e. With the launcher on the right shoulder and supported with the right hand, release the front sight by pressing down on the sight cover and sliding it to the rear. Release the rear sight by pressing down on the cover and sliding it forward. Each sight will pop up when the covers are slid off.

f. Cock the launcher by unfolding the cocking lever with the right hand. Place the thumb of the right hand under the cocking lever. Grip the front of the firing mechanism for support. Push the cocking lever forward and down to the right. Let the cocking lever slide back (Figure 5-77).

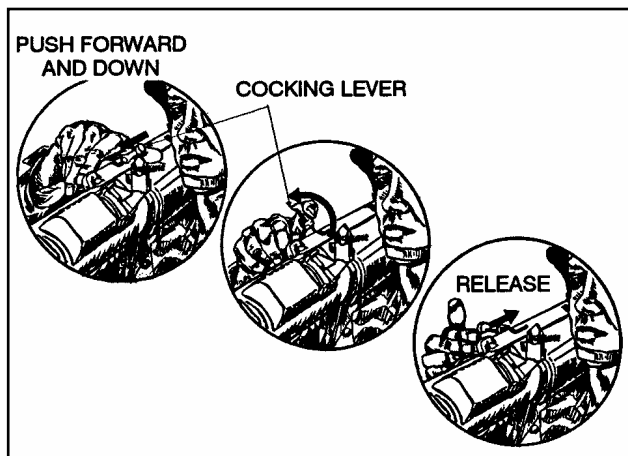

Figure 5-77. Cocking the launcher.

CAUTION

Do not refold the cocking lever. This will interfere with the function of the firing mechanism.

g. Adjust the rear sight for the required range.

(1) When closing the sight cover, the sight must be set on a range of 200 meters. Therefore, when the rear sight is uncovered, the battlesight setting is 200 meters. If the range to the target is more than 250 meters, adjust the sight to the range. When the range is 250 meters or less, no sight adjustment is required (Figure 5-78).

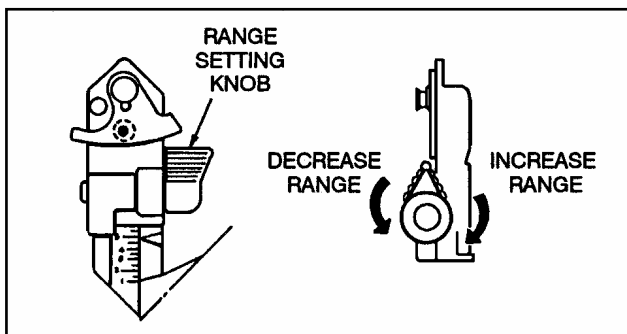

Figure 5-78. Adjusting the rear sight range setting.

(2) To adjust the rear sight range setting to more than 200 meters, turn the range knob clockwise (toward the muzzle). To decrease the range, turn the range knob counterclockwise (toward the gunner). There is a click at each 50-meter increment; this sound aids the gunner during limited visibility (Figure 5-78).

h. *Check the backblast area* before you cock the launcher. Then, with your right hand, unfold the cocking lever. Place your thumb under it and, with the support of your fingers in front of the firing mechanism, push it forward, rotate it downward and to the right, and let it slide backward.

i. Pull back on the sling with your left hand to seat the shoulder stop firmly against your shoulder. To avoid a misfire, use the index and middle fingers on your right hand to hold the forward safety down and to the left while you fire.

**PERFORM MISFIRE PROCEDURES
ON AN M136 LAUNCHER
071-054-0003**

CONDITIONS

Given an armed M136 launcher (AT4) that has misfired.

STANDARDS

Misfire procedures are applied so that the AT4 is fired, or safety mechanisms are put in place and the supervisor is informed of a misfire.

TRAINING AND EVALUATION

Training Information Outline

1. Perform misfire procedures.

a. When the launcher fails to fire, immediately shout MISFIRE.

b. Continue to hold the launcher pointed in the area of the target.

c. Release the red safety catch.

d. Immediately recock the cocking lever, check the backblast area, aim, fully depress and hold down the red safety catch, and press the red trigger button.

NOTE: If the launcher still fails to fire, repeat steps a through d above.

e. If the launcher again fails to fire, release the red safety catch and return the cocking lever to the SAFE uncocked position.

f. Remove the launcher from the shoulder while keeping the muzzle pointed toward the target area.

g. While cradling the launcher with the left arm, reinsert the transport safety pin.

NOTE: In a training situation only, after inserting the transport safety pin, wait two minutes. Keep the launcher toward the target area.

h. Carefully lay the launcher on the ground, muzzle pointed toward the target area.

2. Immediately use another launcher to engage the target.

**RESTORE AN M136 LAUNCHER
TO CARRYING CONFIGURATION
071-054-0002**

CONDITIONS

Given an M136 launcher (AT4) prepared for firing and the requirement to restore the launcher to carrying configuration.

STANDARDS

The launcher is prepared in such a manner that it is not damaged and is in a safe carrying configuration.

TRAINING AND EVALUATION

Training Information Outline

1. When the launcher is prepared for immediate firing but is not fired, it is taken out of operation as follows:

a. If the gunner is to remain in the same position—

(1) He releases the red safety catch (this step applies only if the firing sequence has proceeded to this point).

(2) He returns the cocking lever to the SAFE (uncocked) position by pushing it up and to the left, then pulling it rearward. He folds the cocking lever down.

(3) Keeping the launcher pointed at the target area, he removes the launcher from his shoulder.

(4) With the launcher cradled by his left arm, he replaces the transport safety pin.

b. If the gunner is to move to another position, in addition to the steps shown above, he must—

(1) Return the rear sight to the battlesight setting of 200 meters, fold down the front and rear sights, and close the sight covers.

CAUTION

The rear sight may be damaged if it is not returned to a battlesight setting of 200 meters before closing the sight cover.

(2) Fold the shoulder stop and snap it back into position.

2. The launcher is now in the carrying configuration and is safe and ready to transport.

SECTION IV INDIVIDUAL SKILLS

COVER, CONCEALMENT, AND CAMOUFLAGE

GENERAL

If the enemy can see you, he can hit you with his fire. So you must be concealed from enemy observation and have cover from enemy fire. When the terrain does not provide natural cover and concealment, you must prepare your cover and use natural and man-made materials to camouflage yourself, your equipment, and your position.

This chapter provides guidance on the preparation and use of cover, concealment, and camouflage.

COVER

Cover gives protection from bullets, fragments of exploding rounds, flame, nuclear effects, and biological and chemical agents. Cover can also conceal you from enemy observation. Cover can be natural or man-made. Natural cover includes such things as logs, trees, stumps, ravines, and hollows. Manmade cover includes such things as fighting positions, trenches, walls, rubble, and craters.

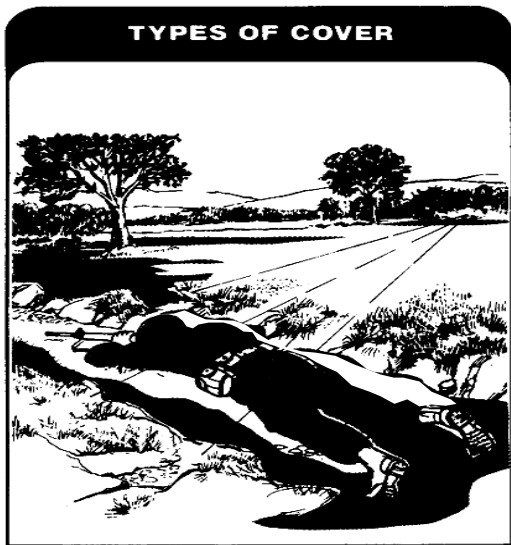

Figure 5-79

Even the smallest depression or fold in the ground can give some cover. Look for and use every bit of cover the terrain offers. In combat, you need protection from enemy direct and indirect fire. To get this protection in the defense, build a fighting position (man-made cover) to add to the natural cover afforded by the terrain.

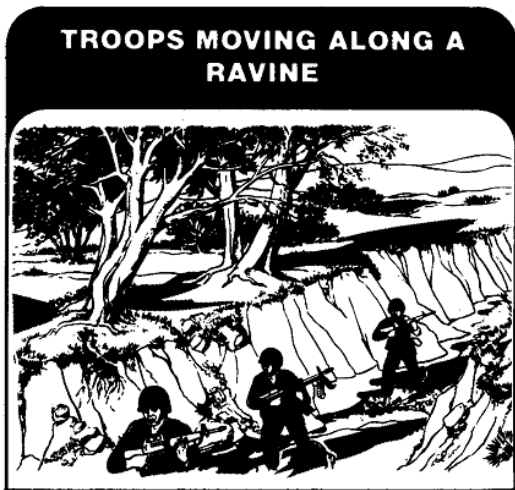

Figure 5-80

To get protection from enemy fire in the offense or when moving, use routes that put cover between you and the places where the enemy is known or thought to be. Use ravines, gullies, hills, wooded areas, walls, and other cover to keep the enemy from seeing and firing at you. Avoid open areas, and do not skyline yourself on hilltops and ridges.

CONCEALMENT

Concealment is anything that hides you from enemy observation. Concealment does not protect you from enemy fire. Do not think that you are protected from the enemy's fire just because you are concealed. Concealment, like cover, can also be natural or man-made.

Natural concealment includes such things as bushes, grass, trees, and shadows. If possible, natural concealment should not be disturbed. Man-made concealment includes such things as battle-dress uniforms, camouflage nets, face paint, and natural material that has been moved from its original location. Man-made concealment must blend into the natural concealment provided by the terrain.

Light discipline, noise discipline, movement discipline, and the use of camouflage contribute to concealment. Light discipline is controlling the use of lights at night by such things as not smoking in the open, not walking around with a flashlight on, and not using vehicle headlights. Noise discipline is taking action to deflect sounds generated by your unit (such as operating equipment) away from the enemy and, when possible, using methods to communicate that do not generate sounds (arm-and-hand signals). Movement discipline is such things as not moving about fighting positions unless necessary, and not moving on routes that lack cover and concealment. In the defense, build a well-camouflaged fighting position and avoid moving about. In the offense, conceal yourself and your equipment with camouflage and move in woods or on terrain that gives concealment. Darkness cannot hide you from enemy observation in either offense or defense. The enemy's night vision

devices and other detection means let them find you in both daylight and darkness.

CAMOUFLAGE

Camouflage is anything you use to keep yourself, your equipment, and your position from looking like what they are. Both natural and man-made material can be used for camouflage. Change and improve your camouflage often. The time between changes and improvements depends on the weather and on the material used. Natural camouflage will often die, fade, or otherwise lose its effectiveness. Likewise, man-made camouflage may wear off or fade. When those things happen, you and your equipment or position may not blend with the surroundings. That may make it easy for the enemy to spot you.

CAMOUFLAGE CONSIDERATIONS

Movement draws attention. When you give arm-and-hand signals or walk about your position, your movement can be seen by the naked eye at long ranges. In the defense, stay low and move only when necessary. In the offense, move only on covered and concealed routes.

Positions must not be where the enemy expects to find them. Build positions on the side of a hill, away from road junctions or lone buildings, and in covered and concealed places. Avoid open areas.

Outlines and shadows may reveal your position or equipment to air or ground observers. Outlines and

shadows can be broken up with camouflage. When moving, stay in the shadows when possible.

Shine may also attract the enemy's attention. In the dark, it may be a light such as a burning cigarette or flashlight. In daylight, it can be reflected light from polished surfaces such as shiny mess gear, a worn helmet, a windshield, a watch crystal and band, or exposed skin. A light, or its reflection, from a position may help the enemy detect the position. To reduce shine, cover your skin with clothing and face paint. However, in a nuclear attack, darkly painted skin can absorb more thermal energy and may burn more readily than bare skin. Also, dull the surfaces of equipment and vehicles with paint, mud, or some type of camouflage material.

Shape is outline or form. The shape of a helmet is easily recognized. A human body is also easily recognized. Use camouflage and concealment to breakup shapes and blend them with their surroundings. Be careful not to overdo it.

The **colors** of your skin, uniform, and equipment may help the enemy detect you if the colors contrast with the background. For example, a green uniform will contrast with snow-covered terrain. Camouflage yourself and your equipment to blend with the surroundings.

Dispersion is the spreading of men, vehicles, and equipment over a wide area. It is usually easier for the enemy to detect soldiers when they are bunched. So, spread out. The distance between you and your fellow soldier will vary with the terrain, degree of visibility, and

enemy situation. Distances will normally be set by unit leaders or by a unit's standing operating procedure (SOP).

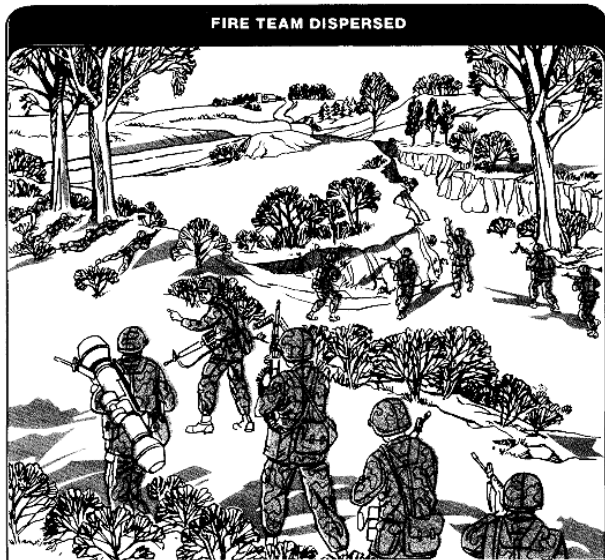

Figure 5-81

HOW TO CAMOUFLAGE

Before camouflaging, study the terrain and vegetation of the area in which you are operating. Then pick and use the camouflage material that best blends with that area. When moving from one area to another, change camouflage as needed to blend with the surroundings. Take grass, leaves, brush, and other material from your location and apply it to your uniform and equipment and put face paint on your

Before camouflaging, study the terrain and vegetation of the area in which you are operating. Then pick and use the camouflage material that best blends with that area. When moving from one area to another, change camouflage as needed to blend with the surroundings. Take grass, leaves, brush, and other material from your location and apply it to your uniform and equipment and put face paint on your skin.

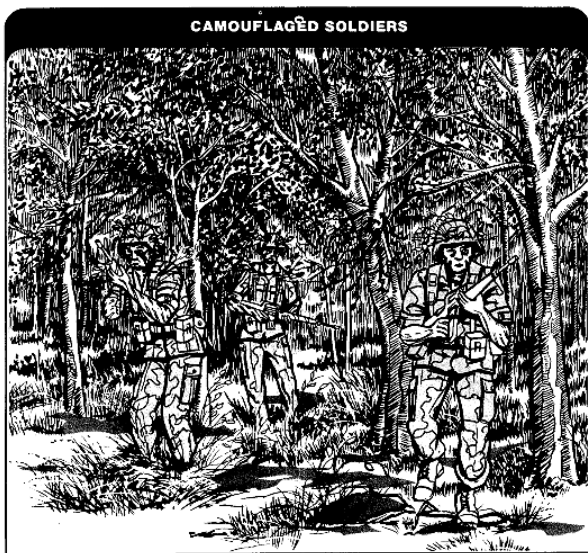

Figure 5-82

Fighting Positions. When building a fighting position, camouflage it and the dirt taken from it. Camouflage the dirt used as frontal, flank, rear, and overhead cover. Also camouflage the bottom of the hole to prevent detection

from the air. If necessary, take excess dirt away from the position (to the rear). Do not over camouflage. Too much camouflage material may actually disclose a position. Get your camouflage material from a wide area. An area stripped of all or most of its vegetation may draw attention. Do not wait until the position is complete to camouflage it. Camouflage the position as you build.

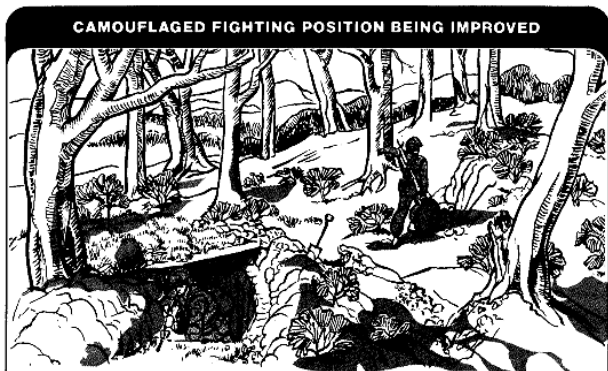

Figure 5-83

Do not leave shiny or light-colored objects lying about. Hide mess kits, mirrors, food containers, and white underwear and towels. Do not remove your shirt in the open. Your skin may shine and be seen. Never use fires where there is a chance that the flame will be seen or the smoke will be smelled by the enemy. Also, cover up tracks and other signs of movement. When camouflage is complete, inspect the position from the enemy's side. This should be done from about 35 meters forward of the position. Then check the camouflage periodically to see that it stays natural-looking and conceals the position.

When the camouflage becomes ineffective, change and improve it.

Helmets. Camouflage your helmet with the issue helmet cover or make a cover of cloth or burlap that is colored to blend with the terrain. The cover should fit loosely with the flaps folded under the helmet or left hanging. The hanging flaps may break up the helmet outline. Leaves, grass, or sticks can also be attached to the cover. Use camouflage bands, strings, burlap strips, or rubber bands to hold those in place. If there is no material for a helmet cover, disguise and dull helmet surface with irregular patterns of paint or mud.

Uniforms. Most uniforms come already camouflaged. However, it may be necessary to add more camouflage to make the uniform blend better with the surroundings. To do this, put mud on the uniform or attach leaves, grass, or small branches to it. Too much camouflage, however, may draw attention. When operating on snow-covered ground, wear overwhites (if issued) to help blend with the snow. If overwhites are not issued, use white cloth, such as white bedsheets, to get the same effect.

Skin. Exposed skin reflects light and may draw the enemy's attention. Even very dark skin, because of its natural oil, will reflect light. Use the following methods when applying camouflage face paint to camouflage the skin.

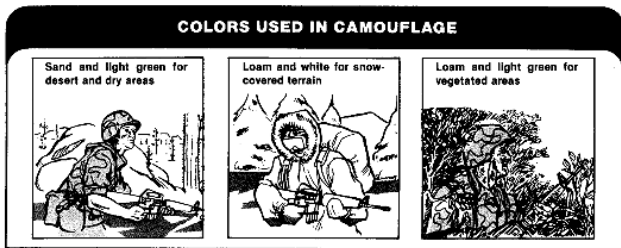

Figure 5-84

CAMOUFLAGE MATERIAL	SKIN COLOR	SHINE AREAS	SHADOW AREAS
	LIGHT OR DARK	FOREHEAD, CHEEKBONES, EARS, NOSE AND CHIN	AROUND EYES, UNDER NOSE, AND UNDER CHIN
LOAM AND LIGHT GREEN STICK	ALL TROOPS USE IN AREAS WITH GREEN VEGETATION	USE LOAM	USE LIGHT GREEN
SAND AND LIGHT GREEN STICK	ALL TROOPS USE IN AREAS LACKING GREEN VEGETATION	USE LIGHT GREEN	USE SAND
LOAM AND WHITE	ALL TROOPS USE ONLY IN SNOW-COVERED TERRAIN	USE LOAM	USE WHITE
BURNT CORK, BARK CHARCOAL, OR LAMP BLACK	ALL TROOPS, IF CAMOUFLAGE STICKS NOT AVAILABLE	USE	DO NOT USE
LIGHT-COLOR MUD	ALL TROOPS, IF CAMOUFLAGE STICKS NOT AVAILABLE	DO NOT USE	USE

Figure 5-85

When applying camouflage stick to your skin, work with a buddy (in pairs) and help each other. Apply a two-color combination of camouflage stick in an irregular pattern. Paint shiny areas (forehead, cheekbones, nose, ears, and chin) with a dark color. Paint shadow areas (around the eyes, under the nose, and under the chin) with a light color. In addition to the face, paint the exposed skin on the back of the neck, arms, and hands. Palms of hands are not normally camouflaged if arm-and-hand signals are to be used. Remove all jewelry to further reduce shine or reflection. When camouflage sticks

are not issued, use burnt cork, bark, charcoal, lamp black, or light-colored mud.

OPERATE AS A MEMBER OF A SQUAD

This section discusses formations, movement techniques, and actions during movement for infantry squads.

FIRE TEAM FORMATIONS

Formations are arrangements of elements and soldiers in relation to each other. Squads use formations for control, flexibility and security. Leaders choose formations based on their analysis of the factors of METT-T. Figure 5-86, compares formations. Leaders are up front in formations. This allows the fire team leader to lead by example, "Follow me and do as I do." All soldiers in the team must be able to see their leader.

MOVEMENT FORMATION	WHEN NORMALLY USED	CHARACTERISTICS			
		CONTROL	FLEXIBILITY	FIRE CAPABILITIES/ RESTRICTIONS	SECURITY
FIRE TEAM WEDGE	BASIC FIRE TEAM FORMATION	EASY	GOOD	ALLOWS IMMEDIATE FIRES IN ALL DIRECTIONS.	GOOD
FIRE TEAM FILE	CLOSE TERRAIN DENSE VEGETATION, LIMITED VISIBILITY CONDITIONS.	EASIEST	LESS FLEXIBLE THAN THE WEDGE.	ALLOWS IMMEDIATE FIRES TO THE FLANKS. MASK MOST FIRES TO THE REAR.	LEAST

Figure 5-86

Wedge. The wedge is the basic formation for the fire team. The interval between soldiers in the wedge formation is normally 10 meters. The wedge expands and contracts depending on the terrain. When rough terrain, poor visibility, or other factors make control of the wedge difficult, fire teams modify the wedge. The normal interval is reduced so that all team members can still see their team leader and the team leaders can still their squad leader. The sides of the wedge can contract to the point where the wedge resembles a single file. When moving in less rugged terrain, where control is easier, soldiers expand or resume their original positions. (Figure 5-87).

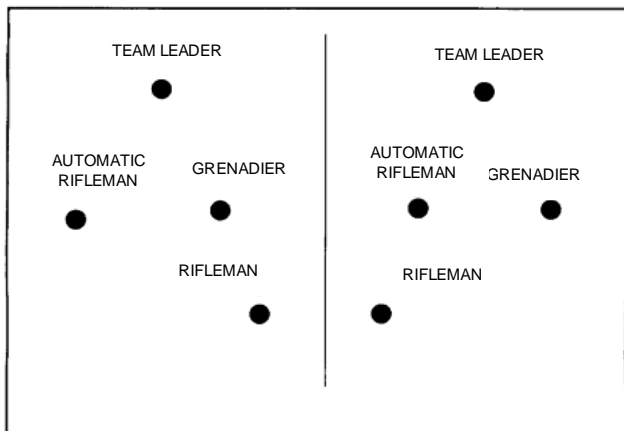

Figure 5-87

File. When the terrain precludes use of the wedge, fire teams use the file formation (Figure 5-88).

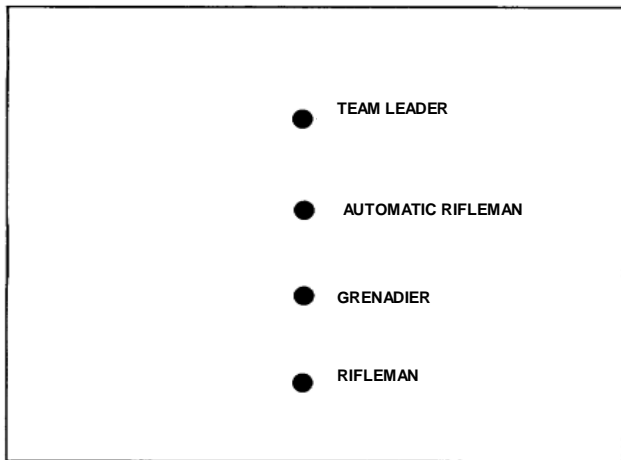

Figure 5-88

SQUAD FORMATIONS

Rifle Squad. The most common rifle squad has nine soldiers (Figure 5-89). It fights as two fire teams. The squad has one squad leader, two fire team leaders, two automatic riflemen, two riflemen, and two grenadiers

Squad formations describe the relationships between fire teams in the squad. They include the squad column and squad line. A comparison of the formations is in Figure 5-90.

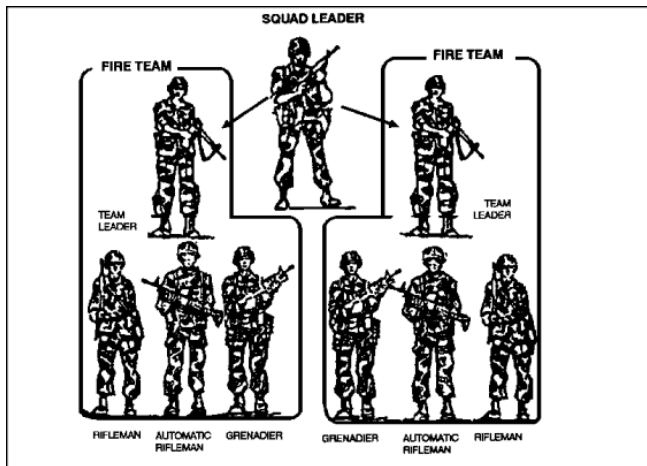

Figure 5-89. Rifle Squad.

MOVEMENT FORMATION	WHEN NORMALLY USED	CHARACTERISTICS			
		CONTROL	FLEXIBILITY	FIRE CAPABILITIES/ RESTRICTIONS	SECURITY
SQUAD COLUMN	SQUAD PRIMARY FORMATION.	GOOD	FACILITATES MANEUVER, GOOD DISPERSION Laterally AND IN DEPTH.	ALLOWS LARGE VOLUME OF FIRE TO THE FLANK— LIMITED VOLUME TO THE FRONT.	ALL-ROUND
SQUAD LINE	WHEN MAXIMUM FIRE POWER IS REQUIRED TO THE FRONT.	NOT AS GOOD AS SQUAD COLUMN.	LIMITED MANEUVER CAPABILITY (BOTH FIRE TEAMS COMMITTED).	ALLOWS MAXIMUM IMMEDIATE FIRE TO THE FRONT.	GOOD TO THE FRONT, LITTLE TO THE FLANKS AND REAR.
SQUAD FILE	CLOSE TERRAIN VEGETATION, LIMITED VISIBILITY CONDITIONS.	EASIEST	MOST DIFFICULT FORMATION FROM WHICH TO MANEUVER.	ALLOWS IMMEDIATE FIRE TO THE FLANK MASKS MOST FIRE TO THE FRONT AND REAR.	LEAST

Figure 5-90

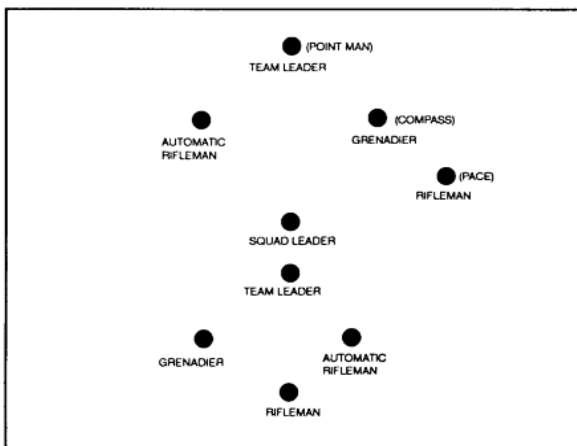

Figure 5-91

Squad Column. The squad column is the squad's most common formation. It provides good dispersion laterally and in depth without sacrificing control, and facilitates maneuver. The lead fire team is the base fire team. When the squad moves independently or as the rear element of the platoon, the rifleman in the (rail fire team provides rear security (Figure 5-91).

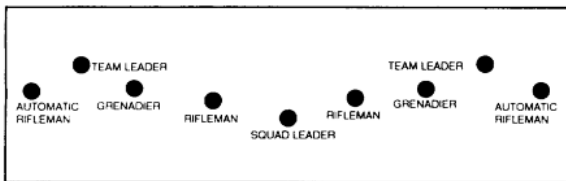

Figure 5-92

Squad Line. The squad line provides maximum firepower to the front (Figure 5-92). When a squad is acting as the base squad, the fire team on the right is the base fire team.

Squad File. When not traveling in a column or line, squads travel in file. The squad file has the same characteristics as the fire team file. If the squad leader desires to increase his control over the formation, exert greater morale presence by leading from the front, and be immediately available to make key decisions, he will move forward to the first or second position. Additional control over the rear of the formation can be provided by moving a team leader to the last position. (Figure 5-93)

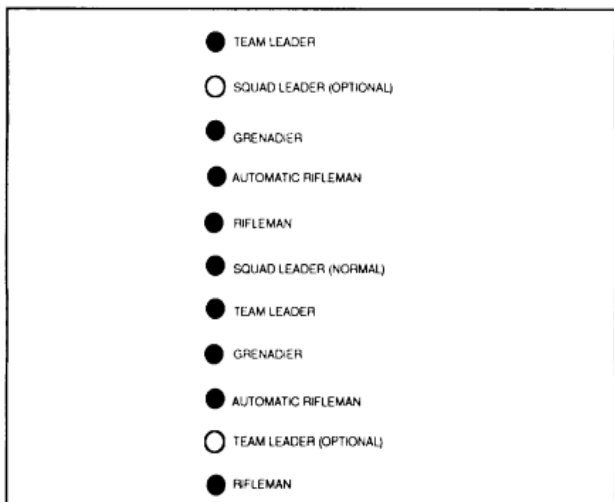

Figure 5-93

MOVEMENT TECHNIQUES

MOVEMENT TECHNIQUES	WHEN NORMALLY USED	CHARACTERISTICS			
		CONTROL	DISPERSION	SPEED	SECURITY
TRAVELING	CONTACT NOT LIKELY	MORE	LESS	FASTEST	LEAST
TRAVELING OVERWATCH	CONTACT POSSIBLE	LESS	MORE	SLOWER	MORE
BOUNDING OVERWATCH	CONTACT EXPECTED	MOST	MOST	SLOWEST	MOST

Figure 5-94

A movement technique is the manner a squad uses to traverse terrain. There are three movement techniques: traveling, traveling overwatch, and bounding overwatch. The selection of a movement technique is based on the likelihood of enemy contact and the need for speed. Factors to consider for each technique are control, dispersion, speed, and security (Figure 5-94).

Movement techniques are not fixed formations. They refer to the distances between soldiers and teams that vary based on mission, enemy, terrain, visibility, and any other factor that affects control. Soldiers must be able to see their fire team leader. The squad leader must be able to see his fire team leaders. Leaders control movement with arm-and-hand signals. They use radios only when needed. Any of the three movement techniques (traveling, traveling overwatch, bounding overwatch) can be used with any formation.

Techniques of Squad Movement. The platoon leader determines and directs which movement technique the squad will use.

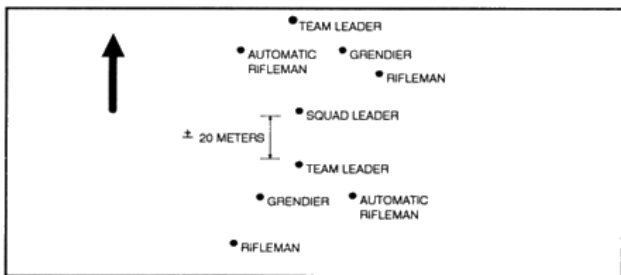

Figure 5-95

Traveling. Traveling is used when contact with the enemy is not likely and speed is needed (Figure 5-95).

Traveling overwatch. Traveling overwatch is used when contact is possible (Figure 5-96). Attached weapons move near the squad leader and under his control so he can employ them quickly.

Bounding overwatch. Bounding overwatch is used when contact is expected, when the squad leader feels the enemy is near (movement, noise, reflection, trash, fresh tracks, or even a hunch), or when a large open danger area must be crossed. The lead fire team overwatches first. Soldiers scan for enemy positions. The squad leader usually stays with the overwatch team. (Figure 5-97).

The trail fire team bounds and signals the squad leader when his team completes its bound and is prepared to overwatch the movement of the other team. Both team leaders must know if successive or alternate bounds will be used and which team the squad leader will be with.

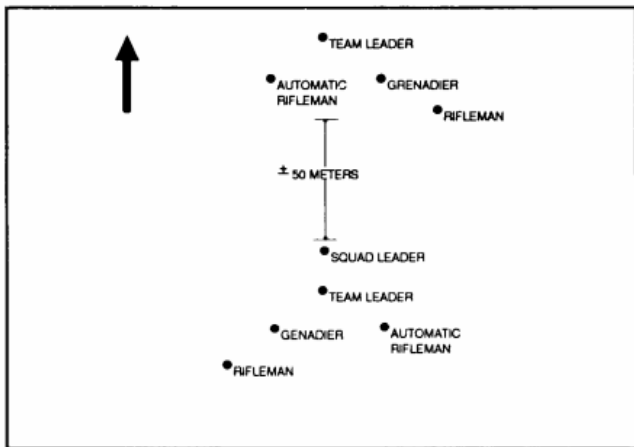

Figure 5-96

The overwatching team leader must know the route and destination of the bounding team. The bounding team leader must know his team's destination and route, possible enemy locations, and actions to take when he arrives there. He must also know where the overwatching team will be, and how he will receive his instructions. The cover and concealment on the bounding team's route dictates how its soldiers move.

Teams can bound successively or alternately. Successive bounds are easier to control; alternate bounds can be faster. (Figure 5-97)

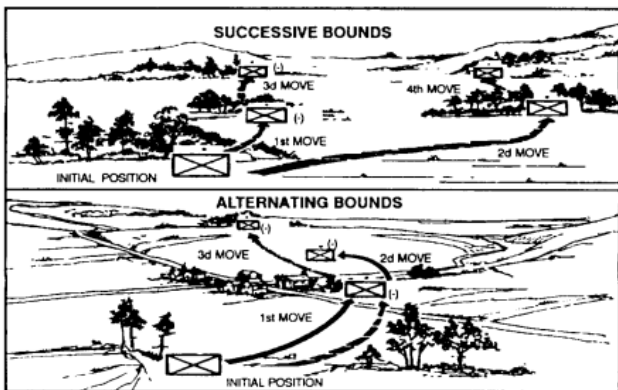

Figure 5-97

Tactical marches. Troop movement is the transporting of troops from one place to another by any available means. This is inherent in all military operations. A successful move places troops and equipment at their destination at the proper time ready for combat. Troop movement is conducted by foot or motor marches, by rail, by air, or by water, or by various combinations of these methods.

Foot marches. Many examples of successful marches exist throughout the history of warfare. A good example of a successful march occurred during World War II. It was the grueling foot march during the Sicilian campaign from 20 to 21 July 1943. The 3d Battalion, 30th Infantry Regiment, 3d Infantry Division performed this march. The battalion was directed to move on foot across mountains from Aragona to San Stefano to enter into a coordinated attack on enemy forces in San Stefano. The battalion made

this record-breaking, 54-mile, cross-country march in only 33 hours due to continuous marching. Two hours after arrival, the battalion was committed in the attack on San Stefano, which resulted in its capture.

A second example was the movement of large elements of the 3d US Army during the battle of Ardennes in 1944 to stop the enemy counteroffensive. On 16 December 1944, while the 3d US Army was preparing to attack the Siegfried line in Germany, the Battle of the Bulge commenced. By 19 December, the German attack had reached such large proportions that the 3d US Army was directed to cease its attack to the east and to turn north. The 3d US Army shifted its troops from the Saarlautern-Saarbrücken area to the Luxemburg-Belgium area, a distance of 100-road miles. The III Corps launched the new attack at 0600 on 22 December 1944.

Considerations for Conducting a Foot March

March Discipline - March discipline includes observing and enforcing the rules and instructions that govern a unit on a march, which include formation, distances between elements, speed, and the effective use of concealment and cover. It must also include specific controls and restrictions such as water, light, noise, and disciplines. March discipline is the culmination of effective training, which results in enthusiastic teamwork among all soldiers of the unit.

1. **Water Discipline** - Water discipline must be observed by all unit members to ensure best health and marching efficiency. The following rules must be adhered to:

- a Drink plenty of water before each march to aid sustainment during movement.
- b Drink only treated water from approved sources.
- c Drink water often. Water should be consumed before, during, and after the march.
- d Drink small quantities of water rather than gulping or rapid intake.
- e Drink water even when not thirsty.
- f Drink water slowly to prevent cramps or nausea.
- g Avoid spilling water.
- h Refill canteens at every opportunity.

1.) The human body does not operate efficiently without adequate liquid intake. When soldiers are engaged in strenuous activities, excessive amounts of water and electrolytes are lost through perspiration. More water is lost through normal body functions such as respiration and urination, which can create a liquid imbalance in the body. As a result, dehydration could occur unless this loss is immediately replaced and soldiers rest before continuing their activities. Deficient liquid and salt intake during hot weather can also result in heat injuries.

2.) The danger of dehydration is as prevalent in cold regions as it is in hot, dry areas. The difference is that in hot weather the soldier is aware that his body loses liquids and salt through perspiration. In cold weather, when a

soldier is bundled up in many layers of clothing, he has difficulty knowing this condition exists since perspiration is rapidly absorbed by heavy clothing or evaporated by the air--it is rarely visible on the skin.

3.) Salt in food compensates for the daily salt requirement. Additional intake of salt should be under the direction and supervision of a physician or physician's assistant.

4.) If pure water is not available, water in canteens can be treated by adding water purification tablets. (*See FM 21-10 for methods of purifying water.*)

5.) If the unit is forced to traverse a contaminated area (NBC) due to the tactical situation, water consumption increases and forced hydration becomes necessary. Leaders at all levels must try to prevent heat injuries brought on by physical activity in an NBC environment.

2. Foot Care - Foot hygiene and sanitation are extremely important since feet are enclosed in heavy rigid footwear during most working hours and are constantly in action. Foot care involves good hygiene measures such as bathing frequently, using foot powder, wearing properly fitted footwear to allow for ventilation, and correctly trimming toenails.

- a. Foot Hygiene - The care of minor foot ailments should be given the utmost attention. Many major conditions requiring hospitalization and disability have resulted from neglected or maltreated minor conditions.

- b. Conditioning - Conditioning is accomplished by progressively increasing the distance to be marched from day to day. Marching is a good way to strengthen the feet and legs; running alone will not suffice. The arch, ankle, and calf can be conditioned by performing simple exercises--for example, rising high on the toes or placing the feet on towels and using the toes to roll the towel back under the arch.
- c. Preventive Measures - Certain preventive measures can be implemented to avoid painful foot problems.
 - 1) Before Marches. Trim toenails at least every two or three weeks, depending upon individual needs. Cut toenails short and square, and straight across (Figure C-1). Keep feet clean and dry, and use foot powder. Wear clean, dry, unmended, good-fitting socks (preferably cushion-soled) with seams and knots outside. A nylon or polypropylene sock liner can reduce friction and add protection. Carry an extra pair of socks. Carefully fit new boots. When getting used to a new pair of boots, alternate with another pair; tape known hot spots before wearing.
 - 2) During Halts. Lie down with the feet elevated during each halt. If time permits, massage the feet, apply foot powder, change socks, and medicate blisters. Cover open blisters, cuts, or abrasions with absorbent adhesive bandages. Obtain relief from swelling feet by slightly loosening bootlaces where they cross the arch of the foot.
 - 3) After Marches. Repeat procedures for the care of feet, wash and dry socks, and dry boots. Medicate blisters,

abrasions, corns, and calluses. Inspect painful feet for sprains and improper fitting of socks and boots. Feet can develop red, swollen, tender skin along the sides of the feet from prolonged marching, which could become blisters. Therefore, feet require aeration, elevation, rest, and wider footwear. Prevent major foot problems by keeping the feet clean. The formation of blisters and abrasions with dirt and perspiration can cause infection and serious injury. If possible, give the feet a daily foot bath. In the field, cool water seems to reduce the sensation of heat and irritation. After washing, dry the feet well.

- d. Foot Injuries - Many foot injuries can occur from foot marches, but only the most common are discussed herein.
- 1) Blisters And Abrasions - Common causes of blisters and abrasions are improperly conditioned feet, ill-fitting footwear and socks, improperly maintained footwear, heat, and moisture. They are normally caused by friction or pressure, as opposed to impact. To clean a blister, wash gently around it with soap and water, being careful not to break the skin. If unbroken, use a sterilized needle or knifepoint to prick the lower edge of the blister to remove fluid. (To sterilize needle or knifepoint, hold in a flame.) Do not remove the skin; cover the blister with an absorbent adhesive bandage or similar dressing, extending beyond the edge of the blister. After applying the dressing, dust the outside of the dressing and entire foot with foot powder. Use just enough foot powder since it can harden and become irritating. Foot powder lessens friction on the skin and prevents the

raw edges of the adhesive plaster from adhering to socks. The adhesive plaster should be smooth so it can serve as a "second skin." Check the blister periodically for proper drying. After the blister has dried, remove the adhesive plaster. Carefully inspect the foot for other problem areas that are red and tender that may need the protection of an adhesive plaster. Cover abrasions and cuts on the foot with absorbent adhesive bandages for rapid healing. In an emergency, medical personnel can inject tincture of benzoin into a blister to prevent further abrasion and loss of skin.

- 2) Perspiration Problems - When feet perspire, the secretion decomposes and causes a foul odor. The skin between the toes usually becomes white and soft, rubs off easily, and is prone to abrasions. Treatment consists of washing and thoroughly drying the feet, and carefully painting the affected area with a cotton swab and the following solution: Formalin --one part, Rubbing alcohol--nine parts. This solution should be allowed to dry. If the skin begins to burn, the excess solution should be washed off. It should be kept out of abrasions and cuts since it can cause severe pain. The entire area of the foot to include the ankle is painted. The areas around the heel and instep, and between toes should be treated since they are main trouble spots. The solution should be applied once daily until the perspiration is halted and the skin becomes hardened.
- 3) Athlete's Foot - Athlete's foot usually occurs between the toes, on the sole of the foot, and at points of contact between skin and footwear. This and other

mild chronic cases of fungus infection may respond to daily foot powder applications. If fungicidal ointment is available, it can be used in addition to foot powder. Ointment should be used as directed and while the feet are at rest. If applications of foot powder and ointment do not heal the infection, an aidman or surgeon should be consulted.

- 4) Frostbite - Frostbite is the freezing of a body part due to exposure to below-freezing temperatures, and it is classified as either superficial or deep. It is a constant hazard in operations performed at freezing temperatures, mainly when accompanied with strong winds. Normally, a cold sensation occurs that is followed by numbness and then a tingling, stinging, or aching, or even a cramping pain. The skin first turns red and then yellowish, pale gray, or waxy white. Prevention of frostbite, or stopping it in its early stages, is easier than thawing and caring for frozen flesh. Good-fitting clothing and properly worn equipment avoid interference with blood circulation, which could reduce the amount of heat delivered to the extremities. To prevent severe frostbite—
 - a) Enough clothing must be worn for protection against cold and wind. The face must be protected during high winds and during exposure to aircraft propeller blast.
 - b) Clothing and the body must be kept dry. To avoid perspiring when performing heavy work in the cold, soldiers should remove outer layers of clothing and then replace them when work is finished. Socks should be changed when the feet become moist.

c) Cold metal should not be touched with the bare skin in extremely low temperatures. To do so could mean loss of skin.

d) Adequate clothing and shelter must be provided during inactive times.

e) The face, fingers, toes, and ears should be exercised or massaged to keep them warm and to detect any numb or hard areas.

f) The buddy system should always be used. Soldiers should find partners and observe each other for signs of frostbite and for mutual aid if frostbite occurs. Any small frozen spots should be thawed immediately, using bare hands or other sources of body heat.

g) Some cases of frostbite may be superficial, which involves only the skin. If freezing extends below the skin, it demands more involved treatment to avoid or lessen the loss of the body part (fingers, toes, hands, or feet). Often there is no pain, so soldiers must observe each other for signs. Since it is difficult to distinguish between superficial and deep frostbite, a soldier should assume the injury to be deep and therefore serious. If numbness has been for a short time, the frostbite is probably superficial.

h) For treatment of superficial frostbite, the following measures must be adhered to:

- (1) Cover cheeks with warm hands until the pain returns.

- (2) Place bared frostbitten feet under clothing and against the chest of a companion.
- (3) Do not rewarm by such measures as massage, exposure to open fires, cold-water soaks, or rubbing with snow.
- (4) Place uncovered frostbitten fingers under the opposing armpits next to the skin.
- (5) Be prepared for pain when thawing occurs.
 - i) For treatment of deep frostbite (freezing injury), the following measures must be adhered to:

- (1) If freezing is considered deep, do not attempt to treat the injury in the field. This only causes increased pain and invites infection, greater damage, and even gangrene. Quickly evacuate injured personnel to a hospital or aid station.
- (2) Protect the frozen body part from further injury and do not try to thaw it by rubbing, bending, or massaging
- (3) Do not rub body part with snow or place in cold or warm water; do not expose to hot air or open fires; and do not use ointments or poultices.
- (4) Soldiers should not walk on feet after thawing; it is safer to walk on frozen feet. However, thawing may occur spontaneously during transporting to a medical facility. This cannot be avoided since the entire body of the injured soldier must be kept warm.

j) Soldiers who have sustained any form of cold injury are more susceptible to a reoccurrence.

1) Trenchfoot - Trenchfoot is a thermal injury due to exposure to severe cold-weather conditions in a damp or wet environment in temperatures between 32 and 50 degrees F. Contributing causes include immobility of the limbs as in sitting or standing, insufficient clothing, and constriction of body parts due to boots, socks, and other garments. Trenchfoot is similar to gradual frostbite since the primary causes are the same. The only difference is in the degree of cold. In the early stages of trenchfoot, feet and toes are pale, and they feel cold, numb, and stiff. Walking becomes labored. If preventive action is not taken at this stage, the feet will swell and become painful. In extreme cases of trenchfoot, the flesh dies and amputation of the foot or leg may be needed. Because the early stages of trenchfoot are not painful, soldiers must be alert to prevent it.

- a) Socks and boots should be cleaned and dried daily, and feet should be dried soon after being wet. If soldiers must wear wet boots and socks, the feet should be exercised by wiggling the toes and bending the ankles, and they should be warmed with the hands. Then foot powder should be applied and dry socks put on.
- b) In treating trenchfoot, the feet should be handled gently; they should not be rubbed or massaged. If needed, feet can be cleaned carefully with plain white soap and water, dried, elevated, and left exposed. While it is best to warm the patient, the feet should

always be at room temperature. The patient should be carried and not allowed to walk on damaged feet.

2) Immersion Foot - Immersion foot is a form of injury that follows prolonged immersion of the feet in water that is not cold enough to cause freezing or frostbite. It can occur after exposure in subtropical waters. Clinically and pathologically, immersion foot is like trenchfoot since its cause is the same--lowering the temperature of the body part involved. It is associated with dependency (legs and feet down as in sitting or standing) and immobility of the lower extremities, and with constriction of the limbs by clothing or shoes. Other important factors are: body cooling due to wind, total immersion, inadequate protective clothing, illness, and starvation. The treatment for immersion foot is the same as for trenchfoot.

3) Stress Fractures And Muscle Injuries - Once stress fractures have occurred, they must be allowed time to heal. The affected area must rest for two or three weeks until the pain is gone, followed by a slow return to activity to avoid recurring injury. Personnel who have had an injury are more likely to be injured again. The best form of treatment for this type injury is prevention. This can be accomplished through a conditioning program and by ensuring major muscle groups are properly stretched and warmed up before marching.

3. Care of Footwear - Boots must be dried after use to avoid losing shape and hardening of the leather. This can be done by placing a warm cloth in the boot or by any method that avoids rapid drying. To prevent moist leather from freezing during winter, boots should be placed inside a sleeping bag or used as a headrest.

a. Boots - Two important factors in fitting boots are: the space between the end of the great toe and the toe of the boot should be the width of the thumb; and, in the unlaced boot, there should be enough space under the lower edge of the tongue to insert an index finger

1.) Poorly fitted boots can cause blisters, abrasions, calluses, and corns. Pressure is caused by boots being too small; friction is caused by boots being too large. If the tops of the toes are involved, the cap is too low or too stiff. If the ends of the toes are affected, the boot is too short or too loosely laced. If the sides of the big and little toes become irritated, the boot is too narrow. Irritation at the heel is caused by boots being too long, too loosely laced, or too wide a heel space.

2.) Proper lacing of boots not only prevents blisters but also prevents improper blood flow in the foot. Laces can assume a seesaw action, which can produce a long blister across the instep. To prevent blistering, lacing over the instep can be avoided. If possible, broad laces should be used and an extra pair should be carried.

b. Socks - To check the fit of socks, a soldier should stand with his weight evenly distributed on both feet. If the socks fit correctly, no tightness or fullness should exist. The wool cushion-sole sock is best because it offers good foot protection. Soldiers should allow $\frac{3}{8}$ of an inch for shrinkage of new socks. Those that are too large wrinkle inside the shoe, rub the feet, and cause blisters and abrasions. Socks that are too small wear quickly and reduce blood flow in the foot. When wearing two pairs of socks, soldiers should wear an outer pair at least a half-size larger than usual. Socks must be changed daily-- dirty

socks are conductors of heat and allow warmth to escape. They should be washed in lukewarm water to preserve the fiber of the sock since hot water can cause them to shrink. When socks become damp, they can be dried by placing them inside a shirt next to the body. Socks should be completely dry before wearing. If it is not possible to wash the socks, they should be changed; the dirty socks should be dried and kneaded with the hands to remove dirt and hardness.

FIGHTING POSITIONS

This paragraph discusses techniques for the construction of infantry fighting positions. Infantrymen use hasty; one-, two-, and three-soldier; machine gun; medium and light antitank; and 90-mm recoilless rifle positions. Soldiers must construct fighting positions that protect them and allow them to fire into their assigned sectors.

Protection. Fighting positions protect soldiers by providing **cover** through sturdy construction, and by providing **concealment** through positioning and proper camouflage. The enemy must not be able to identify the position until it is too late and he has been effectively engaged. When possible, soldiers should site positions in nonobvious places, behind natural cover, and in an easy to camouflage location. **The most important step in preparing fighting position is to make sure that it cannot be seen.** In constructing fighting positions, soldiers should always--

- a Dig the positions armpit deep.
- b Fill sandbags about 75 percent full.

- c Revet excavations in sandy soil.
- d Check stabilization of wall bases.
- e Inspect and test the position daily, after heavy rain, and after receiving direct or indirect fires.
- f Maintain, repair, and improve positions as required.
- g Use proper materiel. Use it correctly.

Siting to Engage the Enemy. Soldiers must be able to engage the enemy within their assigned sectors of fire. They should be able to fire out to the maximum effective range of their weapons with maximum grazing fire and minimal dead space. Soldiers and leaders must be able to identify the best location for their positions that meet this criteria. Leaders must also ensure that fighting positions provide interlocking fires. This allows them to cover the platoon's sector from multiple positions and provides a basis for final protective fires.

Prepare by Stages. Leaders must ensure that their soldiers understand when and how to prepare fighting positions based on the situation. Soldiers normally prepare hasty fighting positions every time the platoon halts (except for short security halts), and only half of the platoon digs in while the other half maintains security. Soldiers prepare positions in stages and require a leader to inspect the position before moving on to the next stage. See the following example.

STAGE 1. The leader checks the fields of fire from the prone position and has the soldier emplace sector stakes (Figure 5-98).

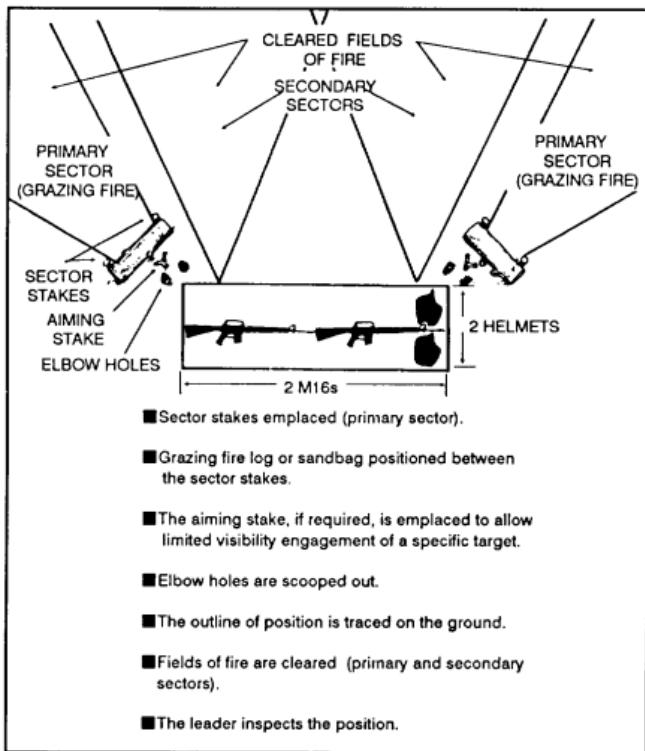

Figure 5-98

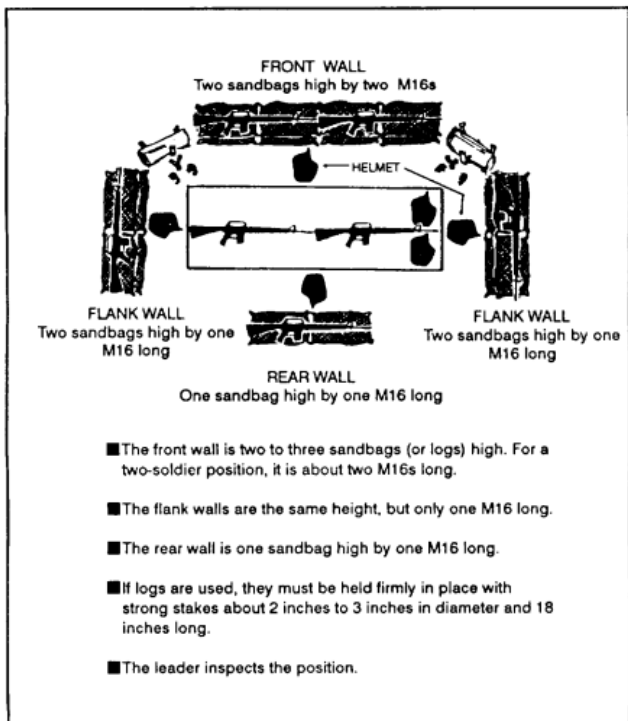

Figure 5-99

STAGE 2. The retaining walls for the parapets are prepared at this stage. These ensure that there is at least one helmet distance from the edge of the hole to the beginning of the front, flank, and rear cover (Figure 5-99).

STAGE 3. During stage 3, the position is dug and the dirt is thrown forward of the parapet retaining walls and then packed down hard (Figure 5-100).

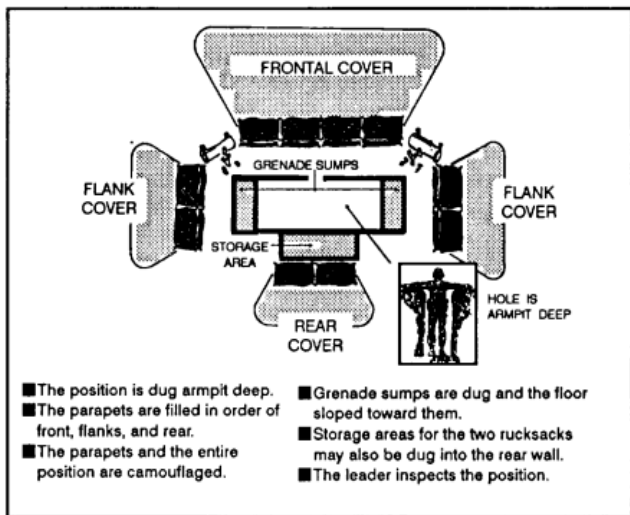

Figure 5-100

STAGE 4. The overhead cover is prepared (Figure 5-101). Camouflage should blend with surrounding terrain. At a distance of 35 meters, the position should not be detectable.

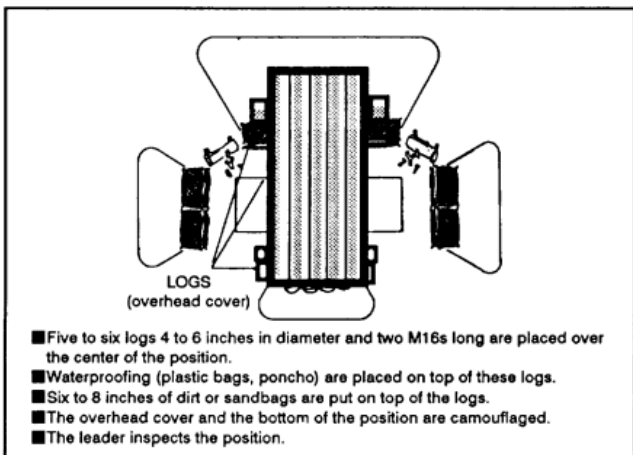

Figure 5-101

Types of Fighting Positions. There are many different types of fighting positions. The number of personnel, types of weapons, the time available, and the terrain are the main factors that dictate the type of position.

Hasty fighting position. Soldiers prepare this type of position when there is little or no time to prepare fighting positions (Figure 5-102). They locate it behind whatever cover is available. It should give frontal protection from direct fire while allowing fire to the front and oblique. A hasty position may consist simply of a rucksack placed beside a tree or large rock. For protection from indirect fire, a hasty fighting position should be in a small depression or hole at least 18 inches deep. The term hasty position does not mean there is no digging. Even if there

are only a few minutes, a prone shelter can be scraped out or dug to provide some protection. This type of position is well suited for ambushes or for protection of an overwatching element during raids and attacks. Hasty positions can also be the first step in construction of more elaborate positions.



Figure 5-102. Hasty Fighting Position

One-soldier fighting position. This type of position allows choices in the use of cover; the hole only needs to be large enough for one soldier and his gear. It does not have the security of a two-soldier position. The one-soldier fighting position must allow a soldier to fire to the front or to the oblique from behind frontal cover. (Figure 5-103.)



Figure 5-103. One Man Fighting Position

Two-soldier fighting position. A two-soldier fighting position can be prepared in close terrain. It can be used where grazing fire and mutual support extend no farther than to an adjacent position. It can be used to cover dead space just in front of the position. One or both ends of the hole are extended around the sides of the frontal cover. Changing a hole this way lets both soldiers see better and have greater sectors of fire to the front. Also, during rest or eating periods, one soldier can watch the entire sector while the other sleeps or eats. If they receive fire from their front, they can move back to gain the protection of the frontal cover. By moving about 1 meter, the soldiers can continue to find and hit targets to the front during lulls

in enemy fire. This type of position requires more digging and is harder to camouflage. It is also a better target for enemy hand grenades (Figure 5-104.)



Figure 5-104. Two-Soldier Fighting Position

BAYONET/COMBATIVES FIGHTING

Hand-to-hand combat is an engagement between two or more persons in an empty-handed struggle or with handheld weapons such as knives, sticks, and rifles with bayonets. These fighting arts are essential military skills. Projectile weapons may be lost or broken, or they may fail to fire. When friendly and enemy forces become so intermingled that firearms and grenades are not practical, hand-to-hand combat skills become vital assets.

PURPOSE OF COMBATIVES TRAINING

Today's battlefield scenarios may require silent elimination of the enemy. Unarmed combat and expedient-weapons training should not be limited to forward units. With rapid mechanized/motorized, airborne, and air assault abilities, units throughout the battle area could be faced with close-quarter or unarmed fighting situations. With low-intensity conflict scenarios and guerrilla warfare conditions, any soldier is apt to face an unarmed confrontation with the enemy, and hand-to-hand combative training can save lives. The many practical battlefield benefits of combative training are not its only advantage. It can also contribute to individual and unit strength, flexibility, balance, and cardiorespiratory fitness and build courage, confidence, self-discipline, and esprit de corps.

BASIC PRINCIPLES

There are basic principles that the hand-to-hand fighter must know and apply to successfully defeat an opponent. The principles mentioned are only a few of the basic guidelines that are essential knowledge for hand-to-hand combat. There are many others, which through years of study become intuitive to a highly skilled fighter.

Physical Balance. Balance refers to the ability to maintain equilibrium and to remain in a stable, upright position. A hand-to-hand fighter must maintain his balance both to defend himself and to launch an effective attack. Without balance, the fighter has no stability with which to defend himself, nor does he have a base of power for an attack. The fighter must understand two aspects of balance in a struggle:

1. **How to move his body to keep or regain his own balance.** A fighter develops balance through experience, but usually he keeps his feet about shoulder-width apart and his knees flexed. He lowers his center of gravity to increase stability.

2. **How to exploit weaknesses in his opponent's balance.** Experience also gives the hand-to-hand fighter a sense of how to move his body in a fight to maintain his balance while exposing the enemy's weak points.

Mental Balance. The successful fighter must also maintain a mental balance. He must not allow fear or anger to overcome his ability to concentrate or to react instinctively in hand-to-hand combat.

Position. Position refers to the location of the fighter (defender) in relation to his opponent. A vital principle when being attacked is for the defender to move his body to a safe position--that is, where the attack cannot continue unless the enemy moves his whole body. To position for a counterattack, a fighter should move his whole body off the opponent's line of attack. Then, the opponent has to change his position to continue the attack. It is usually safe to move off the line of attack at a 45-degree angle, either toward the opponent or away from him, whichever is appropriate. This position affords the fighter safety and allows him to exploit weaknesses in the enemy's counterattack position. Movement to an advantageous position requires accurate timing and distance perception.

Timing. A fighter must be able to perceive the best time to move to an advantageous position in an attack. If he moves too soon, the enemy will anticipate his movement and adjust the attack. If the fighter moves too late, the enemy will strike him. Similarly, the fighter must launch his attack or counterattack at the critical instant when the opponent is the most vulnerable.

Distance. Distance is the relative distance between the positions of opponents. A fighter positions himself where distance is to his advantage. The hand-to-hand fighter must adjust his distance by changing position and developing attacks or counterattacks. He does this according to the range at which he and his opponent are engaged.

Momentum. Momentum is the tendency of a body in motion to continue in the direction of motion unless acted on by another force. Body mass in motion develops momentum. The greater the body mass or speed of movement, the greater the momentum. Therefore, a fighter must understand the effects of this principle and apply it to his advantage.

1. The fighter can use his opponent's momentum to his advantage--that is, he can place the opponent in a vulnerable position by using his momentum against him.

2. The opponent's balance can be taken away by using his own momentum.

3. The opponent can be forced to extend farther than he expected, causing him to stop and change his direction of motion to continue his attack.

4. An opponent's momentum can be used to add power to a fighter's own attack or counterattack by combining body masses in motion.

5. The fighter must be aware that the enemy can also take advantage of the principle of momentum. Therefore, the fighter must avoid placing himself in an awkward or vulnerable position, and he must not allow himself to extend too far.

Leverage. A fighter uses leverage in hand-to-hand combat by using the natural movement of his body to place his opponent in a position of unnatural movement. The fighter uses his body or parts of his body to create a natural mechanical advantage over parts of the enemy's body. He should never oppose the enemy in a direct test of strength; however, by using leverage, he can defeat a larger or stronger opponent.

VITAL TARGETS

The body is divided into three sections: high, middle, and low. Each section contains vital targets (Figure 5-105). The effects of striking these targets follow:

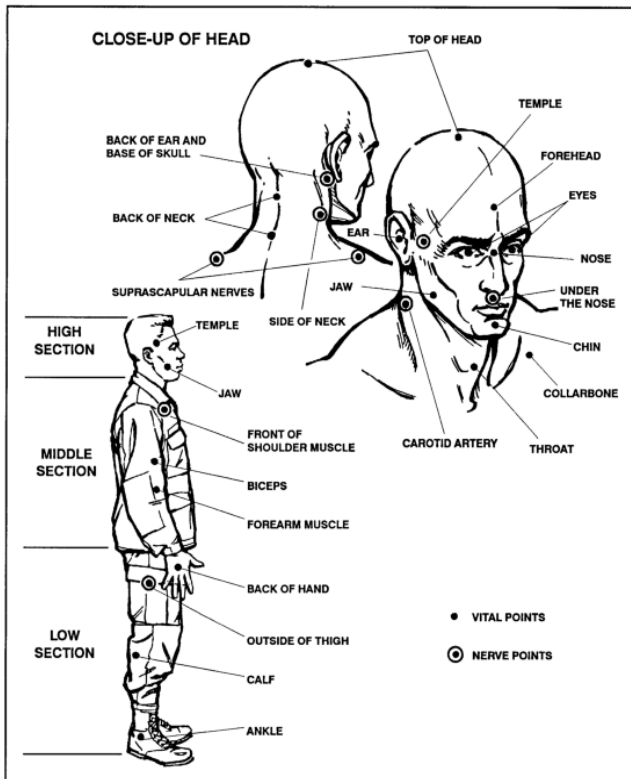

Figure 5-105

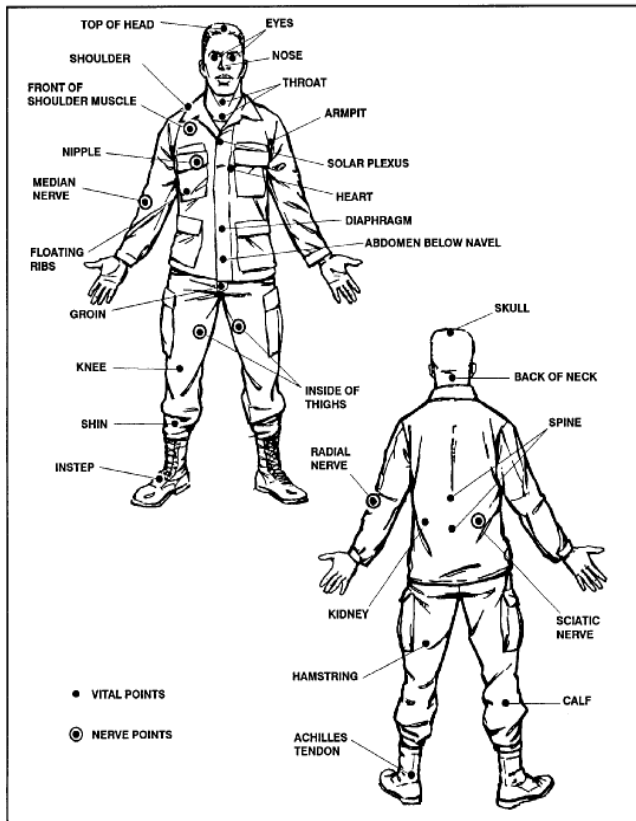

Figure 5-105 (continued)

a. **High Section.** The high section includes the head and neck; it is the most dangerous target area.

(1) **Top of the head.** The skull is weak where the frontal cranial bones join. A forceful strike causes

trauma to the cranial cavity, resulting in unconsciousness and hemorrhage. A severe strike can result in death.

(2) **Forehead.** A forceful blow can cause whiplash; a severe blow can cause cerebral hemorrhage and death.

(3) **Temple.** The bones of the skull are weak at the temple, and an artery and large nerve lie close to the skin. A powerful strike can cause unconsciousness and brain concussion. If the artery is severed, the resulting massive hemorrhage compresses the brain, causing coma and or death.

(4) **Eyes.** A slight jab in the eyes causes uncontrollable watering and blurred vision. A forceful jab or poke can cause temporary blindness, or the eyes can be gouged out. Death can result if the fingers penetrate through the thin bone behind the eyes and into the brain.

(5) **Ears.** A strike to the ear with cupped hands can rupture the eardrum and may cause a brain concussion.

(6) **Nose.** Any blow can easily break the thin bones of the nose, causing extreme pain and eye watering.

(7) **Under the nose.** A blow to the nerve center, which is close to the surface under the nose, can cause great pain and watery eyes.

(8) **Jaw.** A blow to the jaw can break or dislocate it. If the facial nerve is pinched against the lower jaw, one side of the face will be paralyzed.

(9) **Chin.** A blow to the chin can cause paralysis, mild concussion, and unconsciousness. The jawbone acts as a lever that can transmit the force of a blow to the back of the brain where the cardiac and respiratory mechanisms are controlled.

(10) **Back of ears and base of skull.** A moderate blow to the back of the ears or the base of the skull can cause unconsciousness by the jarring effect on the back of the brain. However, a powerful blow can cause a concussion or brain hemorrhage and death.

(11) **Throat.** A powerful blow to the front of the throat can cause death by crushing the windpipe. A forceful blow causes extreme pain and gagging or vomiting.

(12) **Side of neck.** A sharp blow to the side of the neck causes unconsciousness by shock to the carotid artery, jugular vein, and vagus nerve. For maximum effect, the blow should be focused below and slightly in front of the ear. A less powerful blow causes involuntary muscle spasms and intense pain. The side of the neck is one of the best targets to use to drop an opponent immediately or to disable him temporarily to finish him later.

(13) ***Back of neck.*** A powerful blow to the back of one's neck can cause whiplash, concussion, or even a broken neck and death.

b. **Middle Section.** The middle section extends from the shoulders to the area just above the hips. Most blows to vital points in this region are not fatal but can have serious, long-term complications that range from trauma to internal organs to spinal cord injuries.

(1) ***Front of shoulder muscle.*** A large bundle of nerves passes in front of the shoulder joint. A forceful blow causes extreme pain and can make the whole arm ineffective if the nerves are struck just right.

(2) ***Collarbone.*** A blow to the collarbone can fracture it, causing intense pain and rendering the arm on the side of the fracture ineffective. The fracture can also sever the brachial nerve or subclavian artery.

(3) ***Armpit.*** A large nerve lies close to the skin in each armpit. A blow to this nerve causes severe pain and partial paralysis. A knife inserted into the armpit is fatal as it severs a major artery leading from the heart.

(4) ***Spine.*** A blow to the spinal column can sever the spinal cord, resulting in paralysis or in death.

(5) ***Nipples.*** A large network of nerves passes near the skin at the nipples. A blow here can

cause extreme pain and hemorrhage to the many blood vessels beneath.

(6) **Heart.** A jolting blow to the heart can stun the opponent and allow time for follow-up or finishing techniques.

(7) **Solar plexus.** The solar plexus is a center for nerves that control the cardiorespiratory system. A blow to this location is painful and can take the breath from the opponent. A powerful blow causes unconsciousness by shock to the nerve center. A penetrating blow can also damage internal organs.

(8) **Diaphragm.** A blow to the lower front of the ribs can cause the diaphragm and the other muscles that control breathing to relax. This causes loss of breath and can result in unconsciousness due to respiratory failure.

(9) **Floating ribs.** A blow to the floating ribs can easily fracture them because they are not attached to the rib cage. Fractured ribs on the right side can cause internal injury to the liver; fractured ribs on either side can possibly puncture or collapse a lung.

(10) **Kidneys.** A powerful blow to the kidneys can induce shock and can possibly cause internal injury to these organs. A stab to the kidneys induces instant shock and can cause death from severe internal bleeding.

(11) ***Abdomen below navel.*** A powerful blow to the area below the navel and above the groin can cause shock, unconsciousness, and internal bleeding.

(12) ***Biceps.*** A strike to the biceps is most painful and renders the arm ineffective. The biceps is an especially good target when an opponent holds a weapon.

(13) ***Forearm muscle.*** The radial nerve, which controls much of the movement in the hand, passes over the forearm bone just below the elbow. A strike to the radial nerve renders the hand and arm ineffective. An opponent can be disarmed by a strike to the forearm; if the strike is powerful enough, he can be knocked unconscious.

(14) ***Back of hand.*** The backs of the hands are sensitive. Since the nerves pass over the bones in the hand, a strike to this area is intensely painful. The small bones on the back of the hand are easily broken and such a strike can also render the hand ineffective.

c. Low Section. The low section of the body includes everything from the groin area to the feet. Strikes to these areas are seldom fatal, but they can be incapacitating.

(1) ***Groin.*** A moderate blow to the groin can incapacitate an opponent and cause intense pain. A powerful blow can result in unconsciousness and shock.

(2) ***Outside of thigh.*** A large nerve passes near the surface on the outside of the thigh about four finger-widths above the knee. A powerful strike to this region can render the entire leg ineffective, causing an opponent to drop. This target is especially suitable for knee strikes and shin kicks.

(3) ***Inside of thigh.*** A large nerve passes over the bone about in the middle of the inner thigh. A blow to this area also incapacitates the leg and can cause the opponent to drop. Knee strikes and heel kicks are the weapons of choice for this target.

(4) ***Hamstring.*** A severe strike to the hamstring can cause muscle spasms and inhibit mobility. If the hamstring is cut, the leg is useless.

(5) ***Knee.*** Because the knee is a major supporting structure of the body, damage to this joint is especially detrimental to an opponent. The knee is easily dislocated when struck at an opposing angle to the joint's normal range of motion, especially when it is bearing the opponent's weight. The knee can be dislocated or hyperextended by kicks and strikes with the entire body.

(6) ***Calf.*** A powerful blow to the top of the calf causes painful muscle spasms and also inhibits mobility.

(7) ***Shin.*** A moderate blow to the shin produces great pain, especially a blow with a hard object.

A powerful blow can possibly fracture the bone that supports most of the body weight.

(8) ***Achilles tendon.*** A powerful strike to the Achilles tendon on the back of the heel can cause ankle sprain and dislocation of the foot. If the tendon is torn, the opponent is incapacitated. The Achilles tendon is a good target to cut with a knife.

(9) ***Ankle.*** A blow to the ankle causes pain; if a forceful blow is delivered, the ankle can be sprained or broken.

(10) ***Instep.*** The small bones on the top of the foot are easily broken. A strike here will hinder the opponent's mobility.

STRIKING PRINCIPLES

Effective striking with the weapons of the body to the opponent's vital points is essential for a victorious outcome in a hand-to-hand struggle. A soldier must be able to employ the principles of effective striking if he is to emerge as the survivor in a fight to the death.

a. **Attitude.** Proper mental attitude is of primary importance in the soldier's ability to strike an opponent. In hand-to-hand combat, the soldier must have the attitude that he will defeat the enemy and complete the mission, no matter what. In a fight to the death, the soldier must have the frame of mind to survive above all else; the prospect of losing cannot enter his mind. He must commit himself to hit the opponent continuously with whatever it takes to

drive him to the ground or end his resistance. A memory aid is, "Thump him and dump him!"

b. **Fluid Shock Wave.** A strike should be delivered so that the target is hit and the weapon remains on the impact site for at least a tenth of a second. This imparts all of the kinetic energy of the strike into the target area, producing a fluid shock wave that travels into the affected tissue and causes maximum damage. It is imperative that all strikes to vital points and nerve motor points are delivered with this principle in mind. The memory aid is, "Hit and stick!"

c. **Target Selection.** Strikes should be targeted at the opponent's vital points and nerve motor points. Strikes to nerve motor points cause temporary mental stunning and muscle motor dysfunction to the affected areas of the body. Mental stunning results when the brain is momentarily disoriented by overstimulation from too much input--for example, a strike to a major nerve. The stunning completely disables an opponent for three to seven seconds and allows the soldier to finish off the opponent, gain total control of the situation, or make his escape. Sometimes, such a strike causes unconsciousness. A successful strike to a nerve motor center also renders the affected body part immovable by causing muscle spasms and dysfunction due to nerve overload. (Readily available nerve motor points are shown in Figure 5-105)

RIFLE WITH FIXED BAYONET

The principles used in fighting with the rifle and fixed bayonet are the same as when knife fighting. Use the same angles of attack and similar body movements. The principles of timing and distance remain paramount; the main difference is the extended distance provided by the length of the weapon. It is imperative that the soldier fighting with rifle and fixed bayonet use the movement of his entire body behind all of his fighting techniques--not just upper-body strength. Unit trainers should be especially conscious of stressing full body mass in motion for power and correcting all deficiencies during training. Whether the enemy is armed or unarmed, a soldier fighting with rifle and fixed bayonet must develop the mental attitude that he will survive the fight. He must continuously evaluate each moment in a fight to determine his advantages or options, as well as the enemy's. He should base his defenses on keeping his body moving and off the line of any attacks from his opponent. The soldier seeks openings in the enemy's defenses and starts his own attacks, using all available body weapons and angles of attack.

Fighting Techniques. New weapons, improved equipment, and new tactics are always being introduced; however, firepower alone will not always drive a determined enemy from his position. He will often remain in defensive emplacements until driven out by close combat. The role of the soldier, particularly in the final phase of the assault, remains relatively unchanged: His mission is to close with and disable or capture the enemy. This mission remains the ultimate goal of all individual

training. The rifle with fixed bayonet is one of the final means of defeating an opponent in an assault.

1. During infiltration missions at night or when secrecy must be maintained, the bayonet is an excellent silent weapon.

2. When close-in fighting determines the use of small-arms fire or grenades to be impractical, or when the situation does not permit the loading or reloading of the rifle, the bayonet is still the weapon available to the soldier.

3. The bayonet serves as a secondary weapon should the rifle develop a stoppage.

4. In hand-to-hand encounters, the detached bayonet may be used as a handheld weapon.

5. The bayonet has many nonfighting uses, such as to probe for mines, to cut vegetation, and to use for other tasks where a pointed or cutting tool is needed.

Development. To become a successful rifle-bayonet fighter, a soldier must be physically fit and mentally alert. A well-rounded physical training program will increase his chances of survival in a bayonet encounter. Mental alertness entails being able to quickly detect and meet an opponent's attack from any direction. Aggressiveness, accuracy, balance, and speed are essential in training as well as in combat situations. These traits lead to confidence, coordination, strength, and endurance, which characterize the rifle-bayonet fighter. Differences in individual body physique may require slight changes from the described rifle-bayonet techniques. These variations will be allowed if the individual's attack is effective.

Principles. The bayonet is an effective weapon to be used aggressively; hesitation may mean sudden death. The soldier must attack in a relentless assault until his opponent is disabled or captured. He should be alert to take advantage of any opening. If the opponent fails to present an opening, the bayonet fighter must make one by parrying his opponent's weapon and driving his blade or rifle butt into the opponent with force.

1. The attack should be made to a vulnerable part of the body: face, throat, chest, abdomen, or groin.

2. In both training and combat, the rifle-bayonet fighter displays spirit by sounding off with a low and aggressive growl. This instills a feeling of confidence in his ability to close with and disable or capture the enemy.

3. The instinctive rifle-bayonet fighting system is designed to capitalize on the natural agility and combatives movements of the soldier. It must be emphasized that precise learned movements will NOT be stressed during training.

Positions. The soldier holds the rifle firmly but not rigidly. He relaxes all muscles not used in a specific position; tense muscles cause fatigue and may slow him down. After proper training and thorough practice, the soldier instinctively assumes the basic positions. All positions and movements described in this manual are for right-handed men. A left-handed man, or a man who desires to learn left-handed techniques, must use the opposite hand and foot for each phase of the movement described. All positions and movements can be executed with or without the magazine and with or without the sling attached.

Attack position. This is the basic starting position (A and B, Figure 5-106) from which all attack movements originate. It generally parallels a boxer's stance. The soldier assumes this position when running or hurdling obstacles. The instructor explains and demonstrates each move.

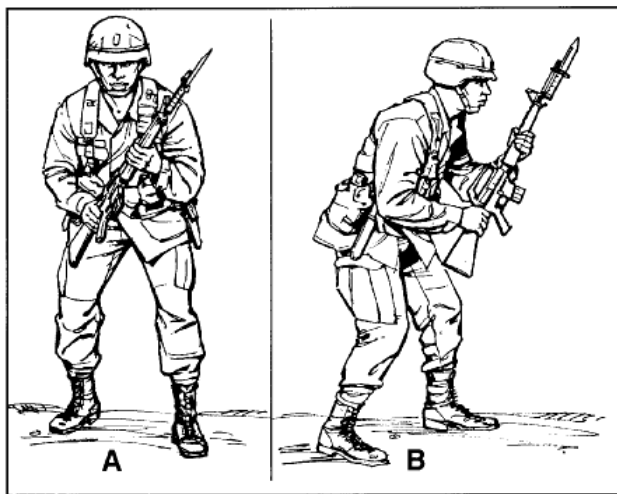

Figure 5-106. Attack Position

a. Take a step forward and to the side with your left foot so that your feet are a comfortable distance apart.

b. Hold your body erect or bend slightly forward at the waist. Flex your knees and balance your body weight on the balls of your feet. Your right forearm is roughly parallel to the ground. Hold the left arm high, generally in front of the left shoulder. Maintain eye-to-eye

contact with your opponent, watching his weapon and body through peripheral vision.

c. Hold your rifle diagonally across your body at a sufficient distance from the body to add balance and protect you from enemy blows. Grasp the weapon in your left hand just below the upper sling swivel, and place the right hand at the small of the stock. Keep the sling facing outward and the cutting edge of the bayonet toward your opponent. The command is, **ATTACK POSITION, MOVE**. The instructor gives the command, and the soldiers perform the movement.

Relaxed position. The relaxed position (Figure 5-107) gives the soldier a chance to rest during training. It also allows him to direct his attention toward the instructor as he discusses and demonstrates the positions and movements. To assume the relaxed position from the attack position, straighten the waist and knees and lower the rifle across the front of your body by extending the arms downward. The command is, **RELAX**. The instructor gives the command, and the soldiers perform the movement.

Movements. The soldier will instinctively strike at openings and become aggressive in his attack once he has learned to relax and has developed instinctive reflexes. His movements do not have to be executed in any prescribed order. He will achieve balance in his movements, be ready to strike in any direction, and keep striking until he has disabled his opponent. There are two basic movements used throughout bayonet instruction: the whirl and the crossover. These movements develop instant reaction to



Figure 5-107 Relaxed Position

commands and afford the instructor maximum control of the training formation while on the training field.

Whirl movement. The whirl (Figure 5-108, Steps 1, 2, and 3), properly executed, allows the rifle-bayonet fighter to meet a challenge from an opponent attacking him from the rear. At the completion of a whirl, the remains in the attack position. The rifle instructor explains and demonstrates how to spin your body around by

pivoting on the ball of the leading foot in the direction of the leading foot, thus facing completely about. The command is, WHIRL. The instructor gives the command, and the soldiers perform the movement.

Crossover movement. While performing certain movements in rifle-bayonet training, two ranks will be moving toward each other. When the soldiers in ranks come too close to each other to safely execute additional movements, the crossover is used to separate the ranks a safe distance apart. The instructor explains and

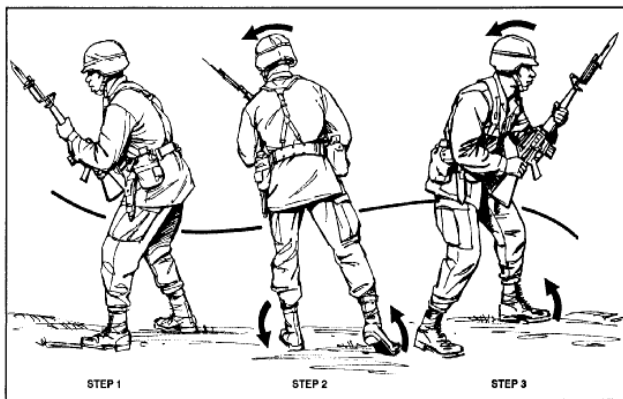

Figure 5-108. Whirl Movement

demonstrates how to move straight forward and pass your opponent so that your right shoulder passes his right shoulder, continue moving forward about six steps, halt, and without command, execute the whirl. Remain in the attack position and wait for further commands. The command is, CROSSOVER. The instructor gives the command, and the soldiers perform the movement.

NOTE: Left-handed personnel cross left shoulder to left shoulder.

Attack movements. There are four attack movements designed to disable or capture the opponent: thrust, butt stroke, slash, and smash. Each of these movements may be used for the initial attack or as a follow-up should the initial movement fail to find its mark. The soldiers learn these movements separately. They will learn to execute these movements in a swift and continuous series during

subsequent training. During all training, the emphasis will be on conducting natural, balanced movements to effectively damage the target. Precise, learned movements will not be stressed.

Defensive movements. At times, the soldier may lose the initiative and be forced to defend himself. He may also meet an opponent who does not present a vulnerable area to attack. Therefore, he must make an opening by initiating a parry or block movement, then follow up with a vicious attack. The follow-up attack is immediate and violent.

All training will stress damage to the target and violent action, using natural movements as opposed to precise, stereotyped movements. Instinctive, aggressive action and balance are the keys to offense with the rifle and bayonet.

SECTION V TACTICAL SKILLS

This section includes one SEE task (the first task in the section) and three SURVIVE tasks from STP 21-1-SMCT.

REPORT INFORMATION OF POTENTIAL INTELLIGENCE VALUE

301-348-1050

CONDITIONS

1. The commander tasks you to report information concerning the enemy, terrain, and weather in specific locations.
2. You have observed enemy activity and significant terrain and weather features.

3. You have a means of communication (radio, wire, cable, or messenger).

STANDARDS

Transmit information to the receiving authority in size, activity, location, unit, time, and equipment (S-A-L-U-T-E format) and significant terrain and weather conditions via radio, wire, cable, or written message with a messenger within 5 minutes after observation with six out of six S-A-L-U-T-E items correctly identified.

NOTE: Your unit SOP (Standing Operating Procedures) will specify the receiving authority. Examples of receiving authorities are company commander, team commander, or S2 (Intelligence Officer [U.S. Army]) section.

TRAINING AND EVALUATION

Training Information Outline

WARNING

Do not wait until you have complete enemy information to transmit. Even small amounts of combat information may provide indicators of enemy intentions.

1. Identify information concerning enemy activity and significant terrain and weather features including:

a. Order of battle factors; for example, enemy weapons systems, troop composition, and direction of movement.

NOTE: If you cannot identify a weapon system or vehicle by name, include a description of the equipment.

b. Military aspects of terrain; for example, observation and fire, concealment and cover, obstacles, key terrain and avenues of approach.

c. Weather factors; for example, severe weather, precipitation, trafficability, surface winds and gusts, and ground visibility.

NOTE: Spot reports are used to transmit information and intelligence of immediate value. Transmit spot reports as rapidly and securely as possible. The S-A-L-U-T-E format, Table 5-109, is an aid for the observer to report the essential reporting elements. It is permissible to precede each message segment of the spot report with the meaning of the acronym S-A-L-U-T-E.

2. Draft message summarizing information in the SALUTE format.

3. Select a means of communication; for example, radio, wire, cable, or messenger.

NOTE: Consider the communications means available to you and the information's potential significance to your mission. Radio is fast and mobile; yet, normally it is the least secure of the three communications means available at tactical units. Wire is more secure, but is subject to wiretapping and requires more time, personnel, and equipment to install. Messenger is very secure, but

requires more delivery time and is limited by weather, terrain, and enemy action.

LETTER	WORD	DESCRIBES
S	Size	The number of personnel seen or size of an object.
A	Activity	What the enemy was doing.
L	Location	Grid coordinates or reference from a known point including the distance and direction (or azimuth) from a known point.
U	Unit	Any patches or clothing, distinctive signs or symbols, or identification (ID) numbers on vehicles.
T	Time	Time the activity was observed.
E	Equipment	All equipment associated with the activity.

Table 5-109. The salute format.

4. Transmit the message to the receiving authority.

a. If using a messenger, provide the messenger with explicit reporting instructions and a message, preferably written, which is clear, complete, and concise.

b. If using a radio, use proper radio/telephone procedures according to unit SOP and FM 24-1. Use the radio only as needed. The enemy may intercept your transmission, exploit the message information, or locate your transmitter for targeting or jamming.

c. If you encounter jamming or interference on your radio net, within 10 minutes of the incident, transmit a meaconing, intrusion, jamming, and interference (MIJI) report, preferably via messenger, wire, or cable to your net control station. Your Signal Operating Instructions (SOI) contains the MIJI format.

MOVE UNDER DIRECT FIRE

071-326-0502

CONDITIONS

Given a tactical situation where you must approach an enemy position from a distance of 250 to 300 meters across varied terrain, armed with an M16A2 rifle or M203 grenade launcher, wearing load carrying equipment (LCE), and being a member of a two-man team.

STANDARDS

Move to within 100 meters of the enemy position, using the correct individual tactical fire and movement techniques that are dictated by terrain features. Coordinate movement with team members to provide covering fire for each member.

TRAINING AND EVALUATION

Training Information Outline

1. Select an individual movement route within your team or squad route or axis of advance (Figure 5-110).

a. Search the terrain to your front for—

(1) A gully, ravine, ditch, or wall at a slight angle to your direction of movement.

NOTE: These features provide cover and concealment when using the low or high crawl.

(2) Hedgerows or a line of thick vegetation.

NOTE: These features provide only concealment when using the low or high crawl.

(3) Large trees, rocks, stumps, fallen timber, rubble, vehicle hulks, folds or creases in the ground.

NOTE: These features provide cover and concealment for use as temporary positions. Use the rush if the area between them has no concealment.

(4) High grass or weeds.

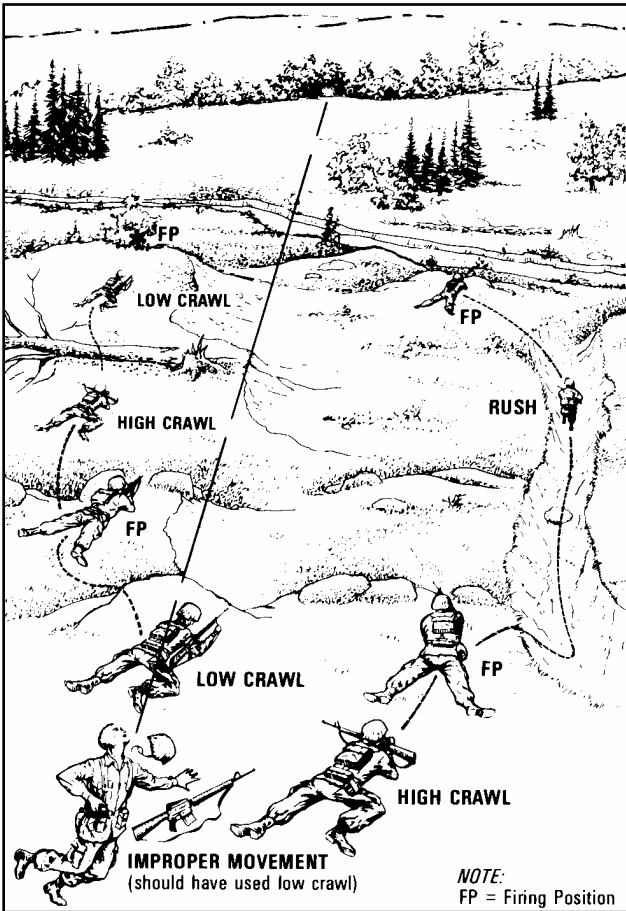

Figure 5-110. Individual movement route.

NOTE: These features provide only partial concealment. You can use the rush since the use of the high or low crawl could reveal your location by the movement of vegetation.

b. Select your next position (and the route to it) as one that:

(1) Exposes you to the least enemy fire.

(2) Does not require you to cross in front of other members of your element, masking their fires.

2. Determine the correct individual movement technique.

a. Select the high crawl when—

(1) The route provides cover and concealment.

(2) Poor visibility reduces enemy observation.

(3) Speed is required but the terrain and vegetation are suitable only for the low crawl.

b. Select the low crawl when—

(1) The route provides cover or concealment less than 1 foot high.

(2) Visibility provides the enemy good observation.

(3) Speed is not required.

c. Select the rush when—

(1) You must cross open areas.

(2) Time is critical.

3. Communicate the movement plan to your buddy or team leader using hand signals so that the soldier not moving can cover by fire any movement by the other soldier.

NOTE: When moving as a member of a fire team, watch and listen to your team leader who will lead you along the best route available and ensure that covering fire is provided when you move. Stay with your team leader and follow his or her example.

4. Use the high crawl (Figure 5-111).

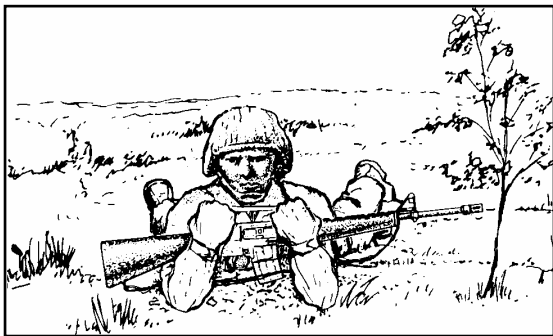

Figure 5-111. High Crawl

a. Keep your body off of the ground.

b. Rest your weight on your forearms and lower legs.

c. Cradle your weapon in your arms, keeping its muzzle off the ground.

d. Keep your knees well behind your buttocks so it stays low.

e. Move forward by alternately advancing your right elbow and left knee, and left elbow and right knee.

5. Use the low crawl (Figure 5-112).

a. Keep your body as flat as possible to the ground.

b. Hold your weapon by grasping the sling at the upper swivel, letting the handguard rest on your forearm and the butt of the weapon drag on the ground, thus keeping the muzzle off the ground.

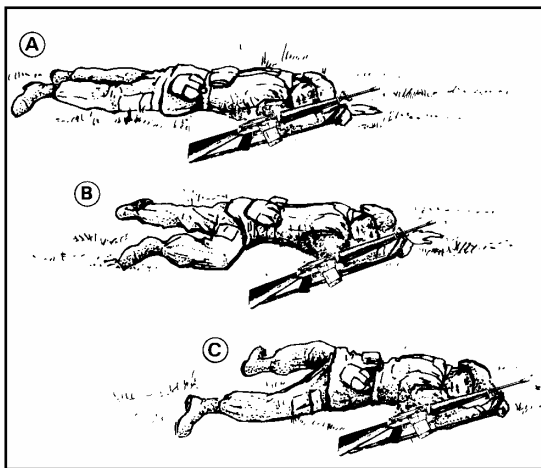

Figure 5-112. Low crawl.

c. Move forward by—

(1) Pushing both arms forward while pulling your right leg forward.

(2) Pulling with both arms while pushing with your right leg.

(3) Continuing this push-pull movement until you reach your next position, changing your pushing leg frequently to avoid fatigue.

6. Use the rush to move from one covered position to another when enemy fire allows brief exposure (Figure 5-113).

a. Move from your firing position by rolling or crawling.

b. Start from the prone position.

c. Select your next position by slowly raising your head.

d. Lower your head while drawing your arms into your body, keeping your elbows down, and pulling your right leg forward.

e. Raise your body in one movement by straightening your arms.

f. Spring to your feet, stepping off with either foot.

g. Run to the next position—

(1) Keeping the distance short to avoid accurate enemy fire.

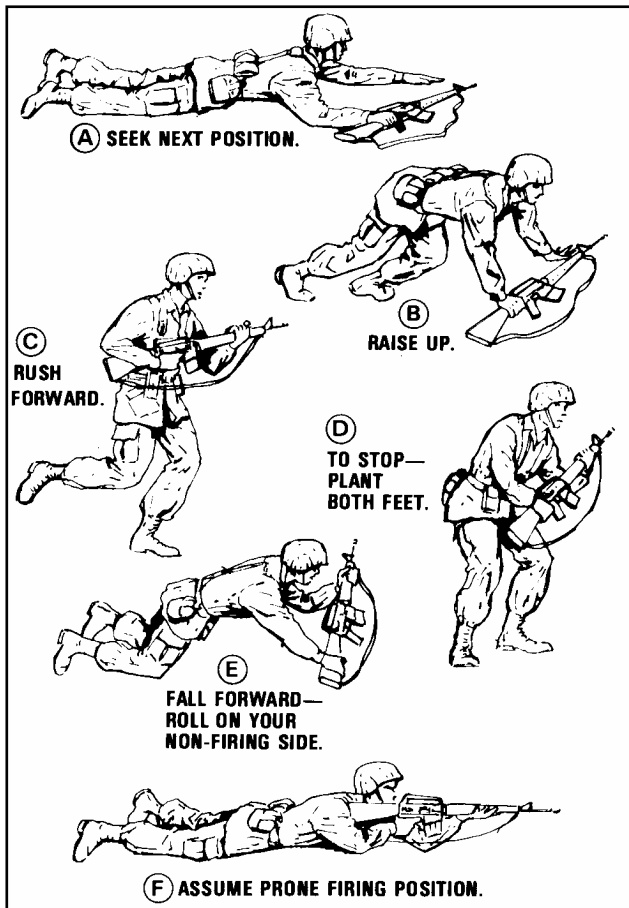

Figure 5-113. Rush.

(2) Trying not to stay up any longer than 3 to 5 seconds so that the enemy does not have time to track you with automatic fire.

h. Plant both feet just before hitting the ground.

i. Fall forward by—

(1) Sliding your right hand down to the heel of the butt of your weapon.

(2) Breaking your fall with the butt of your weapon.

j. Assume a firing position.

(1) Roll on your side.

(2) Place the butt of your weapon in the hollow of your shoulder.

(3) Roll or crawl to a covered or concealed firing position.

7. Cover your buddy's movement with fire.

REACT TO FLARES

071-326-0511

CONDITIONS

Given a tactical situation at night, upon hearing a flare rising or when suddenly illuminated by a ground or overhead flare.

STANDARDS

React to a ground or an overhead flare without being seen by the enemy or losing your night vision.

TRAINING AND EVALUATION

Training Information Outline

1. Respond to ground flares.
 - a. Move out of the illuminated area.
 - b. Reorient yourself when alone or in a group by standard operating procedure (SOP), or as instructed.
 - c. Continue the mission.
2. Respond to an overhead flare with warning (for example, the sound of a rising flare).
 - a. Assume the prone position (behind concealment when available) before the flare bursts.
 - b. Protect your night vision by closing one eye and observing with the other.

c. Use your night vision eye to reorient yourself or rejoin your group when the flare burns out.

d. Continue the mission.

3. Respond to an overhead flare without warning.

a. Assume the prone position behind concealment (when available) until the flare burns out.

b. Protect your night vision by closing one eye and observing with the other.

c. Crouch low until the flare burns out when crossing wire obstacles where the prone position is not possible.

d. Use your night vision eye to reorient yourself or rejoin your group when the flare burns out.

e. Continue the mission.

CHALLENGE PERSONS ENTERING YOUR AREA 071-331-0801

CONDITIONS

Given the current challenge and password and a defensive position with a designated sector of fire, your individual weapon and load carrying equipment (LCE). Enemy and friendly personnel may enter your sector.

STANDARDS

Detect and halt all personnel in your sector and challenge them, using the correct challenge. Allow personnel with

the correct password to pass and detain (capture) personnel without the password. Do not allow the enemy to overhear the password.

TRAINING AND EVALUATION

Training Information Outline

1. One person desires to pass.

a. On seeing or hearing someone approach your position, command the person to halt before that person gets close enough to pose a threat. Use a clear voice, just loud enough to be heard.

b. Seeing the stranger halt, keep him or her covered and, without exposing your position, ask "who is there?" Again, use a clear voice just loud enough to be heard so the enemy will not overhear if nearby.

c. When the stranger identifies himself or herself, such as "Private Willard, messenger," you order him or her to "Advance to be recognized."

d. Maintain your concealed position and keep the stranger covered with your weapon. When the stranger gets within 2 or 3 meters of you, again order him or her to halt.

e. Issue the challenge in a soft voice and wait for the stranger to reply with the correct password. On hearing the correct password, give permission to pass if you have no other reason for doubt. If doubt still exists, demand further

identification or ask a question only a friendly person would be able to answer.

2. A group desires to pass.

a. The procedure and precautions for a group are almost the same as for one person. On seeing or hearing a group approach, order them to halt before they are close enough to pose a threat.

b. The leader of the group should identify the group, such as "Friendly patrol." Since you do not want the whole group to advance on you at once, order "Advance one person to be recognized."

c. When the leader has come forward to be recognized, give him or her the challenge and get the password in reply.

d. Once you are satisfied that the leader is friendly, tell the rest of the patrol to advance one by one and ensure the leader identifies each person.

e. Disarm and detain any person(s) not able to identify themselves to the leader's satisfaction. Then, notify your immediate supervisor.

SECTION VI

NUCLEAR, BIOLOGICAL, CHEMICAL

This section includes eight PROTECT AGAINST NBC ATTACK tasks from STP 21-1-SMCT.

Standard Mission-Oriented Protective Postures

All soldiers need to be familiar with standard MOPP levels. Standardized MOPP levels allow commanders to increase or decrease levels of protection through the use of readily understood prowords. Commanders determine which protective posture their subordinate units will assume (Figure 5-114), and then direct their units to assume that MOPP level.

MOPP Zero

Soldiers carry their protective masks with their LCE. The standard Battle Dress Overgarment and other IPE making up the soldier's MOPP gear are readily available. To be considered readily available, equipment must be either carried by each soldier or stored within arms reach of the soldier; for example, within the work area, vehicle, or fighting position. Units in MOPP Zero are highly vulnerable to persistent agent attacks and will automatically upgrade to MOPP1 when they determine, or are notified, that persistent chemical weapons have been used or that the threat for use of chemical weapons has risen.

MOPP1

When directed to MOPP1, soldiers immediately don the Battle Dress Overgarment. In hot weather, the overgarment jacket can be unbuttoned, and the Battle Dress Overgarment can be worn directly over underwear. M9 or M8 chemical detection paper is attached to the overgarment. MOPP1 provides a great deal of protection against persistent agent. This level is automatically assumed when chemical weapons have been employed in an area of operations or when directed by higher commands.

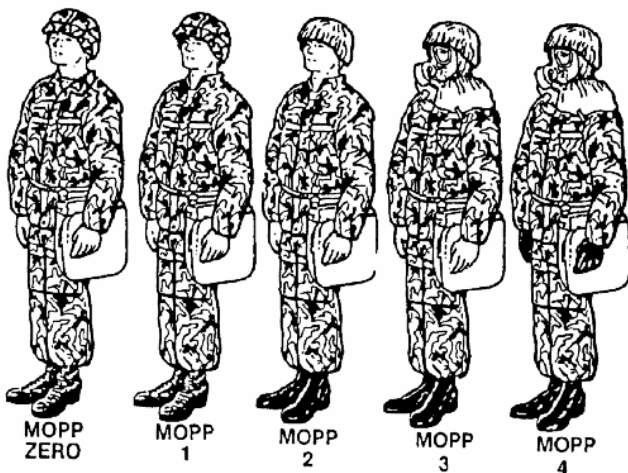

MOPP EQUIP	MOPP 0	MOPP 1	MOPP 2	MOPP 3	MOPP 4
Mask	Carried	Carried	Carried	Worn	Worn
Over-garment	Available	Worn	Worn	Worn	Worn
Over-boots	Available	Available	Worn	Worn	Worn
Gloves	Available	Available	Available	Available	Worn
Helmet Cover	Available	Available	Worn	Worn	Worn

Figure 5-114. Standardized MOPP Levels

MOPP2

Soldiers put on their chemical protective footwear covers (CPFCs), GVOS, or a field expedient item (for example, vapor-barrier boots) and the protective helmet cover is worn. As with MOPP1, the overgarment jacket may be left unbuttoned, but trousers remain closed.

MOPP3

Soldiers wear the protective mask and hood. Again, flexibility is built into the system to allow soldiers relief at MOPP3. Particularly in hot weather, soldiers can open the overgarment jacket and roll the protective mask hood for ventilation, but trousers remain closed.

MOPP4

Soldiers will completely encapsulate themselves by closing their overgarments, rolling down and adjusting the mask hood, and putting on the NBC rubber gloves with cotton liners. MOPP4 provides the highest degree of chemical protection.

REFERENCE

FM 3-4

DETECT CHEMICAL AGENTS USING M8 OR M9 DETECTOR PAPER 031-503-1037

CONDITIONS

You are in an area where there is a chemical threat and are in mission-oriented protective posture (MOPP) level 2. You have a booklet of M8 detector paper, a dispenser of M9 detector paper, assigned decontaminating kits

(M258A1 or M291/M295), and a complete set of MOPP gear.

STANDARDS

1. Attached M9 detector paper in places likely to come into contact with liquid chemical agents.
2. Detected all liquid chemical agents in your area without becoming a casualty.
3. Identified all liquid chemical agents within the capability of M8 detector paper. NOTE: There is no degradation of standards if performed in MOPP level 4.

TRAINING AND EVALUATION

Performance Steps:

WARNING

The M9 Detector Paper Dye May Cause Cancer, But Because Very Little Dye is Used, The Risk Is Small. Always Wear Protective Gloves When Touching M9 Detector Paper. Do Not Place M9 Detector Paper In Or Near Your Mouth Or On Your Skin.

1. Use M9 Detector Paper.
 - a. Attach M9 paper to MOPP gear and equipment while wearing chemical protective gloves.
 - (1) Place the M9 detector paper on MOPP gear on opposite sides of the body.

- (a) If you are right handed, place a strip of M9 paper around your right upper arm, left wrist, and around your right ankle.
- (b) If you are left handed, place a strip of M9 paper around your left upper arm, right wrist, and around your left ankle.

NOTE: These are the places where a moving soldier will most likely brush against a surface (undergrowth, etc.) that is contaminated with a liquid chemical agent.

(2) Place M9 detector paper on equipment where it will come in contact with contaminated objects and is visible to the operator.

NOTE: Do not attach M9 detector paper to hot, dirty, oily, or greasy surfaces since it may give a false positive reading.

- b. Constantly monitor the M9 detector paper for any color change. If you observe a color change:
 - (1) Mask.
 - (2) Give the alarm.
 - (3) Decon as necessary and assume MOPP Level 4

WARNING

Some Decontaminates Give False Positive Results On The M8 Detector Paper. The M8 Detector Paper May Indicate Positive Results If Used In An Area Where Decontaminates Have Been Used.

2. Use M8 Detector Paper if you see a liquid that might be a chemical agent or you observe a color change on the M9 detector paper.
 - a. Immediately assume MOPP level 4.
 - b. Prepare M8 detector paper. Tear out a sheet from the book (use one-half sheet if the M8 Paper is perforated).
 - c. Blot (DO NOT RUB) the M8 detector paper on the suspected liquid agent without touching the liquid with your protective glove.

NOTE: You may want to put the paper on the end of a stick or another object; then blot the paper on the suspected liquid agent.

- d. Observe the M8 paper for a color change. Identify contamination by comparing any color change on the M8 paper to the color chart on the inside cover of the booklet:
 - (1) A yellow-gold color indicates the presence of G (nerve) agent.

- (2) A red-pink color indicates the presence of H (blister) agent.
 - (3) A dark green color indicates the presence of V (nerve) agent.
 - (4) If any color is present or if there is no color change, the liquid cannot be identified by using M8 detector paper.
- e. Store the booklet of M8 detector paper.
 - f. Remain in MOPP 4 even if the liquid cannot be identified. Use other types of chemical agent detectors (example: M256 Detector Kit, Chemical Agent Monitor) to verify test results.
 - g. Notify your supervisor of the test results.

REACT TO A NUCLEAR HAZARD

031-503-1018

CONDITIONS

Given an area where nuclear weapons have been or may have been used. You must respond to one of the following situations where you:

1. See a brilliant flash of light.
2. Find a standard radiological contamination marker or an enemy marker similar to those used by former Warsaw Pact nations.
3. Receive instructions to respond to a nuclear attack.

STANDARDS

1. Protect yourself from the effects of a nuclear attack with no warning by reducing your exposure to the effects of the blast.
2. Protect yourself from the effects of a nuclear attack with advance warning by reducing your exposure to the effects of the blast.
3. Identify radiological contamination markers with 100 percent accuracy and notify your supervisor.

TRAINING AND EVALUATION

Training Information Outline

1. React to a nuclear attack with no warning (a brilliant flash of light).
 - a. Close your eyes immediately.
 - b. Drop to the ground in a prone, head-on position. If in the hatch of an armored vehicle, immediately drop down inside the track.
 - c. Keep your head and face down and your helmet on.
 - d. Stay down until the blast wave passes and debris stops falling.
 - e. Check for casualties and damaged equipment.
2. React to nuclear attack with warning.

a. Find the best available shelter.

(1) Move into a foxhole, bunker, or ditch.

NOTE: The foxhole puts more earth between soldiers and the potential source of radiation.

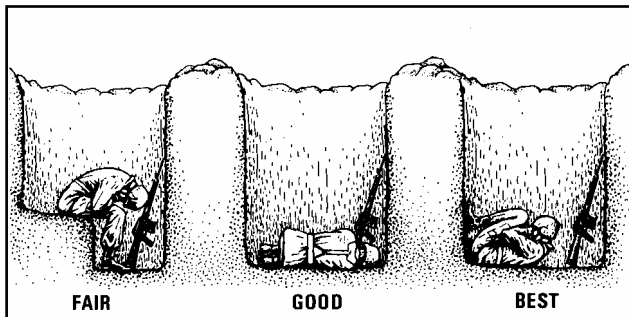

Figure 5-115. Protective positions in foxholes.

(a) Lie on your back as low in the foxhole as possible with your knees drawn up to your chest (Figure 5-115).

NOTE: The belly up position may seem more vulnerable, but the position of the arms and bent legs are more radiation resistant, thus protecting the head and trunk.

NOTE: You can also curl up on one side, but this is not the best position.

(b) Cover your face and hands with packs or a radio, if possible, to provide additional radiation and blast protection.

(c) Store bulky equipment such as packs or radios in an adjacent pit if they prevent getting as low as possible in the foxhole.

(2) Take protective actions if inside a shelter.

NOTE: A blast wave can enter the shelter with great force, and the debris it carries can cause injury. Near a wall, the pressure wave may be increased by reflection. This is better, however, than being blown around and injured by the blast.

(a) Take a position near a wall but in an area where you will avoid the violent flow of air from a door or window.

(b) Construct baffles or turns in shelter entrances to prevent overpressure buildups and entry of dust and debris if there is time to do so (Figure 5-116).

(c) Lie facedown on the floor of the shelter.

(d) Stay in the shelter until the blast wave passes and the debris stops falling.

(3) Remain in place if you are in an armored vehicle.

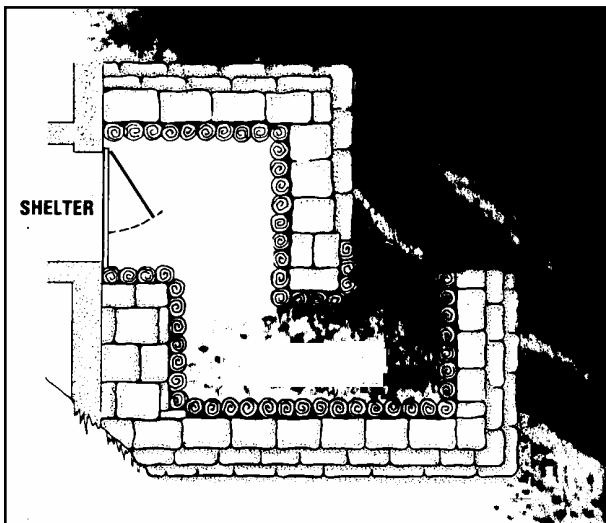

Figure 5-116. Protection in shelter.

b. Keep clothes loosely fitted and headgear on at all times.

c. Protect your eyes.

d. Minimize exposed skin areas.

3. React to radiological markers if you see either a standard radiological contamination marker (Figure 5-117) or an enemy radiological contamination marker similar to those used by former Warsaw Pact nations (Figure 5-118).

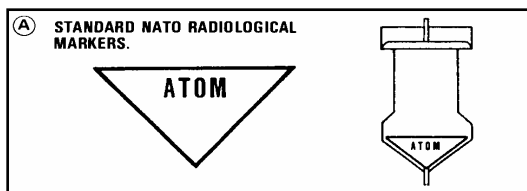

Figure 5-117. Standard radiological contamination markers.



Figure 5-118. Former Warsaw Pact radiological contamination marker.

- a. Avoid the area if possible.
- c. Cross the area quickly by the shortest route.
 - (1) Request crossing instructions if you must cross.
 - (2) Make maximum use of shielding.
- c. Report the discovery of a marker to your supervisor.

**REACT TO CHEMICAL OR
BIOLOGICAL HAZARD OR ATTACK
031-503-1019**

CONDITIONS

Given a tactical environment in which chemical or biological (CB) weapons have been used or may be used by the enemy. You are in Mission-Oriented Protective Posture (MOPP) level 1 and you experience one of the following situations:

1. Hear a chemical alarm.
2. Obtain a positive reading from detector paper or a chemical agent monitor.
3. See individuals who exhibit symptoms of chemical or biological agent poisoning.
4. See a marker similar to a Warsaw Pact contamination marker (see the task React To A Nuclear Hazard, task number 031-503-1018 and Figure 5-118).
5. Are told to mask.
6. Come upon personnel wearing protective masks.
7. See other signs of possible chemical or biological attack.

STANDARDS

Don your assigned protective mask with hood within the allowable time period for that mask. Then give the alarm both orally and visually. Next, take cover in the most protected immediate location available. Decontaminate any contaminated skin. Don MOPP gear until you reach level 4. Report the current situation to your supervisor. Perform these actions exactly in this sequence.

TRAINING AND EVALUATION

Training Information Outline

1. Don your mask without securing the hood.
2. Give the alarm.
 - a. Yell "gas."
 - b. Give arm-and-hand signal (Figure 5-119).
3. Take cover using whatever cover is readily available to decrease the amount of agent contact.

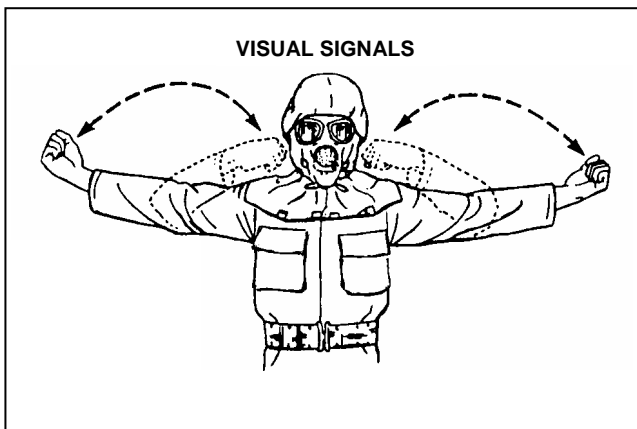

5-119. Chemical attack arm-and-hand signal.

NOTE: Figure 5-120, shows some examples of how cover can decrease the amount of liquid contamination

4. Decontaminate exposed skin as necessary (see the task Decontaminate Your Skin And Personal Equipment Using An M258A1 Decontamination Kit, task number 031-503-1007).
5. Assume MOPP4 (see the task Protect Yourself From NBC Injury/Contamination With Mission-Oriented Protective Posture [MOPP] Gear, task number 031-503-1015).
 - a. Put on your gloves with liners. The idea is to cover all skin. The head and body are protected by the mask and overgarment.
 - b. Secure your overgarment jacket.

- c. Secure the hood.
- d. Put on your overboots.

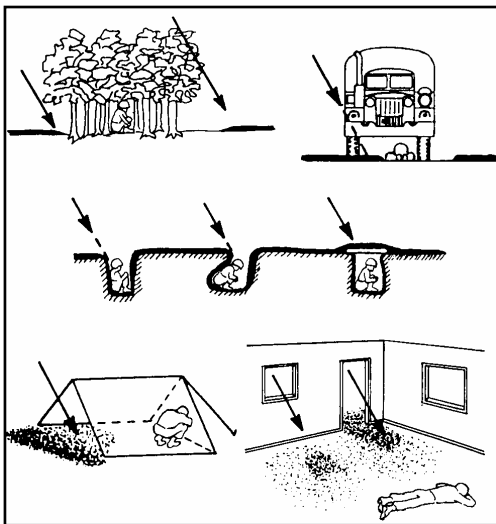

Figure 5-120. Example of protective cover against liquid chemical attack

- 6. Decontaminate personal equipment as necessary (see the task Decontaminate Your Skin and Personal Equipment Using An M258A1 Decontamination Kit, task number 031-503-1007).
- 7. Notify your supervisor.
- 8. Continue the mission.

**REPLACE CANISTER ON YOUR
M40-SERIES PROTECTIVE MASK
031-503-1024**

CONDITIONS

You are assigned an M40 or M42 protective mask. You have a defective filter canister and a replacement canister.

STANDARDS

Remove the defective canister and install a new canister on the M40 or M42 protective mask so that the mask will be operational and no damage is done to the mask.

TRAINING AND EVALUATION

Training Information Outline

1. Replace a canister on an M40 protective mask.
 - a. Remove the canister by unscrewing it counter-clockwise from the facepiece.
 - b. Check the connectors of the new canister, the mating surfaces of the facepiece, and the areas between these surfaces for dirt or other debris which would allow contaminated air into your facepiece.
 - c. Check the expiration date on the new canister to ensure the canister has not expired.

WARNING

An expired canister will not filter toxic agents.

d. Insert the new canister into the side port of the facepiece.

e. Tighten the canister by screwing it clockwise. The canister will be hand-tight only.

2. Replace a canister on an M42 protective mask.

a. Remove the canister carrier cover by pressing in and rotating it counterclockwise.

b. Remove the canister by unscrewing it counterclockwise from the hose and removing it from the canister carrier.

c. Check the connectors of the new canister, the mating surfaces of the facepiece, and the areas between these surfaces for dirt or other debris which would allow contaminated air into your facepiece.

d. Check the expiration date on the new canister to ensure the canister has not expired.

WARNING

An expired canister will not filter toxic agents.

e. Insert the canister into the canister carrier.

f. Make sure the gasket is in the canister connection before connecting the canister to the hose.

WARNING

A missing gasket will affect the seal and will allow the wearer to inhale contaminated air.

g. Attach the canister to the hose.

(1) Position the hose on the canister.

(2) Tighten the canister by screwing it clockwise into the hose while holding the hose securely.

h. Attach the canister carrier cover to the carrier.

(1) Position the canister carrier cover on the canister carrier.

(2) Press in on the canister carrier cover while rotating it clockwise.

PROTECT YOURSELF FROM CHEMICAL AND BIOLOGICAL INJURY OR CONTAMINATION USING YOUR M40-SERIES PROTECTIVE MASK WITH HOOD 031-503-1025

CONDITIONS

You have your assigned M40-series protective mask with hood. You find yourself in one any of the following situations where you:

1. Hear or see a chemical or biological alarm that indicates the presence of an agent.

2. Realize otherwise that you are under a chemical or biological attack.
3. Are ordered to mask.

STANDARDS

Don your M40-series protective mask within 9 seconds (including clearing and checking the mask). Pull the hood over your head and zip the front closed to cover all your bare skin.

TRAINING AND EVALUATION

Training Information Outline

1. Don your mask within 9 seconds.
 - a. Stop breathing.
 - b. Close your eyes.
 - c. Remove your helmet and do one of the following:
 - (1) Store it between your legs above the knees.
 - (2) Hold your rifle between your legs and place the helmet on the flash suppressor.

WARNING

Do not wear contact lenses with the protective mask. Remove contact lenses when the use of chemical agents is imminent.

- d. Take off your glasses if you are wearing them.
- e. Open the carrier with your left hand holding the carrier open.
- f. Remove the mask from the carrier by grasping the mask with your right hand.
- g. Put your chin in the chin pocket.
- h. Grasp the head harness and pull it over your head. Be sure your ears are between the temple straps and cheek straps. Center the head pad at the high point on the back of your head (Figure 5-121).

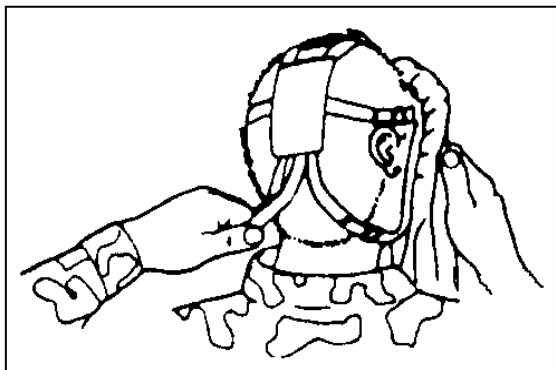

Figure 5-121. Center headpad.

- i. Use the other hand to tighten the cheek straps one at a time while holding the head pad centered on the back of your head (Figure 5-122).

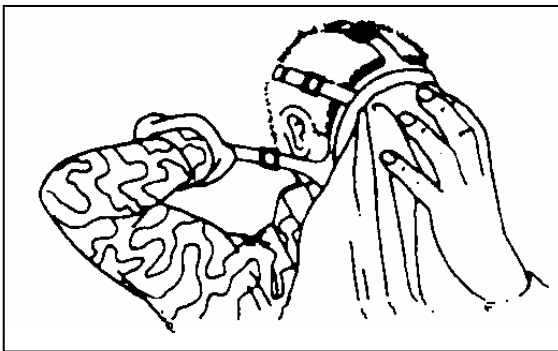

Figure 5-122. Tighten cheek straps.

NOTE: The straps should lie flat against your head.

j. Clear the mask.

(1) Clear the outlet valve by pushing in on the center of the valve cover with one hand.

(2) Blow out hard so that air escapes around the edges of the mask.

(3) Cover the inlet port of the canister with the palm of your hand (Figure 5-123).

(4) Breathe in.

(5) Remove anything preventing a seal from forming between your face and the mask.

NOTE: The facepiece should collapse against your face and remain so while you hold your breath. If it does, the
5-232

facepiece is airtight. If the facepiece does not collapse, check for hair, clothing, or other matter between the facepiece and your face (Figure 5-123).

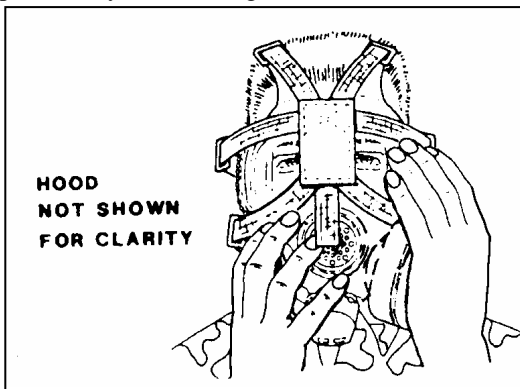

Figure 5-123. Clear and check mask.

k. Resume breathing.

2. Don the hood so that it lies smoothly on your head (Figure 5-124).



Figure 5-124. Pull hood over head.

CAUTION

Be very careful when pulling on the hood. The hood could snag on the buckles of the head harness and tear.

- a. Grasp the back edge of the hood skirt.
- b. Pull the hood carefully over your head so that it covers the back of your neck, head, and shoulders.
- c. Zip the front of the hood closed by pulling the zipper slider downward if so equipped (A in Figure 5-125).

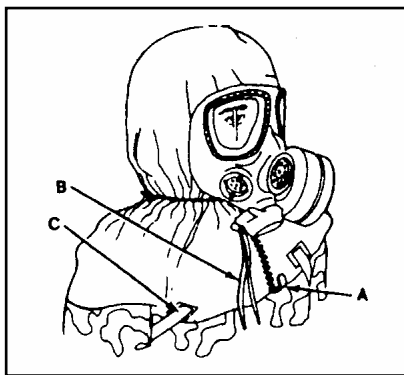

Figure 5-125. Completely fastened mask.

- d. Tighten the draw cord (B in Figure 5-125).
 - e. Secure the underarm straps by fastening and adjusting them (C in Figure 5-125).
 - f. Put on your helmet.
 - g. Close your mask carrier.
 - h. Continue the mission.
3. Remove your protective mask with hood after the "all clear" order is given.
 - a. Remove your helmet.
 - b. Unfasten the underarm straps.

- c. Loosen the draw cord.
- d. Unzip the zipper on the hood.
- e. Remove the hood (Figure 5-126).
 - (1) Place both hands on the back edge of the hood skirt.
 - (2) Raise the hood over your head.
 - (3) Pull the hood over the front of the mask.



Figure 5-126. Pull hood over facepiece.

- f. Loosen the cheek straps.
- g. Remove the mask.

(1) Place one hand on the front of the voicemitter to hold the facepiece to your face.

(2) Grasp the head harness tab with your other hand.

(3) Pull the head harness over the front of the mask.

(4) Remove the mask from your head.

h. Replace your helmet on your head.

i. Remove any moisture from the hood and mask.

(1) Shake off any moisture.

(2) Wipe any moisture from the hood and the mask.

4. Store your mask with hood.

a. Hold the front of the mask in a horizontal position.

b. Smooth the hood over the mask.

c. Pull the head harness over the front of the mask.

d. Fold the two edges of the hood over the outlet valve to create a V in the front of the hood (Figure 5-127).

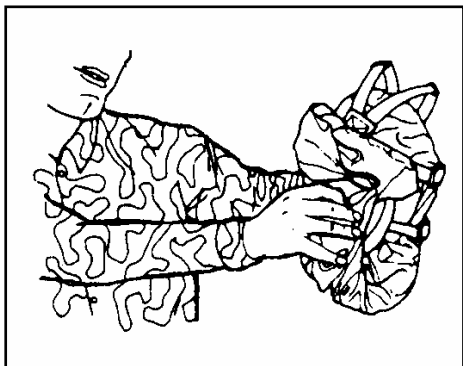

Figure 5-127. Folding hood.

- e. Store the underarm straps and the cord in the V.
- f. Fold the V upward to cover the eye lenses without letting the hood cover the chin opening.
- g. Put the mask with hood in the carrier while holding the facepiece upright with the lenses facing away from your body (Figure 5-128).
- h. Close the carrier opening.
- i. Store the mask with hood in the closed carrier in a cool, dry, dark place.
- j. Hang the carrier (A in Figure 5-129) by the hook (B in Figure 5-129) on the short strap.

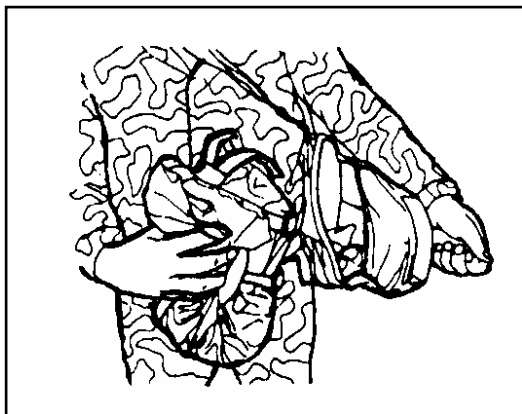

Figure 5-128. Put mask in carrier.

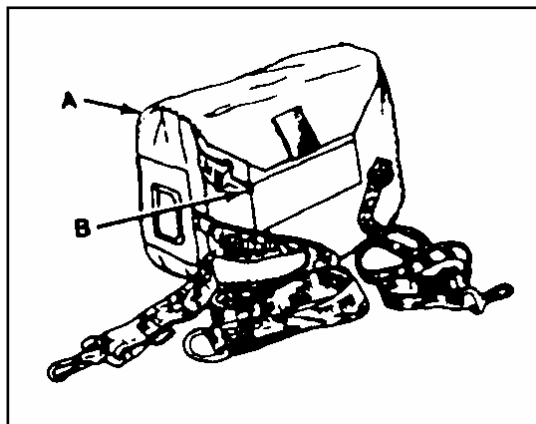

Figure 5-129. Mask carrier.

**MAINTAIN YOUR M40-SERIES PROTECTIVE
MASK WITH HOOD
031-503-1026**

CONDITIONS

You are assigned the M40-series protective mask (with authorized accessories and components). The mask needs to be cleaned. You have a container of warm, soapy water; a container of clear water; clean rags; denatured alcohol; a small brush; and optical lens cleaning compound (NSN 6850-00-592-3283).

STANDARDS

1. Identify and correct all operator-level deficiencies or shortcomings.
2. Clean the mask, removing all dirt and conditioning the mask. Use only potable water. Do not allow the canister to get wet.
3. Report deficiencies not corrected to your supervisor.

TRAINING AND EVALUATION

Training Information Outline

1. Check the carrier to ensure all issued items are present.
2. Check the filter canister for:
 - a. Cracks, dents, or holes, especially around the seams.
 - b. Clogged air intake.

- c. Damaged threads on the canister.
 - d. Loose absorbent particles by shaking the canister.
3. Check the eye lenses, the eye-rings, and the outserts.
- a. Remove the outserts from the facepiece.
 - b. Check the eye lenses for cracks, cuts, scratches, or discoloration that affect your vision.
 - c. Check the eye-rings for distortion or corrosion.
 - d. Check both sets of outsert lenses for cracks, chips, or discoloration that affect your vision.
 - e. Check the rubber rings for tears, looseness, brittle spots, soft or sticky spots, or cracked rims.
4. Check the M42 protective mask for the following:
- a. Check the hose for splits, cracks, breaks, or damage.
 - b. Check the hose to ensure that it is properly installed on the facepiece and is not loose by gently pulling it.
 - c. Remove the canister carrier from the hose.
 - d. Check the canister carrier to make sure that the gasket installed in the canister fitting at the end of the hose is present and serviceable.
 - e. Check the threads on the canister fitting for damage.

f. Pull gently on the hose fitting to make sure it will not pull free from the hose.

g. Remove the rest of the canister carrier from the facepiece hose.

h. Check the canister carrier cover to make sure that the gas particulate filter unit connection is firmly seated in the inlet post of the canister carrier cover.

i. Check the rubber seal inside the canister carrier cover for signs of separation, cuts, or other damage.

5. Check the hood.

NOTE: Remove the hood to allow inspection.

a. Examine the hood for cuts, holes, tears, sticky or gummy areas, and peeled or worn coating.

NOTE: Needle holes at the seams are acceptable.

b. Check for missing, frayed, or torn straps, cords, or hardware; torn, broken, or inoperative zipper; and loose stitching on the hook-and-pile fasteners or dirt in the fasteners.

WARNING

Do not attempt to remove the hose on the M42 protective mask from the facepiece. This may cause leakage of toxic agents into the facepiece.

6. Check the facepiece.

a. Check the inside surfaces of the facepiece for dirt, mud, and greasy or oily substances.

b. Check the facepiece for holes, tears, and splits.

c. Check the edge of the facepiece for soft or sticky spots.

d. Check all facepiece housings to be sure the silicone rubber is not pulling away, especially around the eye lenses.

NOTE: Check the M42 protective mask hose connection to be sure it is not pulling away.

7. Check the head harness.

a. Check for dirt.

b. Check the straps for cuts, tears, missing parts, or deterioration such as mildewing or fraying.

c. Check for missing, broken, bent, cracked, or corroded buckles.

d. Pull on the head harness straps to make sure the buckles hold the straps tightly.

e. Check the finish on the buckles for chips or scratches exposing bare metal.

f. Check the head harness for loss of elasticity by putting the harness on.

8. Check the outlet valve and the outlet valve disk.

a. Grasp the tab at the bottom of the outlet valve cover.

b. Carefully lift the bottom portion.

c. Check for a missing, curled, or distorted disk.

d. Check for a sticking disk by rotating it.

e. Check the outlet valve disk for any nicks, cuts, tears, or rips.

f. Check for moisture on the disk, wiping it off with a clean, lint-free cloth.

g. Smooth the disk so it lies flat on the outlet valve seat.

h. Check the outlet valve seat for dirt.

i. Check the outlet valve cover for cuts, tears, or holes.

j. Check for dirt or moisture on the inside of the cover, cleaning it off with a soft, clean, dry cloth.

9. Check the internal and external drinking tubes.

a. Check for missing tubes.

b. Check for cracks or cuts in the tubes.

c. Check the internal drinking tube for improper alignment.

d. Check the external drinking tube for improper connections.

e. Check for clogged tubes by connecting the M1 canteen cap and blowing air through the system.

f. Check the drinking system for leaks.

10. Check the airflow deflector.

a. Check the airflow deflector for:

(1) Insecure mounting inside the facepiece.

(2) Flanges on the deflector that are not in the mounting holes of the facepiece or are broken.

b. Check the mounting holes for cuts or tears.

11. Check the inlet valve.

a. Check for missing or improperly mounted inlet valve disk and valve body.

b. Check for a stuck valve body by blowing on the inlet valve disk.

c. Check the inlet valve disk for cuts, holes, tears, or dirt.

12. Check the nose cup assembly.

a. Check the nose cup and the nose cup valve seats for dirt, cracks, cuts, or holes.

b. Check for a nose cup that is not secured to the back of the front voicemitter housing by gently pulling it.

c. Check for missing, curled, torn, or improperly seated nose cup valve disks.

d. Check for stuck disks by rotating them.

13. Check the M42 protective mask for the following:

a. Blow into the free end of the hose and check to see that the inlet valve disk is not stuck to the inlet valve body.

b. Check the inlet valve disk for cuts, holes, tears, and dirt.

c. Check the microphone and microphone cable to make sure that they are not broken, cracked, or frayed.

d. Check the microphone to make sure that it is not loose on the mount inside the facepiece.

e. Unplug the microphone cable from the front voicemitter socket, checking for corrosion.

f. Check the microphone cable to make sure that it plugs securely into the front voicemitter.

14. Check the M42 protective mask microphone and microphone cable for the following:

a. Check the microphone to ensure that it is not broken, cracked, frayed, or loose on the mount inside the facepiece.

b. Unplug the microphone cable from the front voicemitter socket, checking for corrosion.

c. Check the microphone cable to ensure that it plugs securely into the front voicemitter socket.

15. Check the voicemitters.

a. Check the retaining rings on the front voicemitter and the side voicemitter for corrosion, cracks, or nicks.

b. Check for retaining rings that are not hand-tight.

c. Check the front voicemitter and the side voicemitter for dents, cracks, or punctures.

d. Check the four beads in the center of each voicemitter for one that does not face outward.

16. Check the carrier.

a. Check for dirt, sharp edges, torn straps, or missing hardware.

b. Check for pencil or pen markings on the carrier.

c. Check for mildew, solvents, or abrasive materials that may harm the facepiece.

d. Check the seams for broken stitches.

e. Check the hook-and-pile fasteners for dirt.

17. Clean your mask and carrier using only potable water and alcohol without wetting the canister.

CAUTION

Do not dunk the mask or the carrier in water. Do not allow the canister to become wet. A wet canister is useless.

NOTE: Unplug the M42 protective mask microphone cable and wash the facepiece carefully so that the microphone does not get wet.

a. Remove the canister, the outserts, and the hood.

b. Set the canister aside, away from cleaning operations so that it does not get wet.

c. Remove the outlet valve cover.

d. Remove greasy or oily substances from the facepiece with alcohol and a clean cloth.

e. Clean the eye lenses and both sets of outserts, polishing them with optical lens cleaning compound (NSN 6850-00-592-3283), if available, or warm, soapy water.

f. Dip a clean, soft cloth into warm, soapy water, wringing it out well.

g. Wipe the facepiece, the hood, and the outserts inside and out. You can use a soft brush.

h. Rinse the cloth in clean, warm water, wringing it out.

i. Wipe all washed parts.

j. Dry everything with a dry, clean, soft cloth or air dry.

CAUTION

Ensure all components are entirely dry before reassembling the mask and storing it.

k. Replace the outlet valve cover, the hood, the canister, and the outserts.

18. Clean the carrier.

a. Remove the contents from the carrier.

b. Shake the carrier upside down to remove dirt and foreign matter.

c. Soak the brush in cold water, shaking it to remove excess water.

d. Clean the carrier with the brush without soaking the carrier or using hot water, bleach, or detergent.

CAUTION

Hot water, bleach, or detergent will reduce resistance of the carrier to water and mildew.

- e. Store the carrier after it is entirely dry.

CAUTION

Ensure the carrier is entirely dry before storing components.

19. Report discrepancies to your supervisor.

DECONTAMINATE YOUR SKIN USING THE M291 SKIN DECONTAMINATING KIT (SDK) 031-503-1033

CONDITIONS

You are at Mission-Oriented Protective Posture (MOPP) level 2 with remaining MOPP gear available and have been given a full canteen of water and an M291 SDK. You find yourself in one of the following situations where you have:

1. Been attacked with chemical agents.
2. Passed through an area contaminated with chemical agents.

STANDARDS

Start to decontaminate your skin and/or eyes within 1 minute after you determine they are contaminated. Decontaminate all exposed skin and your eyes, if necessary, without getting the decontaminating powder in

your eyes or uncontaminated cuts and wounds.

TRAINING AND EVALUATION

Training Information Outline

1. Inspect the M291 SDK for loose black powder.
 - a. If no powder is detected, the kit is mission ready.
 - b. If powder is detected, inspect each packet for leaks.
 - c. Discard all leaking packets.
 - d. Reinsert good packets into the carrying pouch.
2. Verify that there are at least four skin decontaminating packets in the kit.

NOTE: If there are less than four packets, request an additional kit, continuing to use your kit until all packets are gone.

CAUTION

For external use only. May be slightly irritating to the skin or eyes. Keep decontaminating powder out of your eyes, cuts and wounds. Use water to wash toxic agent out of your eyes, cuts or wounds.

3. Decontaminate your skin with the M291 SDK within 1 minute of the suspected exposure.
 - a. Put on your mask and hood without—

(1) Zipping the hood.

(2) Pulling the draw strings.

(3) Fastening the shoulder straps.

b. Seek overhead cover for protection against further contamination.

c. Remove one skin decontaminating packet from the carrying pouch.

d. Tear the packet open quickly at the notch.

e. Remove the applicator pad from the packet.

f. Discard the empty packet, observing litter discipline.

g. Open the applicator pad.

(1) Unfold the applicator pad.

(2) Slip your finger(s) into the handle.

h. Thoroughly scrub exposed skin on the back of your hand, palm, and fingers until completely covered with black powder from the applicator pad.

i. Switch the applicator pad to the other hand, repeating the previous step on the other hand.

WARNING

Death or injury may result if you breathe toxic agents while decontaminating the face. If you need to breathe before you finish, reseal your mask, clear it, and check it. Get your breath, then resume the decontaminating procedure.

j. Decontaminate your face and the inside of your mask.

(1) Hold your breath.

(2) Close your eyes.

(3) Grasp the mask beneath your chin.

(4) Pull the hood and mask away from your chin enough to allow one hand between the mask and your face.

(5) Wipe up and down across your face, beginning at the front of one ear to your nose to other ear.

(6) Wipe across your face to the corner of your nose.

(7) Wipe extra strokes at the corner of your nose.

(8) Wipe across your nose and the tip of your nose to the other corner of your nose.

(9) Wipe extra strokes at the corner of your nose.

(10) Wipe across your face to the other ear.

(11) Wipe up and down across your face, beginning from the ear to your mouth to other end of the jawbone.

(12) Wipe across your cheek to the corner of your mouth.

(13) Wipe extra strokes at the corner of your mouth.

(14) Wipe across your closed mouth to the center of your upper lip.

(15) Wipe extra strokes above your upper lip.

(16) Wipe across your closed mouth to the other corner of your mouth.

(17) Wipe extra strokes at the corner of your mouth.

(18) Wipe across your cheek to the end of your jawbone.

(19) Wipe up and down across your face, beginning from your jawbone, to your chin and to the other end of your jawbone.

(20) Wipe across and under your jaw to your chin, cupping your chin.

(21) Wipe extra strokes at the center of your chin.

(22) Wipe across and under your jaw to end of your jawbone.

(23) Decontaminate the inside of your mask by turning your hand out and quickly wiping the inside of the mask that touches your face.

(24) Discard the applicator pad, employing litter discipline.

(25) Seal your mask.

(26) Clear your mask.

(27) Check your mask.

(28) Breathe.

k. Remove the second packet from the carrying pouch.

l. Tear open the packet quickly at the notch.

m. Remove the applicator pad from the packet.

n. Discard the empty packet, employing litter discipline.

o. Open the applicator pad.

(1) Unfold the applicator pad.

(2) Slip your finger(s) into the handle.

p. Scrub thoroughly the skin of your neck and ears without breaking the seal between your face and the mask until they are completely covered with black powder.

q. Redo your hands until they are completely covered with black powder.

r. Discard the applicator pad, employing litter discipline.

s. Put on your protective gloves.

t. Fasten the hood.

u. Remove the powder with soap and water when operational conditions permit.

NOTE: It does not matter how long the powder stays on your skin.

**DECONTAMINATE YOUR INDIVIDUAL
EQUIPMENT USING THE M295 INDIVIDUAL
EQUIPMENT DECONTAMINATION KIT (IEDK)
031-503-1034**

CONDITIONS

You are at Mission-Oriented Protective Posture (MOPP) level 4 with Kevlar helmet, load carrying equipment (LCE), mask carrier and assigned weapon. You have just completed skin decontamination. You have an M295 IEDK and you find yourself in one of the following situations where you have:

1. Been attacked with chemical agents.
2. Passed through an area contaminated with chemical agents.

STANDARDS

Decontaminate all your individual equipment for liquid decontamination using the M295 IEDK without getting the powder in your eyes, cuts, or wounds or contaminating yourself.

TRAINING AND EVALUATION

Training Information Outline

CAUTION

Keep decontaminating powder out of your eyes, cuts, and wounds by not:

1. Handling or holding leaking packets above the head.
2. Touching or rubbing your eyes with anything that has been in contact with the decontaminating powder (hands, arms, clothing, equipment).
3. Touching your lips or inside your mouth with anything that has been in contact with the decontaminating powder (hands, arms, clothing, equipment).

CAUTION

Cover exposed cuts or wounds with appropriate first aid wrap or bandage prior to handling the packets.

1. Inspect the IEDK.

a. Check for loose black (decontaminating) powder.

(1) If no powder is detected, the kit is ready.

(2) If powder is detected, inspect each packet for leaks.

(3) Discard all leaking packets.

b. Verify that there are at least four decontaminating packets in the kit.

NOTE: If there are fewer than four decontaminating packets in the kit, request an additional kit.

2. Use the IEDK.

a. Prepare the IEDK.

(1) Remove one decontaminating packet from the kit.

(2) Tear the packet at a notched edge.

(3) Remove the pad applicator mitt.

(4) Discard the foil packet, employing litter discipline.

(5) Open the pad applicator mitt.

(a) Unfold the pad applicator mitt.

(b) Grasp the outside of the pad applicator mitt.

b. Decontaminate the glove for the hand with which you write.

c. Put on the decontaminated glove.

d. Insert the decontaminated gloved hand inside the pad applicator mitt, placing the resin pad in the palm side of the hand.

e. Decontaminate your individual equipment by rubbing with the resin pad side of the pad applicator mitt, making sure you cover all areas thoroughly, especially areas which are hard to get into (e.g., cracks, crevices and other absorbent material). Decontaminate the following:

(1) Your other protective glove.

(2) Exposed areas of the mask and hood.

(3) Your weapon.

(4) Your helmet by patting the pad applicator mitt on the surface.

CAUTION

Never attempt to decontaminate a loaded weapon. Always unload, clear, and place weapons on safe before starting decontaminating procedures.

- f. Discard the pad applicator mitt, employing litter discipline.
- g. Get another packet.
- h. Decontaminate the remainder of your individual equipment with the new packet.
 - (1) LCE and accessories (for example, canteen, ammo pouch, first aid pouch, and so forth).
 - (2) Mask carrying case.
 - (3) Protective boots.
- i. Repeat decontamination of the protective gloves.
- j. Discard the pad applicator mitt, employing litter discipline.
- k. Use another pad applicator mitt to decontaminate any areas where liquid agent is still suspected or detected.
- l. Repeat decontamination of the protective gloves.
- m. Discard the pad applicator mitt, employing litter discipline.

CAUTION

Only the liquid hazard has been removed. Items may still present a vapor hazard. Do not unmask until items have undergone complete decontamination or have been determined by appropriate detector (for example, chemical agent monitor [CAM]) to ensure no vapor hazards are present.

SECTION VII

FIRST AID

This section includes eleven GIVE FIRST AID tasks from STP 21-1-SMCT.

EVALUATE A CASUALTY

081-831-1000

CONDITIONS

In a tactical environment, given a soldier who has signs and/or symptoms of an injury.

STANDARDS

Evaluate a casualty and identify all injuries and/or conditions so that proper aid is rendered.

TRAINING AND EVALUATION

Evaluation Preparation

Setup: You will need another soldier to play the part of the casualty. Have the casualty lie down, face-up. Soldier

number two will practice the evaluation procedure on soldier number one, simultaneously with the facilitator's talk-through.

Brief Soldier: You have just come upon a soldier who is lying face-up and is not moving. At the signal, you will simulate the steps for evaluating a casualty.

Training Information Outline

NOTES: 1. When evaluating and/or treating a casualty, you should seek medical aid as soon as possible. Do not stop treatment, but if the situation allows, send another person to find medical aid.

2. If there are any signs of chemical or biological agent poisoning, immediately mask the casualty. If it is not nerve agent poisoning, decontaminate exposed skin and gross contamination (large wet or oily spots) of the clothing or overgarments. If it is nerve agent poisoning, administer the antidote before decontamination. (See the task Perform First Aid For Nerve Agent Injury [Buddy-Aid], task number 081-831-1044.)

WARNING

If a broken neck or back is suspected, do not move the casualty unless to save his or her life.

1. Check for responsiveness.
 - a. Ask in a loud, but calm voice, "Are you okay?"

- b. Gently shake or tap the casualty on the shoulder.
 - c. Watch for a response. If the casualty does not respond, go to step 2.
2. If the casualty is conscious, ask where he or she feels different than usual or where it hurts. Go to step 3.

NOTE: If the casualty is conscious but is choking and cannot talk, stop the evaluation and begin first aid. Appropriate first aid action is in the lesson “Perform First Aid to Clear an Object Stuck in the Throat of a Conscious Victim.”

3. Check the Casualty’s Breathing.

a. Breathing is checked using the following methods.

(1) Look for a rise and fall of the casualty's chest.

(2) Listen for breathing by placing your ear about 1 inch above the casualty's mouth and nose.

(3) Feel for breathing by placing your hand or cheek about 1 inch above the casualty's mouth and nose.

b. If casualty is not breathing, call for medical help and begin first aid. Appropriate first aid actions are in the lessons “Perform First Aid to Clear an object Stuck in the Throat of a Conscious Victim” and “Perform Mouth-to-Mouth Resuscitation.”

WARNING

In a chemically contaminated area, do not expose the wound(s).

4. Check the Casualty for Bleeding.
 - a. Look for spurts of blood or blood-soaked clothes.
 - b. Look for entry and exit wounds.
 - c. If bleeding is present, begin first aid.

Appropriate first aid actions, as needed, are in these lessons: “Perform First Aid for Bleeding of an Extremity,” “Perform First Aid for an Open Head Wound”, “Perform First Aid for an Open Chest Wound,” and “Perform First Aid for an Open Abdominal Wound.”

(1) Arm or leg wound: See task Perform First Aid for Bleeding of an Extremity, task number 081-831-1032.

(2) Partial or complete amputation: See task Perform First Aid for Bleeding of an Extremity, task number 081-831-1032.

(3) Open head wound: See task Perform First Aid for an Open Head Wound, task number 081-831-1033.

(4) Open abdominal wound: See task Perform First Aid for an Open Chest Wound, task number 081-831-1026.

(5) Open chest wound: Apply A Dressing To An Open Chest Wound.

5. Check the Casualty for Shock.

a. Look for any of the following signs and/or symptoms.

(1) Sweaty but cool skin (clammy skin).

(2) Paleness of the skin.

(3) Restlessness or nervousness.

(4) Thirst.

(5) Loss of blood (bleeding).

(6) Confusion.

(7) Faster than normal breathing rate.

(8) Blotchy or bluish skin, especially around the mouth.

(9) Nausea and/or vomiting.

b. If signs/symptoms of shock are noted, begin first aid. Appropriate first aid action can be found under the task “Perform First Aid to Prevent or Control Shock.”

6. Check the Casualty for Fractures.

a. Look for the following signs and/or symptoms of a back or neck injury.

(1) Pain or tenderness of the neck or back area.

(2) Cuts or bruises in the neck or back area.

(3) Inability of a casualty to move (paralysis or numbness).

a. Ask about the ability to move (paralysis).

b. Touch the casualty's arms and legs and ask whether he or she can feel your hand (numbness).

(4) Unusual body or limb position.

WARNING

Unless there is immediate life-threatening danger, do not move a casualty who has a suspected back or neck injury.

b. Immobilize any casualty suspected of having a neck or back injury by doing the following:

(1) Tell the casualty not to move.

(2) If a back injury is suspected, place padding under the natural arch of the casualty's back.

(3) If a neck injury is suspected, place a roll of cloth under the casualty's neck and put boots (filled with dirt, sand, etc.) or rocks on both sides of the head.

c. Check the casualty's arms and legs for open or closed fractures.

(1) Check for open fractures. Look for bleeding or bone sticking through the skin.

(2) Check for closed fractures. Look for swelling, discoloration, deformity, or unusual body position.

(3) If casualty has a closed or open fracture, begin first aid. Appropriate first aid action is in the lesson "Perform First Aid for a Suspected Fracture."

7. Check the Casualty for Burns.

a. Look carefully for reddened, blistered, or charred skin. Also check for singed clothes.

b. If burns are found, begin first aid. Appropriate first action is in the lesson: "Give First Aid for Burns."

8. Check the Casualty for a head injury.

a. Usually, serious skull fractures and brain injuries occur together; however, it is possible to receive a serious brain injury without a skull fracture. The brain is a very delicate organ; when it is injured, the casualty may exhibit a number of signs and/or symptoms.

b. Look for the following signs and symptoms.

(1) Unequal pupils (the pupils of the eyes are not the same size).

(2) Fluid from the ear(s), nose, mouth, or injury site.

(3) Slurred speech.

(4) Confusion.

(5) Sleepiness.

(6) Loss of memory or consciousness.

(7) Staggering in walking.

(8) Headache.

(9) Dizziness.

(10) Vomiting.

(11) Paralysis.

(12) Convulsions or twitches.

c. If a head injury is suspected, continue to watch for signs which would require performance of mouth-to-mouth resuscitation (see task Perform Mouth-to-Mouth resuscitation, task number 081-831-1042), treatment for shock (see task Perform First Aid to Prevent or Control Shock, task number 081-831-1005), or control of bleeding (see task Perform First Aid for Bleeding of an Extremity, task number 081-831-1032).

9. Seek medical aid. Seek medical assistance as soon as possible, but you must not interrupt treatment. If possible send another person to find medical aid.

REFERENCES

FM 21-11

PERFORM FIRST AID TO RESTORE BREATHING

**008-831-1003 Perform First Aid to Clear an Object
Stuck in the Throat of a Conscious Casualty**
008-831-1042 Perform Mouth-to-mouth Resuscitation

CONDITIONS

In a tactical environment, and given a conscious or unconscious casualty who has stopped or is having difficulty in breathing.

STANDARDS

Be able to administer first aid until the casualty can talk and breathe normally or until you are relieved by a qualified person.

TRAINING AND EVALUATION

Evaluation Preparation

Setup: You will need Resusci-Anne to play the part of the casualty. Have the casualty lie down, face-up. Soldier will practice the evaluation procedure on Resusci-Anne, simultaneously with the facilitator's talk-through.

Brief Soldier: Describe the symptoms of a casualty with good air exchange, poor air exchange, or a complete airway obstruction. Ask the soldier what should be done. Score step 1 based upon the answer. Then tell the soldier to do all of the first aid steps required to clear an object from the casualty's throat. Tell the soldier to demonstrate where to stand, how to position his or her hands, and how to position the casualty for the thrusts. The soldier must tell you how the thrusts should be done. Ensure that the soldier understands that he or she must not actually do the thrusts. Do not evaluate step 3 in the simulated mode.

Evaluation Guide

Performance Measures

1. Obstructions to the Airway. An upper airway obstruction is any object in the throat that blocks breathing. If the obstruction is not removed, unconsciousness and death will result. Here are examples of obstruction:

- a. Foreign objects such as food or other materials.

b. Blood clots or loose teeth caused by head or facial injuries.

c. The casualty's own tongue falling back into his throat. Immediate help is needed. Evaluation of the casualty, is to be performed prior to administering mouth-to-mouth resuscitation.

2. Perform First Aid to Clear an Object Stuck in the throat of a Conscious Casualty.

a. Evaluate the casualty.

(1) Check for universal choking sign.

(2) Ask if he can speak.

(3) Listen for coughing sounds or wheezing noises.

(4) Check for lack of breathing.

NOTE: If the conscious victim has signs of airway obstruction, immediate action is essential. If the casualty has good air exchange with only partial obstruction and is able to speak or cough, do not interfere with his attempts to expel a foreign body.

NOTE: Clearing a conscious casualty's airway obstruction can be performed with the casualty either standing or sitting and by following a relatively simple procedure. If the person has poor air exchange or complete blockage, call for help and begin administering manual (abdominal or chest) thrusts.

NOTE: Do not use abdominal thrusts on anyone who is in the advanced stages of pregnancy, is obese, or who has a significant abdominal wound. Use chest thrust in the preceding situations.

b. Deliver abdominal thrusts.

(1) Position yourself behind the casualty and wrap arms around the casualty's waist.

(2) Make a fist with one hand and place thumb side of the fist against the abdomen slightly above the navel and well below the tip of the breastbone. Cover the fisted hand with the other hand.

(3) Give quick backward and upward thrusts.

c. If an abdominal thrust is not possible, deliver chest thrusts.

(1) Position yourself behind the casualty and wrap arms around the casualty's chest.

(2) Make a fist with one hand and place the thumb side of the fist on the middle of the breastbone. Cover the fisted hand with the other hand.

(3) Give quick backward and upward thrusts.

NOTE: Continue performing abdominal thrusts until the obstruction is expelled or the casualty becomes unconscious. If the casualty becomes unconscious, perform a finger sweep and then start mouth-to-mouth

resuscitation procedures. If the obstruction is cleared, watch the casualty closely and check for other injuries if necessary (see task Evaluate a Casualty task number 081-831-1000).

3. Clear the Airway of an Unconscious Casualty.

a. Call for help.

b. Place casualty on his back, straddle or kneel near the hips, and place one hand on top of the other in the middle of the abdomen (fingers pointing towards the head).

c. Continue giving abdominal or chest thrusts, as required.

d. Open the mouth by grasping the teeth, and then with the thumb and index finger, lift the jaw open.

e. Look into the mouth and apply a finger sweep. To do this, the index finger of the other hand is inserted along the inside of one cheek. Use a hooking motion from the far side of the mouth to the near side.

CAUTION

If the casualty vomits roll him onto his side away from you.

NOTE: Continue performing abdominal thrusts until the obstruction is expelled, or a qualified person has relieved you.

4. Perform Mouth-to-Mouth Resuscitation.

a. Roll the casualty on his or her back if necessary.

b. Emergency procedures must be applied to a casualty quickly and correctly. In order for the soldier to apply the correct procedure, the casualty must be in the proper position. Procedures of this step are:

(1) Check for responsiveness. Establish whether the casualty is conscious by gently shaking him or her and asking, "Are you OK?"

(2) Call for help.

(3) Position the unconscious casualty up on a firm surface.

(4) Straighten the casualty's legs. Take the casualty's arm that is nearest to you. Move it so that it is straight and above his or her head. Repeat the procedure with the other arm.

(5) Kneel beside the casualty with your knees near his or her shoulders (leave space to roll the body). Place one hand behind the head or neck for support. With your other hand grasp the casualty under the far arm (armpit area).

(6) Roll the casualty towards you using a steady and even pull. The head and neck should stay in line.

(7) Return the casualty's arms to his or her side. Straighten the casualty's legs. Reposition yourself so that you are now kneeling at the level of the casualty's shoulders. If a neck injury is suspected and the jaw thrust will be used, kneel at the casualty's head looking at the feet.

c. Open the airway using the head-tilt/chin-lift method. The tongue is the single most common cause of an airway obstruction. In most cases, the airway can be cleared by simply extending the neck. This action pulls the tongue away from the air passage in the throat. This procedure is called the head-tilt/chin-lift method.

(1) Kneel at the level of the casualty's shoulders.

(2) Place one hand on the casualty's forehead and apply firm, backward pressure with the palm to tilt the head back.

(3) Place the fingertips of the other hand under the bony part of the lower jaw and lift, bringing the chin forward.

NOTE: Do not use the thumb to lift and do not press deeply into the soft tissue under the chin with the fingers. Ensure the students understand that foreign material should be removed as soon as possible.

d. Check for breathing within three to five seconds by placing an ear over the casualty's mouth and looking toward his or her chest.

NOTE: After establishing an open airway, it is important to maintain that airway in an open position. Often the act of just opening and maintaining the airway will allow the casualty to breathe properly. Once the rescuer uses the head-tilt/chin-lift method to open the airway, he or she should maintain that head position to keep the airway open. Failure to maintain the open airway will prevent the casualty from receiving an adequate supply of oxygen. The procedures for this step are:

- (1) LOOK for the chest to rise and fall.
- (2) LISTEN for air escaping during exhalation by placing your ear near the casualty's mouth.
- (3) FEEL for the flow of air on your cheek.

NOTE: If the casualty resumes breathing at any time during this procedure, the airway should be maintained open and the casualty should be monitored. If the casualty continues to breathe, he or she should be transported to medical aid.

e. Give breaths to ensure an open airway.

(1) If the chest does not rise and fall and no air is exhaled, the casualty is breathless. This is a sign for you to begin mouth-to-mouth resuscitation. In this method of rescue breathing, inflate the casualty's lungs with air from your lungs.

a. Maintain the airway and gently pinch the nose closed using the hand on the casualty's forehead.

i. Let the same hand, pinching the nose closed, exert pressure on the casualty's forehead to maintain the backward head tilt and maintain an open airway.

ii. With the other hand, lift the chin while keeping your fingertips on the bony part of the lower jaw near the chin.

b. Take a deep breath and place your mouth, in an airtight seal, around the casualty's mouth.

c. Give two full breaths (one and one-half to two seconds each), taking a breath between them, while watching for the chest to rise and fall and listening and/or feeling for air to escape during exhalation.

(2) If the chest rises, go to "Check for Pulse". If the chest does not rise, continue with "Reposition the casualty's head slightly farther backward and repeat the breaths."

NOTE: The mouth-to-nose method is recommended when the casualty's mouth cannot be opened, there are jaw or mouth injuries, or a tight seal cannot be formed around the casualty's mouth.

f. Reposition the casualty's head slightly farther backward and repeat the breaths.

(1) Improper chin and head positioning is the most common cause of difficulty with ventilation. If the

initial attempt to ventilate the casualty is unsuccessful, reposition the casualty's head and repeat rescue breathing. The procedures of this step are as follows:

- a. Reposition the casualty's head slightly backward.
- b. Repeat the steps in "Give breathes to ensure an open airway."

(2) If the chest rises, go to "Check for a pulse." If it does not rise, continue with "Perform abdominal or chest thrusts."

5. Perform a finger sweep and repeat the breaths.

a. If you cannot administer rescue breathing due to an airway obstruction, then remove the airway obstruction using the finger sweep method.

b. Procedures of the finger sweep method include the following:

(1) Open the casualty's mouth by grasping both the tongue and lower jaw between your thumb and fingers and lifting the jaw open.

NOTE: If you are unable to open the casualty's mouth, cross your fingers and thumb and push the teeth apart by pressing your thumb against his or her upper teeth and pressing your fingers against the lower teeth.

(2) Insert the index finger of the other hand down along the cheek to the base of the tongue.

(3) Use a hooking motion from the side of the mouth toward the center to dislodge the object. Take care not to force the object deeper into the airway.

(4) Reopen the airway and repeat the breaths.

NOTE: If the chest rises, go to “Check for pulse.” If the chest does not rise, repeat steps “Perform abdominal thrusts or chest thrusts.” And “Perform a finger sweep and repeat breaths” until airway is clear.

6. Check for a pulse.

a. When a casualty’s heart has stopped, he or she is unconscious and limp; the pupils of the eyes are open wide. When evaluating a casualty or when performing the preliminary steps of rescue breathing, feel for a pulse.

b. Checking for a pulse requires the following steps:

(1) Use the first two fingers in the groove in the casualty’s throat beside the Adam’s apple.

(2) Without using the thumb, check pulse for 5 to 10 seconds.

c. If a pulse is found but the casualty is not breathing, continue mouth-to-mouth resuscitation. If no pulse is found, cardiopulmonary resuscitation (CPR) must be performed by qualified personnel. Send for qualified medical personnel.

7. Continue Mouth-to-Mouth.

a. You as a lifesaving agent would continue rescue breathing until the casualty starts to breathe on his or her own, until you are relieved by another person, or until you are too tired to continue.

b. Continuation of lifesaving procedures involves the following:

(1) Continue mouth-to-mouth resuscitation at the rate of about 10 to 12 breaths per minute.

(2) Recheck for pulse and breathing for three to five seconds every 12 breaths.

(3) Continue mouth-to-mouth or mouth to nose resuscitation until breathing is restored.

8. In a real emergency situation, the care giver would watch the casualty closely, would maintain an open airway, and would check for other injuries.

REFERENCES

DVC 08-14
SO830

FM 21-11
STP 21-1-SMCT

PERFORM FIRST AID TO CONTROL BLEEDING

081-831-1032 Perform First Aid for Bleeding of an Extremity

081-831-1033 Perform First Aid for an Open Head Wound

081-831-1026 Perform First Aid for an Open Chest Wound

081-831-1025 Perform First Aid for an Open Abdominal Wound

CONDITIONS

In a tactical environment, under any conditions; given a casualty who appears to have an open wound.

STANDARDS

Be able to control the bleeding and to apply a dressing to the open wound following the correct sequence without causing further injury to the casualty.

TRAINING AND EVALUATION

Evaluation Preparation

Setup: Soldiers will be divided up into buddy-teams. One soldier in each pair will simulate being a casualty and the other soldier will simulate rendering first-aid. Upon completion, soldiers will reverse roles. Each buddy-team will be issued field dressings, improvised field dressing and padding material (t-shirts, socks, strips of cloth, handkerchiefs, etc.), rigid stick-like objects, and grease pencils.

Brief Soldier: You observe a casualty with a bleeding wound to an extremity (either an arm or leg). You are not in a chemical environment.

Evaluation Guide

Performance Measures

1. Put on a Field Dressing

a. As with all first aid tasks, before applying a dressing, evaluate the casualty, checking the entire body for other injuries and taking other lifesaving measures as necessary (Task #081-831-1000, Evaluate a Casualty).

b. If at all possible, expose the wound first, by pushing or cutting away loose clothing. This will enable you to view the extent of the injury.

WARNING

Clothing or anything else stuck to the wound should be left alone to avoid injury. Do not attempt to clean the wound.

NOTE: Important to Remember: If you are in an area where chemical agents have been released, do not expose the wound. Place the dressing on the wound and secure in place.

c. Remove the dressing packet from the first aid pouch of the casualty.

d. Grasp olive drab tails of the dressing with two hands.

e. Hold the dressing directly over the wound with white side down.

f. Pull the dressing open and place directly over the wound, white side down.

g. With one hand, hold the dressing in place; use the other hand to wrap one of the tails around the injury.

NOTE: If the casualty is able, you may ask him to hold the dressing in place while you wrap the tails.

h. Wrap the other tail in the opposite direction until remainder of dressing is covered and secured to the body.

NOTE: Tie the tails into a nonslip knot over the outer edge of the dressing. The field dressing knot is never tied over the wound.

CAUTION

Dressing should be tied firmly enough to secure the dressing but loosely enough to insert 2 fingers between the knot and the dressing.

NOTE: When practical, apply direct manual pressure over the dressing for 5-10 minutes to help control the bleeding. The casualty can be asked to do this himself, if he is conscious and can follow instructions.

i. After you have applied the field dressing to the injury, elevate the injured extremity above the level of the heart to lessen the bleeding. A blanket, shelter half, poncho, log, or any other available material, can be used to elevate the injury.

NOTE: If a fracture is suspected and it is not splinted, do not elevate the injured part.

2. Put on a Pressure Dressing

a. If the bleeding continues, it may be necessary to apply an improvised pressure dressing. What is a pressure dressing? A pressure dressing consists of these parts:

(1) Any bulky material which can be folded several times, (a rag, a piece of soldier's garment) and placed on top of the original dressing.

(2) Strips of cloth torn from a garment, socks, or other material which is then wrapped around the padded material to secure it in place.

NOTE: Keep injured extremity elevated.

b. Apply a pressure dressing by performing the following procedures:

(1) Place a wad of padding directly over the simulated wound and on top of the original dressing.

(2) Place an improvised dressing over the wad of padding and wrap it tightly around the limb.

(3) Tie the ends in a nonslip knot directly over the simulated wound to secure the extra padding.

(4) Check to make sure that the dressing is tight enough so that only the tip of one or two fingers can be inserted between the dressing and the knot. The pressure dressing should not have a tourniquet-like affect. It must be loosened if the skin beyond the injury becomes cool, blue, or numb.

c. If the bleeding stops, watch the casualty closely for life-threatening conditions and check other injuries, if necessary. If the bleeding continues, you might have to apply a tourniquet.

3. Application of a Tourniquet

a. Use of tourniquet:

(1) If the bleeding continues, or if the wound is a partial or complete amputation of the arm or leg, you will need to apply a tourniquet on the injured extremity. A soldier whose arm or leg has been completely amputated may not be bleeding when first discovered, but a tourniquet should be applied anyway.

(2) This absence of bleeding is due to the body's normal defenses (contraction of blood vessels) as a result of the amputation, but after a period of time, bleeding will start, as the blood vessels relax.

b. Define tourniquet: It is a constricting band of material placed around an arm or leg to stop severe

bleeding. This band is improvised from a strip of cloth or handkerchief. For training purposes, a cravat (tie) will be used.

c. Precautions:

(1) Use a tourniquet only when all other measures (i.e., direct pressure on the wound and elevation) fail to control bleeding.

(2) Do not use wire or shoestrings for a tourniquet band.

(3) A tourniquet is used only on arm(s) or leg(s) where there is danger of loss of casualty's life or limb.

(4) Once a tourniquet has been applied, DO NOT adjust, loosen, or remove it.

d. Procedures for Putting on a Tourniquet

(1) Prepare a tourniquet.

a. Improvise bandage from handkerchief, strips of cloth, or other strong, pliable material; fold it into a band not less than 2 inches wide.

b. Obtain a rigid, stick-like object. For training purposes you will use a towel. In a real situation it may become necessary to improvise (e.g., tree limb).

(2) Place the tourniquet.

a. Place the tourniquet 2 to 4 inches above the wound and between the wound and the heart.

b. If the wound is just below the elbow or below the knee, the tourniquet should be applied above and as close to the joint as possible.

NOTE: The tourniquet should not be placed on a joint or over the wound. When possible, place the tourniquet over the casualty's sleeve or trouser leg to prevent further injury.

c. Tie a half-knot. (A half-knot is the same as the first part of tying a shoelace.)

d. Place the rigid object (e.g., stick) on top of the half-knot.

e. Tie a full knot over the stick.

f. Twist the stick.

(3) Secure the stick, using the ends of the tourniquet band or another piece of cloth, so that the stick does not unwind and the casualty is not injured further.

CAUTION

Do not cover tourniquet—leave it in full view.

NOTE: If the extremity is missing, apply the tourniquet first to stop the bleeding, and then pad and bandage the

stump using whatever improvised bandaging materials are available (e.g., shirts, strips of cloth).

(4) Mark the casualty's forehead with a "T" to indicate a tourniquet is in place.

(5) Get medical help.

4. Apply a dressing to an Open Head Wound

a. Background Information

(1) Open injuries: a visible wound, usually bleeding from the scalp or head, with brain matter possibly exposed requires first aid.

(2) Possible signs and symptoms:

- a. Bleeding from scalp/head area.
- b. Deformity of head.
- c. Clear or bloody fluid leaking from nose or ears.
- d. Black eyes.
- e. Loss of consciousness.
- f. Confusion.
- g. Headache.

- h. Eye (vision) problems.
- i. Breathing problems.
- j. Convulsions (involuntary jerking and shaking).
- k. Applying a Dressing to an Open Head Wound

b. Applying the dressing

(1) Determine level of consciousness by asking casualty his name, the date, and the place, etc.

(2) Report incorrect answers, inability to answer, or changes in answers to medical personnel. Check the casualty's level of consciousness every 15 minutes and note any changes from earlier observations.

(3) Protect casualty who is having convulsions from self-injury.

a. Ease casualty to the ground.

b. Support the head until the convulsion ends.

(4) Position the casualty

NOTE: Do not move the casualty if you suspect that he or she has sustained a neck, spine, or severe head injury which produces any signs or symptoms other than minor

bleeding (see task Evaluate a Casualty, task 081-831-1000).

- a. Have a conscious casualty sit up unless other injuries prohibit that position.
- b. Raise the casualty's head slightly if he or she is lying down and is not accumulating fluids in the throat. The best position for a casualty with a simple injury is with the head slightly elevated.
- c. Turn the casualty's head to the side opposite the wound if the wound is bleeding into the mouth or throat.
- d. Treat an unconscious casualty as having a potential neck or spinal injury. Immobilize and do not move the casualty unless absolutely necessary.
- e. Turn an unconscious casualty onto his or her side opposite the wound with the head turned to one side and supported on his or her hands.
- f. If it is necessary to turn a casualty with a suspected neck or spinal injury, assistance will be required to roll the casualty gently onto his or her side while keeping the head, neck, and body aligned and providing support for the head and neck.

(5) Expose wound by removing helmet, if necessary.

WARNING

Do not push brain matter into skull; do not clean the wound or put pressure on it. If the ear is draining clear pink fluid place dressing/cloth over the ear.

WARNING

In a chemical environment in which the “all-clear” has not been given, do not remove mask and hood to apply dressing. Try to repair a break in the headgear with tape or wet cloth. Only if the “all clear” is given can you remove headgear to apply dressing.

(6) Apply dressing. Wound location determines method of wrapping the dressing. (See Task 081-831-1016, “Put on a Field or Pressure Dressing.”)

- a. Wound to forehead or back of head.
 - i. Apply the dressing, white side down, directly over the wound with the tails extending toward the sides of the head.
 - ii. Wrap one tail horizontally around the head.
 - iii. Wrap remaining tail in opposite direction, while holding first tail in place.

NOTE: Make sure eyes and ears are not covered.

iv. Tie the tails at the side of the head, with a nonslip knot, securing the edge of the dressing.

b. Wound to top of head.

i. Apply dressing, white side down over wound.

ii. Wrap one tail down under the chin and bring it up in front of the ear over the dressing to a point just above and in front of the opposite ear.

iii. Wrap the other tail down under the chin in the opposite direction and up the side of the head to meet the first tail.

iv. Cross the tails, bringing one to the front of the forehead above the eyebrows just above and in front of the opposite ear.

v. Wrap the second tail above the ear and in back of the head to meet the first tail. Tie with a nonslip knot. **NOTE:** If at all possible, avoid covering the ears, to allow the casualty to hear.

c. Wound to the cheek or the side of the head.

i. Position the field dressing over wound.

ii. Wrap one tail over the top of the head down in front of the ear, under the chin, and up over the dressing to a point just above the ear.

iii. Wrap the other tail under the chin and over the head to meet the first tail.

iv. Cross the tails and complete the procedures as follows:

v. Wrap one tail across the forehead above the eyebrows to a point just above and in front of the opposite ear.

vi. Wrap the other tail above the ear, lower over the back of the head, and above the opposite ear to meet the other tail.

vii. Tie the tails using a nonslip knot.

CAUTION

Casualty's head needs to be elevated slightly higher than the heart to reduce bleeding.

NOTE: Do not give casualty anything to eat or drink. Monitor every 15 minutes and awaken if asleep.

(7) Notify medical personnel.

5. Apply a dressing to an Open Chest Wound

a. Background Information

(1) Chest injuries may result from these agents:

a. Bullet or missile wounds.

- b. Stab wounds.
- c. Falls and blows.

(2) Sucking sound.

- a. Caused by air leaking into punctured chest wall.
- b. Puncture results in great difficulty breathing.
- c. Requires **rapid** action to seal wound and apply dressing.

(3) Possible Signs and Symptoms:

- a. Pain in chest or shoulder area.
 - b. Increased pain/difficulty breathing.
 - c. Shortness of breath.
 - d. Chest not rising normally when breathing.
 - e. Coughing blood.
 - f. Rapid or weak pulse.
 - g. Bluishness around lips, fingernails/fingertips.
- b. Apply a Dressing to an Open Chest Wound

- (1) Locate and expose wound(s).
 - a. Check for entry and exit wound(s).
 - i. Look for pool of blood under casualty.
 - ii. Feel for wounds.
 - b. Listen for sucking sounds to determine if chest wall has been punctured.
 - c. Cut or remove clothing to expose wound, if possible. In a chemical environment do uncover the wound until the all clear is given.

CAUTION

Do not remove any object extending from wound. Improvise bulky dressing from cleanest material available to build up area around object. No attempt should be made to clean a wound before applying the wrapper and dressing.

- (2) Apply plastic wrapper to wound.
 - a. Tear open the wrapper of casualty's dressing to create a flat surface.
 - b. Place the inside surface directly over the wound as casualty exhales.
 - c. Hold in place until dressing is applied to maintain air tight seal.

- (3) Apply dressing to both entry and exit wounds.
 - a. Use casualty's dressing for one wound.
 - b. Improvise seal and dressing for second wound (e.g., folded poncho, cellophane, foil as seal; cloth strips as dressing).
 - c. Using the free hand, shake open the dressing. Place the white side directly over the plastic covering the wound, holding it securely in place to create an airtight dressing.
 - d. Have casualty breathe normally.
 - e. Maintain pressure on the dressing while wrapping the first tail of the dressing under the body with one hand.
 - f. Continue to maintain pressure on the dressing while wrapping the other tail under the body, returning to the starting point, and grasping both tails.
 - g. Tie the tails into a nonslip knot over the center of the dressing while casualty exhales (or when chest falls, if unconscious).

(4) Position casualty on injured side or in a sitting position, whichever makes breathing easier.

- a. If the casualty's condition (difficulty in breathing, shortness of breath, restlessness, or blueness of

skin) worsens after placing the dressing, the caregiver should quickly lift or remove and then replace the airtight dressing.

b. In a real situation, the casualty should be watched closely for life-threatening conditions and that he or she should be checked for other injuries. In a real-world situation, the aidman should also seek medical aid for the casualty.

(5) Seek Medical Aid.

6. Apply a dressing to an open abdominal wound.

a. Background Information

(1) Open abdominal injuries are those in which a foreign object has entered the abdomen, such as in a stab or bullet wound.

(2) Open wounds will bleed severely due to the large blood vessels located in the abdomen.

(3) Death can occur rapidly with this type of wound. Ensure that medical help is sought immediately.

b. Apply a dressing to an open abdominal wound

(1) Position casualty on his back with knees up, to prevent further exposure of the bowels.

(2) Expose wound by cutting/pushing loose clothing.

CAUTION

Do not attempt to remove clothing that is stuck to the wound; This may cause further injury. Do not uncover the wound in a chemical environment.

(3) Gently pick up any organs which may be on the ground, with a clean dressing, and place them on top of the casualty's abdomen. If there is an object extending from the wound, do not remove it. Place as much of the plastic wrapper from the dressing as possible, sterile side down, over the wound without dislodging or moving the object. Do not place the wrapper over the protruding object.

WARNING

Do not: touch exposed organs with hands; probe, clean or remove foreign objects; push organs back inside body.

(4) Apply the dressing.

- a. Apply the casualty's dressing by grasping tails with two hands.
- b. Hold dressing directly over wound, white side down, pull open, and place over wound. Cover any organs placed on the casualty's abdomen when applying the field dressing.
- c. With one hand, hold dressing in place; with the other, wrap one tail around the casualty. While

holding the dressing or wrapping the wound, do not apply pressure to the wound or other exposed internal parts.

- d. Wrap the other tail in the opposite direction until dressing is covered.
 - e. Tie the tails in nonslip knot over the outer edge.
 - f. Keep casualty's knees up.
- (5) Notify medical personnel immediately.

REFERENCES

FM 21-11 SO616
SO821 STP 21-1-SMCT

PERFORM FIRST AID FOR TREATMENT OF BURNS 081-831-1007

CONDITIONS

Given a casualty who is suffering from a burn. A canteen and first aid packet are available.

STANDARDS

Give first aid for a burn without causing further injury to the casualty.

TRAINING AND EVALUATION

Evaluation Preparation

Brief Soldier: Before giving first aid for burns evaluate the

casualty (Task #081-831-1000, “Evaluate a Casualty”). Once you have determined that the casualty has a burn, you must determine the type of burn.

Evaluation Guide

Performance Measures

1. Types of Burns

a. Thermal burns: caused by contact with fire, hot objects, hot liquids, gases, or nuclear blast fireball.

b. Electrical burns: caused by contact with bare electrical wires, current, or lightning.

c. Chemical burns: caused by contact with wet or dry chemicals and/or white phosphorus.

d. Laser burns.

2. Protecting Casualty from Source

a. Thermal burns:

(1) Remove casualty from source of burn.

(2) If the casualty’s clothing is on fire, cover the casualty with a field jacket or any large non-synthetic material and roll him or her on the ground to put out flames.

CAUTION

Synthetic materials will melt and cause additional injury.

b. **Electrical Burns:** Remove the casualty from the electrical source by using nonconductive materials such as rope, clothing, or dry wood.

WARNING

Do not touch wire or casualty with bare hands. Turn off the electrical current first, if it is nearby, but don't waste unnecessary time.

c. **Chemical burns:**

(1) Flush liquid chemicals with as much water as possible.

(2) Brush off loose particles of dry chemicals. If large amounts of water are available, flush the area. Otherwise do not flush.

(3) Smother burning white phosphorus with water, wet cloth, or wet mud. Keep phosphorus covered.

WARNING

Blisters caused by a blister agent are actually burns. Do not try to decontaminate skin where blisters have already formed. If blisters have not formed, decontaminate the skin.

d. Laser burns: Move casualty away from laser source while avoiding eye contact with the beams, if possible wear appropriate eye protection.

3. Giving First Aid for Burns.

a. Expose the wound by gently lifting and cutting any clothing covering the burn area unless it is stuck to the burn or a chemical environment exists.

NOTE: Electrical burns often have an entry and exit point. Treat both areas.

CAUTIONS

- (1) Do not pull clothing over the burns.
- (2) Do not break blisters.
- (3) Take first aid action for the burn.
- (4) Do not clean the burn.
- (5) Do not uncover the burn in a chemically contaminated environment.
- (6) Remove jewelry before swelling sets in, if applicable.
- (7) Place jewelry in casualty's pockets.

b. Apply casualty's field dressing or other clean material on the burn. (See Task 081-831-1032, "Perform First Aid for Bleeding of an Extremity.")

c. Cover white phosphorus with a wet cloth or mud to exclude air.

- d. Do not cause further injury.
 - (1) Do not break blisters.
 - (2) Do not place dressing over face or genitals.
 - (3) Do not apply ointment or grease to the burns.
- e. Take first aid actions to prevent shock. (See Task 081-831-1005, “Perform First Aid to Prevent or Control Shock.”)
- f. Seek medical help.

REFERENCES

FM 21-11	S0821
S0833	STP 21-1-SMCT

PERFORM FIRST AID FOR SPLINTING A FRACTURE 081-831-1034

CONDITIONS

Given a casualty who has an arm or leg, which you think is broken. The casualty has no more serious wounds or conditions that have not been treated. Materials to make a splint and to pad and tie the splint are available.

STANDARDS

Splint the suspected broken arm or leg so that the arm or leg does not move and circulation is not impaired.

TRAINING AND EVALUATION

Evaluation Preparation

Setup: Divide all soldiers into buddy-teams. One soldier will simulate being a casualty with either a leg or arm fracture, and the other soldier will simulate rendering first-aid. Each buddy team must have the field dressings, improvised field dressings, padding materials (strips of cloth, socks, handkerchiefs, etc), and improvised splints (branches of trees, unloaded rifles, long sticks, etc).

Brief Soldier: You observe a casualty with a possible fracture of an extremity. You are in a chemical free environment, perform the necessary first-aid.

Evaluation Guide

Performance Measures

1. Definitions and Materials.

a. Fracture: A fracture is any break to a bone causing discomfort, disability, or even death if left unattended. There are two types of fractures:

(1) Closed: A closed fracture is a break in the bone without a break to the skin.

(2) Open: An open fracture is a break in the bone as well as the overlying skin.

CAUTION

Special attention should be given to an open fracture when bones are extending from the flesh. **DO NOT ATTEMPT TO PUSH THEM BACK UNDER THE SKIN.** Apply a field dressing to stop the bleeding and protect the area. See Task # 081-831-1032, “Perform First Aid for Bleeding of an Extremity.”

b. Splinting materials and splint:

(1) Splinting materials consist of splints, padding, and ties (cravats). All of these items can be improvised if necessary.

a. Padding can be improvised from such items as a jacket, blanket, poncho, shelter half, or leafy vegetation.

b. Splinting materials can be improvised from wooden boards, tree branches, poles, or an unloaded rifle.

c. A cravat can be improvised from a piece of cloth, a large bandage, a shirt, or a towel, to form a tie around a suspected fracture.

(2) A splint is any rigid material, i.e., wooden boards, branches, poles and casualty’s unloaded rifle, used for immobilizing a fractured extremity.

NOTE: Make sure that splints are long enough to immobilize the joints above and below the suspected fracture site.

c. Dislocations and sprains:

(1) A dislocation is a displacement of a bone end from the joint. The surrounding ligaments and other soft tissue always suffer some injury.

(2) Sprains are injuries to the soft tissues surrounding joints. The ligaments, muscle tendons, and blood vessels are stretched and occasionally torn or partially torn.

CAUTION

Splint a suspected dislocation or a sprain in the same manner as a closed fracture.

2. Locating the Site of a Suspected Fracture.

a. Task #081-831-1000, "Evaluate a Casualty," will be performed prior to administering first aid to splint a suspected fracture. Task #081-831-1032, "Perform First Aid for Bleeding of an Extremity," will be performed if an open fracture is involved. You, the soldier, evaluate the casualty by checking the entire body for other injuries and performing necessary lifesaving measures first. Only after you have performed lifesaving measures do you administer first aid to splint a suspected fracture.

b. Ask the casualty about the location of the suspected fracture (i.e., pain, tenderness, inability to move).

c. Look for unnatural positions of the extremities and for a protruding (sticking out) bone.

CAUTION

Unless there is immediate life-threatening danger (i.e., fire, explosions), **DO NOT MOVE THE CASUALTY WITH A SUSPECTED BACK OR NECK INJURY.** Movement may cause permanent paralysis or death. Do not remove any protective clothing or boots in a chemical environment. Apply the dressing over the clothing.

d. Reassure the casualty if he is conscious and able to understand. For example, tell him that you will be taking care of him.

e. Check circulation below the site of the injured area by completing these checks:

(1) Check light-skinned persons for pale white or bluish-gray color of skin.

(2) Check dark-skinned persons by depressing the toe/fingernail beds and observing how fast the color returns. A slower return of color to the injured side when compared to the uninjured side indicates a problem with circulation.

(3) Check to see if the injured arm or leg feels colder than the uninjured one. Use your hand to compare temperature. Poor circulation is indicated by the coldness of the body area below the injury.

(4) Questioning the casualty about the presence of numbness, tightness, or cold sensation.

f. Remove all jewelry from the affected limb and place it in the casualty's pocket. Tell the casualty that you are doing this to prevent further injury if swelling occurs later.

WARNING

A casualty with impaired circulation should be evacuated as soon as possible to prevent loss of the limb.

3. Splint or Immobilize a Suspected Fracture.

a. Splint:

WARNING

If it is an open fracture, the task “perform first aid for bleeding of an extremity” (081-831-1032) will be performed prior to splinting an open fracture.

(1) Splint the fracture in the position found.

CAUTION

Do not attempt to reposition or straighten the suspected fracture.

(2) Select splints that reach beyond the joints, above and below the fracture site.

(3) Position the splints and apply padding between splints and where they touch any bony part of the body (i.e., elbow, hips, knees, ankles). Also protect the crotch and armpit areas.

(4) Take four improvised (or actual) cravats and push cravats through and under the normal body curvature.

CAUTION

Insure minimal amount of movement of the injured area.

(5) Tie all four improvised (or actual) cravats on the splint, two above and two below the fracture, to secure the splint.

(6) Tie non-slip knots on the splint, on the side which is away from the body (injury).

(7) Recheck circulation after splinting.

(8) Check splint:

a. For looseness. Splints cannot be moved easily.

b. For tightness. Slip no more than two fingers between the improvised (or actual) cravats and the splints.

b. Immobilize:

(1) Arm - strapping the suspected fracture to the chest wall.

(2) Leg - strapping the suspected fracture to the uninjured leg.

NOTE: Particular attention should be given to a suspected elbow fracture. It must be secured to the body with a swathe to prevent movement of the extremity.

c. Apply swaths.

(1) Definition - a swath is any band or wrapping which is used to immobilize an injured arm or leg.

(2) Purpose - to prevent further movement of the injured arm or leg.

(3) Improvised swaths. Use any large piece of cloth or a belt or strips from a blanket or clothing.

(4) A suspected elbow fracture or dislocation. Use swaths to immobilize the splinted arm against the body wall so that it does not move easily and cause further injury. Explain that the swaths are not placed directly on top of the injury. In the graphic the swaths are positioned above and below the injury.

(5) Apply Swathes to an injured arm by wrapping the swathes over the injured arm, around the casualty's back, and under the arm on the uninjured side. Tie the ends on the uninjured side. Place swathes above and/or below the fracture, not over it.

(6) Apply swathes to an injured leg by wrapping the swathes around both legs and tying the swathes on the uninjured side.

(7) When splints are unavailable, swathes can be used to immobilize an injured extremity.

a. Tie an arm fracture to the chest wall.
Use improvised swathes, such as a belt or strips of cloth.

b. Tie a leg fracture to the uninjured leg.

REFERENCES

FM 21-11

PERFORM FIRST AID AND PRACTICE INDIVIDUAL PREVENTIVE MEDICINE COUNTERMEASURES 081-831-1053

CONDITIONS

You are a soldier deployed to a unit in the field. Necessary equipment and materials: water, food, uniforms, replacement clothing, standard military skin extended-duration arthropod repellent lotion, permethrin clothing repellent, malaria pills, soap, mosquito bednet, iodine tablets, canteen, covered container, plastic bags, earplugs, foot powder, talcum powder, razor, toothbrush, dental floss, and an entrenching tool.

STANDARDS

Apply preventive medicine measures to protect against: cold, heat, arthropod bites and arthropod-borne diseases, water-borne diseases, food –borne diseases,, hearing loss, skin infections, sexually transmitted diseases (STD), acquired immunodeficiency syndrome (AIDS), foot problems and practice oral hygiene, disposal of waste and Army tobacco use rules.

TRAINING AND EVALUATION

Training Information Outline

Because of the close living quarters frequently found in an Army environment, personal hygiene is extremely important. Disease or illness can spread and rapidly affect an entire group. Historically, in every conflict of U.S. involvement, only 20 percent of all hospital admissions have been from combat injuries. The other 80 percent have been from diseases and nonbattle injuries (DNBI).

1. Background

a. Egyptian forces suffered 20,000 heat-related deaths, while Israeli forces had only 128 heat-related injuries. Israeli commanders used heat as a weapon, and the result is history. What else did the Israelis do right? The Israelis have a mandatory water consumption policy, and every leader at every level monitors water consumption.

b. The British, during the Falklands War had 109 cold injuries out of 777 casualties.

c. Insects contributed to Napoleon's problems with the Russian campaign. It is estimated that more than 100,000 of Napoleon's LeGrand Armee were lost due to louse-borne typhus. The threat of louse-borne typhus is one of the reasons that Enemy Prisoners of War (EPWs) in Southwest Asia were considered a big problem.

d. The U.S. commander of the 1980 Operation Bright Star in Egypt rewarded his troops for a job well done with a night on the town prior to redeployment. Thirty percent were infected with shigellosis and were vomiting and had severe diarrhea on the flight back to the United States.

2. Preventive medicine measures (PMMs) are simple, common sense actions that any soldier can perform and must know, for protection against cold weather conditions, heat injury, insect-borne disease, intestinal disorders known as diarrhea and dysentery, and hearing loss. It is each individual's responsibility to maintain good health and use PMMs to reduce time lost due to disease and nonbattle injuries.

3. Apply preventive medicine measures to protect against: cold, heat, arthropod bites and arthropod-borne diseases, water-borne diseases, food-borne diseases, hearing loss, skin infections, sexually transmitted diseases (STD), acquired immunodeficiency syndrome (AIDS), foot problems and practice oral hygiene, disposal of waste and Army tobacco use rules.

4. Reasons for Vulnerability

a. Harshness of the environment--Harsh environments are a part of military operations. Soldiers

must be prepared to live and fight in deserts, jungles, and the Arctic.

b. Natural defenses are reduced by exposure and fatigue--These defense mechanisms operate efficiently to protect against disease and climatic injury and are dependent upon our overall well-being. When you are placed in high stress situations such as climatic changes, sleep deprivation, and irregular meals, you become more susceptible to illness and combat stress. We have increased vulnerability in the Army, inevitably, because you must stand in countless lines, load onto noise-hazardous aircraft which dulls the senses, and be expected to be ready to fight or to otherwise perform the mission when you arrive.

c. Breakdowns in Basic Sanitation--While in garrison, clean water and proper waste disposal are rarely subjects of interest or concern to most soldiers. While in the field and especially in mission-oriented protection posture (MOPP) gear, things change. Even the most common tasks, such as changing socks, using the latrine, or washing hands become challenges and daily concerns. Breakdowns in basic sanitation can easily occur when basic personal hygiene practices are ignored or forgotten.

5. Operating in Cold Weather

a. Wear layers of loose clothing. Avoid any tight-fitting clothing including underwear. Dress as lightly as possible consistent with the weather to prevent sweating and subsequent chilling. Minimize sweating; when

clothing becomes wet or dirty, it loses its ability to provide warmth.

(1) Remove layers of clothing before doing strenuous work or when working in heated areas. This helps to prevent overheating that causes sweating. Wet or dirty clothing adds to the cold injury process.

(2) Replace layers of clothing when your strenuous work is completed.

(3) Launder clothing regularly.

NOTE: Low temperatures and low relative humidity--dry cold--promote cold injuries. In this environment body parts such as arm and leg muscles, fingers, toes, and facial muscles should be exercised to keep warm and to detect numbness.

b. Exercise to increase blood circulation.

Exercising body parts to increase blood circulation and to detect numbness include the following measures:

(1) Tighten and relax your arm and leg muscles.

(2) Tighten and relax your fingers and toes.

(3) Use your hands to massage and warm the face.

(4) Avoid smoking because smoking decreases blood flow to the skin.

(5) Physical and mental fatigue contribute to

apathy which leads to inactivity, personal neglect, carelessness, and reduced heat production. In turn, these increase the risk of cold injury.

NOTE: Most cold injuries to the feet result from soldiers not having a pair of dry socks available whenever the feet become moist or wet. Ideally a soldier should take at least five pairs of issue boot socks with him or her. Immersion syndrome (immersion foot and/or trench foot) may result during cold, wet conditions.

c. Change socks. Protecting the feet in a cold environment includes putting on dry socks during rest breaks to reduce the risk of frostbite and trench foot. Socks should be kept clean and dry. Damp socks can be dried by placing them inside your shirt.

NOTE: Severe frostbite and trench foot can result in the loss of hands or feet. Immersion foot and trench foot may result from exposure of the feet to wet conditions at temperatures from approximately 50° to 32° F. Inactive feet in damp or wet socks and boots or tightly laced boots which impair circulation are even more susceptible to injury.

NOTE: Dehydration occurs when the body loses excessive amounts of fluid, salt, and minerals. The danger of dehydration in cold weather operations is a serious problem. In cold weather, it is extremely difficult to realize that this condition exists.

d. Prevent dehydration. Prevent dehydration in cold weather by practicing the following:

(1) Continue to drink fluids such as potable water, juices, and warm, nonalcoholic beverages. Although inconvenient, each soldier should be sure to drink sufficient fluids to prevent dehydration. The amount of additional liquids consumed depends upon the individual and the type of work being done.

NOTE: Drinking a sufficient amount of fluids in cold weather is as important as it is in hot weather. In cold weather, you may not realize that your body is losing fluids and salt. Sweat evaporates rapidly or is absorbed so completely by the layers of clothing that it is seldom visible on the skin.

(2) Rest when possible. Rest is an important preventive measure. Individuals must realize that work done while bundled in several layers of clothing is extremely exhausting.

(3) Pair with a buddy.

(a) Remind each other to do warming exercises often.

(b) Watch for signs of cold injury such as frostbite, trench foot, and hypothermia.

(c) Drink sufficient amounts of water.

6. Operating in Hot Weather

a. Drink Water

(1) Your body needs a minimum amount of water for cooling, waste elimination, and metabolism. Drink water frequently. Any attempt to train the body to use less water can be harmful and may lead to heat injuries.

CAUTION

Hourly fluid intake should not exceed 1½ quarts. Daily fluid intake should not exceed 12 quarts.

(2) Depending on the type of work and the temperature drink ½ to 1 canteen of water every hour. (If your urine is dark yellow, you are not drinking enough water.)

(3) Drink small quantities of water frequently. It is better not to rely on thirst to remind you when to drink water. Individuals in a hot climate seldom feel thirsty enough to make up all water lost.

(4) Drink extra water before an attack or mission. Excess water in your system will help keep you physically strong and mentally sharp until the tactical situation allows time to drink again. You should not drink more than 1½ quarts hourly or 12 quarts daily.

(5) Maintain excess water in your system for strength and alertness. You should not drink more than 1½ quarts hourly or 12 quarts daily

(6) Protect yourself from dehydration and heat injuries associated with wearing full chemical protective gear. Drink more water. Work and rest as your leader directs.

(7) Remember that heat injuries can be prevented by drinking plenty of water. In hot climates, the body depends upon sweating to keep it cool; therefore, water intake must be maintained to allow sweating to continue. You should not drink more than 1 ½ quarts hourly up to a maximum of 12 quarts daily.

NOTE: Rest breaks give the body a chance to cool off; that is why it is important to rest whenever the tactical situation permits.

b. Rest

(1) Take rest breaks in accordance as the tactical situation permits.

(2) Use rest breaks to drink water and to cool off. Work and rest in the shade if at all possible.

NOTE: Heavy sweating will cause a salt loss in the body. Eating meals replaces salt.

c. Eat meals.

(1) Eat regular meals daily to replace salt lost through heavy sweating. Military rations contain all the salt needed. Salt tablets should not be used as a

preventive measure. Take a salt solution only when directed by medical personnel.

(2) Excess intake of salt should be avoided.

d. Protect yourself from exposure by--

(1) Wearing your uniform properly.

(2) Providing shade whenever possible.

(3) Using barrier creams and lotions.

7. Preventive Measures Against arthropod bites and arthropod-borne diseases.

a. Miscellaneous

(1) An arthropod is a segmented invertebrate of the phylum arthropod which includes insects, arachnids, crustaceans, centipedes and millipedes.

(2) The Department of Defense Arthropod Repellent System -- Deet on the skin + permethrin on the uniform + wear of the uniform = total protection.

(3) Extended-duration arthropod repellent skin lotion is a preparation that can be used on the skin.

b. Bug Repellent

(1) Bug Repellent should be applied to exposed areas of skin including—

- (a) Face.
- (b) Ears.
- (c) Neck.
- (d) Arms.
- (e) Hands.

(2) The repellent is NOT applied to--

- (a) Eyes.
- (b) Lips.
- (c) Sensitive skin.

(3) The arthropod repellent skin lotion is also applied two inches under the edges of the battle dress uniform (BDU). This includes the wrists, ankles, and waistline.

(a) Apply to the ankles to prevent insects from creeping between the uniform and boots.

(b) Blouse the uniform inside the boots to further reduce insects getting inside the clothing.

(c) Keep the repellent skin lotion away from flame or excessive heat and always wipe hands after application.

(d) Repeat application of repellent skin lotion every six hours during strenuous activity and soon after any activity, such as stream crossing, that washes away the repellent.

NOTE: Wearing after-shave lotion or cologne in the field attracts biting or stinging insects.

(e) Read the label on insect repellent for directions and precautions before use.

(4) Applying permethrin clothing repellent. Use either the IDA kit (most effective) or aerosol treatments.

(a) Follow the directions on the product label!

(b) Use only on fabric.

(c) Treat outside of the BDU, insect headnet, and mosquito bednet.

(d) Treat all areas of the uniform.

(e) Dry clothing (BDUs) thoroughly prior to wearing.

(f) Follow these precautions--

- i. Do not apply to skin.
- ii. Do not treat BDUs while being worn.
- iii. Do not treat underwear or inside the cap.
- iv. Avoid breathing vapors.
- v. Wear your uniform properly.
- vi. Tuck pants legs into the boots, roll the sleeves down, and close the collar.
- vii. Wear the uniform loosely.
- viii. Check clothing frequently.
- ix. Use the buddy system to check areas of your body not easily seen during self-examination.

c. Take malaria pills to protect against malaria parasites. These pills should be taken when directed by the commander.

d. Clean and inspect yourself.

(1) Cleaning and inspecting your body to protect against arthropod bites includes the following:

(a) Wash yourself daily if the tactical situation permits. Pay particular attention to the groin and the armpits.

(b) Use the buddy system to check each other for ticks and other arthropod bites. (If ticks are found attached, seek medical attention.)

(c) Use insecticide powder, cream, or shampoo when prescribed by medical personnel.

(2) Ensure that students understand that proper wear of the uniform will also reduce the incidence of bites. The following points will be helpful in protecting your body:

(a) Wear headgear to protect the top of your head.

(b) Wear a loose-fitting uniform (not tightly tailored) and repair any tears or holes.

(c) When the arthropod threat is high, use the following measures for protection:

(d) Blouse the pants in the boots and completely lace the boots.

(e) Tuck the undershirt in at the waist.

(f) Wear sleeves down.

(g) Button the blouse or shirt at the neck and the wrists.

(3) Clean and inspect your clothing.

(a) Cleaning and inspecting your uniform will also provide protection against insect bites.

(b) Wash your uniform to remove arthropods and their eggs. If the situation permits, use the available military laundry service (quartermaster laundry).

(c) If laundry service is not available, scrub the uniform yourself with soap and water. The clothing seams may contain lice eggs which will hatch after a few days.

e. Use your bed net when sleeping.

(1) Protecting yourself against biting arthropods at night includes the use of your bed net and the use of insect spray inside the bed net.

(a) Suspend the bed net above the sleeping area.

(b) Tuck the edges of the bed net under the sleeping pad or bag.

(c) Treat the bed net with permethrin clothing repellent.

(d) Spray the interior space with d-phenothrin aerosol spray insecticide.

(2) Bed nets must be kept in good repair (mend any holes) in order for the preceding measures to be effective.

(3) Observe the following precautions when preparing their bed net:

(a) Avoid breathing vapors.

(b) Do not use permethrin clothing repellent or d-phenothrin aerosol spray insecticide on skin.

8. Purify Your Drinking Water

a. Fill your canteen with the cleanest water available.

b. Add iodine tablets.

(1) Add two tablets to a one-quart canteen of water.

(2) Double the amount of tablets if a two-quart canteen is used.

c. Replace the cap.

d. Wait five minutes for the tablets to dissolve.

- e. Shake the canteen to mix the contents.
- f. Tip the canteen to disinfect the cap threads.
- g. Loosen the cap.
- h. Tip the canteen over to allow leakage around the canteen threads.
- i. Turn the canteen right side up.
- j. Tighten the cap.
- k. Wait 30 additional minutes before drinking.

NOTE: There are alternate methods for purifying water, such as chlorine ampoules, tincture of iodine, or common household bleach. If none of the purifying agents are available, boil water for five to ten minutes.

9. Obtain food and drink from an approved source.

NOTE: Intestinal diseases are usually spread through contact with infectious organisms which can occur in improperly prepared or disinfected food and water supplies as well as in human waste.

- a. Obtain food, drink, and ice only from medically approved sources.
- b. Do not buy food, drinks, or ice from civilian vendors unless they have been approved by medical personnel.

(1) When eating in local establishments, eat only hot, cooked food.

(2) When eating food obtained from approved vendors, eat only foods that can be cooked or raw foods that can be washed and peeled.

(3) Inspect all cans and food packets prior to use. Discard cans with leaks or bulges. Discard food packets with visible holes or obvious signs of deterioration.

(4) Do not eat foods or drink beverages that have been prepared in galvanized containers. Such food and drink could cause zinc poisoning.

(5) Obtain food from the dining facility when possible. The dining facility is the best source for safe food.

c. Wash your hands for at least 30 seconds.

(1) Wash hands for at least 30 seconds to prevent disease.

(2) Wash after using the latrine.

(3) Wash before touching eating utensils or food.

(4) Wash after eating.

NOTE: Our hands come into contact with many sources of bacteria such as the latrine door, friend's hands, our nose, our weapons, and many others.

10. Food Waste Disposal. Waste disposal is an important element in the protection of soldiers' health in the field. Intestinal diseases are usually spread through contact with infectious organisms that can be spread by flies. Discuss the following points pertaining to food waste disposal:

- a. Use covered containers if available to keep out pests and to prevent breeding of flies.
- b. Use plastic bags in the event you have dumpster-type receptacles and regular waste pick-up.
- c. Bury your food waste immediately if other options are not available.
- d. Burying your waste immediately helps to prevent the spread of germs by flies and other insects. Burying waste also helps keep unwanted animals out of your bivouac area.

11. Prevent Hearing Loss

- a. To protect against hearing loss use individual measures against noise hazards.
 - (1) Use protective devices (earplugs, ear canal caps, or earmuffs) to reduce the risk of noise-related hearing loss. Earmuffs should be worn over earplugs in high steady-state noise level areas.

(2) Use vehicle headgear, such as helicopter crew helmets and armored vehicle crew helmets, for their excellent hearing protection qualities.

b. Keep hearing protection devices clean to avoid ear infections.

c. Avoid noise, and limit the time in noise hazardous areas to only the time necessary to perform the mission.

12. Prevent Skin Infections.

a. Preventing skin infections involves three simple steps.

(1) Bathe frequently. Take a full bath or shower at least once every week. If showers or baths are not available, you should use a washcloth daily to wash your genital area, your armpits, your feet, and any other areas where you sweat or which become wet. These areas include the thighs and, for females, under the breasts. Use of perfumed soaps or feminine deodorants in the field could cause irritation.

(2) Keep your skin dry. Using foot powder on your feet is recommended. This is especially important if you have had fungal infections in the past. Talcum powder is recommended for areas where wetness is a problem. If talcum powder is not available, use cornstarch as a substitute.

(3) Change to clean clothing after a full bath or shower. Loose-fitting uniforms allow for better

ventilation and blood circulation. Wear proper clothing for the environment. Nylon and silk-type undergarments are not suitable, especially in hot weather. Cotton undergarments are more absorbent, and they allow the skin to dry.

b. Males should shave facial hair often enough to be clean shaven to allow a tight fit of the protective mask.

NOTE: Nylon or silk-type undergarments are not suitable for wear in a field environment. Stress the importance of wearing cotton undergarments.

13. Proper foot care.

a. Foot Care (Before movement). Before movement, you must take the following steps in caring for your feet:

(1) Wear the proper type of footgear that is correctly fitted and broken in.

(2) Wear clean socks that are free of holes or knotty darns.

(3) Use foot powder and clean socks.

(4) Treat and protect blisters, pressure spots, and infections before movement.

b. Foot Care (During movement). During movement, you can care for your feet by following these simple suggestions:

- (1) Keep your feet as dry as possible.
- (2) Change socks (if possible) when they become damp or wet.
- (3) Dry socks by putting them under your shirt around your waist.
- (4) Relieve tender pressure spots on the feet by adjusting your gear.
- (5) Dust your feet with foot powder once or twice daily.
- (6) Inspect your feet at rest periods.
- (7) Wash your feet during the noon break if possible.
- (8) Raise your feet while resting to help reduce congestion and swelling.
- (9) Take care of blisters whenever time permits.
- (10) Wash the blister and the surrounding area with soap and water.

c. Seek medical treatment for painful blisters or signs of infection such as redness, throbbing, and drainage.

14. Oral Hygiene.

- a. Good oral hygiene consists of three simple steps.

They are:

(1) Brush your teeth after every meal if possible. Toothpaste helps but it is not a necessity.

(2) Use dental floss at least once a day.

(3) Rinse your mouth with potable water after brushing and flossing. This care may prevent gum disease, infection, and tooth decay.

b. Going to the dentist at least once a year for an examination and treatment, if needed, can prevent serious problems.

15. Protect Against STDs.

a. Ensure that students understand that STD (including HIV) are infections that are transmitted through sexual contact with persons who are already infected. Avoiding sexual contact with persons who may have one of these infections is the surest way to avoid becoming infected. Because it is difficult to know who is infected with an STD or the HIV virus and who is not, the decision to have sex with someone should follow an estimate of the chances that the sexual partner may be infected. Persons who are more likely to be infected include, those who have more than one sex partner, unprotected sex, sex with casual partners, prostitutes or their clients, sex with partners who are HIV infected or who share needles with others.

NOTE: There is no cure for AIDS and there is no vaccination to prevent HIV infection. Soldiers must take

necessary precautions to protect themselves from being infected.

b. Follow the procedures listed below for protecting against STD:

(1) Males should use a condom every time during vaginal, anal or oral sex when an STD infection may be transmitted. This practice will protect both male and female partners.

(2) Avoid high risk sexual behaviors

(a) Having sex with more than one sexual partner

(b) Changing sex partners often

(c) Having sex with casual partners, prostitutes or their clients

(d) Sexual practices such as anal sex

(3) Control alcohol intake (it effects your ability to use safe sex practices).

16. Protect Against AIDS.

a. In addition to sexual contact the HIV virus can be spread through the practice among drug abusers of sharing needles when injecting drugs. The virus is passed from an infected person to another through the

blood which contaminates the shared needles or syringes.

b. Do not use injected non-prescribed drugs or permit yourself to be injected or cut with a non-sterile sharp object; avoid tattoos and body piercing with non-sterile needles.

c. Avoid having sex with persons who might be infected with HIV. At highest risk are those who have more than one sex partner, unprotected sex, sex with casual partners, prostitutes or their clients, sex partners who are HIV infected or who share needles with others.

17. Waste Disposal.

a. Waste disposal is an important element in the protection of soldiers' health in the field. Intestinal diseases are usually spread through contact with infectious organisms which can be spread in human waste. The method used for disposal of waste depends upon the military situation and the unit and its location. Waste disposal does impact upon the health of a unit's personnel and must be done correctly.

b. Recommended methods of disposing of human waste are as follows:

(1) Use the unit latrine when available. (Deep Pit for Extended bivouac.)

(2) Use a cat-hole latrine on marches. On a march cover the cat-hole with dirt immediately after use.

(3) Use a straddle trench for 1-3 day bivouac.

(4) Other Waste: The handling of other waste such as garbage and rubbish depends upon the length of stay in the field. For periods of less than one week in the field, bury garbage and rubbish. The primary reason for burying waste is to prevent the breeding of flies. Flies increase the incidence of diarrhea and dysentery.

18. Department of the Army Smoking Policies.

a. The DOD has a smoke-free workplace policy. The Army has the same policy. Programs have been established to help soldiers and family members become tobacco-free.

b. Effects of Tobacco Use

(1) Long Term Health Costs of Tobacco Use

(2) Leading Cause of Death United States:
Heart and blood vessel disease

(3) Leading Preventable Cause of Death:
Tobacco Use

NOTE: Tobacco use is responsible for more deaths than all other causes: 450,000 plus deaths per year. That's equivalent to two fully loaded jumbo jetliners colliding in mid-air, each day, with no survivors.

c. Diseases/Conditions Related to Tobacco Use

- (1) Heart Disease: Leading risk for heart attack..
- (2) Contributes to strokes and poor circulation.
- (3) Chronic lung diseases: emphysema, bronchitis.
- (4) Cancers: lung, throat, mouth, bladder, possibly cervix.
- (5) Osteoporosis (brittle bones).
- (6) Increases risk of surgery and prolongs healing process.
- (7) May decrease male fertility.
- (8) Affects health of nonsmokers.
 - (a) Second hand smoke linked to lung cancer, asthma attacks.
 - (b) Children exposed to cigarette smoke have more middle ear and lower respiratory infections.
 - (c) Smoking during pregnancy is associated with low birth weight and pre-term births.

(d) May increase risk of Sudden Infant Death Syndrome (SIDS).

d. Smokeless Tobacco

(1) Smokeless tobacco use in the military has increased, particularly among males aged 18 - 24.

(2) In the overall U.S. population, a slight decrease in use by that age group is reported.

NOTE: Many people believe smokeless tobacco is safer than smoking. It is well established that smokeless tobacco of all types (chew, snuff, bandits) leads to the development of heart disease, various cancers, gum recession, and bone loss around the teeth. Cancers of the mouth and throat are particularly deforming and deadly.

(3) Effect on soldiers performance and health.

(4) Increases number of sick call visits.

NOTE: Smoking makes it far more likely that you will be susceptible to upper respiratory infections (colds and flu), which may progress to pneumonia.

(5) Decreases readiness

(6) Decreases night vision.

(7) Decreases hand-eye coordination.

(8) Decreases stamina.

- (9) Increases cold weather injuries.
- (10) Increases overall number of injuries.
- (11) Leads to addiction.

NOTE: There are far more smoking-related deaths every year than deaths due to illicit drug use. Despite the fact that people know tobacco is bad for their health and longevity, and want to give it up, it is very difficult for most to do so. The physical and emotional dependence developed with tobacco use is very great. Withdrawal symptoms are unpleasant. Often tobacco users feel jittery and irritable after a certain period of time without nicotine. These are symptoms of withdrawal! We need soldiers who are alert, can concentrate on the task at hand, and who are team players, not individuals who are easily aggravated by other people or stressful situations due to their bodies' reaction to not having tobacco.

e. AR 600-63 Army Health Promotion.

- (1) Smoking prohibited during Basic Combat Training
- (2) Prohibited smoking during AIT
- (3) Smoking prohibited in all DA-occupied work places.
- (4) Available resources for tobacco use cessation.

(a) Your doctor, nurse, physician's assistant (PA), or Primary Care Provider.

NOTE: Your health care provider may be able to prescribe medication to help with your cessation effort.

(b) Smoking cessation programs are usually sponsored by the health care facility or the local preventive medicine service.

(c) Self-help materials available from: Medical Treatment Facility and health care providers.

(d) Preventive Medicine

(e) Community agencies such as the American Cancer Society (800-486-2345) or the local public health department.

(5) Other Assistance

(a) Nicotine gum, nicotine patches

(b) Family and unit support is critical

f. Closing Statement: The bottom line is tobacco use detracts from readiness.

REFERENCES

FM 21-11

PERFORM FIRST AID FOR NERVE AGENT INJURY 081-831-1044

CONDITIONS

You and your unit have come under a chemical attack. You are wearing protective over-garments and or mask, or they are immediately available. There are casualties with nerve agent injuries. Given chemical protective gloves, over-garments, over-boots, protective mask and hood, mask carrier, and nerve agent antidote auto-injectors. The casualty has three nerve agent antidote auto-injectors and one convulsant antidote for nerve agents (CANA) auto-injector.

STANDARDS

Correctly administer the antidote to yourself and administer three sets of nerve agent antidote auto-injectors followed by the CANA to a buddy following the correct sequence.

TRAINING AND EVALUATION

Evaluation Preparation

Setup: You must use nerve agent antidote injection training aid to train and evaluate this task. Actual auto-injectors will not be used. For self-aid, have the soldier dress in MOPP level 2. Have the soldier wear a mask carrier containing a mask and the training nerve agent auto-injectors. For buddy-aid, have the soldier being tested and the casualty dress in MOPP level 2. Have the casualty lie on the ground wearing the mask carrier containing a mask and the training nerve agent auto-injectors.

Brief Soldier: For self-aid, tell the soldier to state, in any order the mild symptoms of nerve agent poisoning. The soldier must state seven of the eight symptoms to be scored GO. Then, tell the soldier that he or she has mild symptoms and to take appropriate action. For buddy-aid, tell the soldier to state, in any order, the severe symptoms of nerve agent poisoning. The soldier must state eight of the nine symptoms to be scored GO. Tell the soldier to treat the casualty for nerve agent poisoning.

Evaluation Guide

Performance Measures

NOTE: When performing first aid on a casualty seek medical aid as soon as possible. Do not stop the first aid, but if the situation allows, send another person to find medical aid.

1. Perform Self-Aid if Suffering from Nerve Agent Poisoning

a. Identify mild symptoms of nerve agent poisoning.

- (1) Unexplained runny nose.
- (2) Unexplained sudden headache.
- (3) Excessive flow of saliva (drooling).
- (4) Tightness of chest, causing breathing difficulties.
- (5) Difficulty seeing (blurred vision).

(6) Muscular twitching of exposed/ contaminated skin.

(7) Stomach cramps.

(8) Nausea.

NOTE: For the above signs and symptoms first aid is considered to be self-aid.

b. Identify severe signs and symptoms of nerve agent poisoning.

(1) Strange and confused behavior.

(2) Gurgling sounds made when breathing.

(3) Severely pinpointed pupils.

(4) Red eyes with tearing.

(5) Vomiting.

(6) Severe muscular twitching.

(7) Loss of bladder and/or bowel control.

(8) Convulsions.

(9) Unconsciousness or stoppage of breathing.

NOTE: If the casualty is exhibiting severe symptoms, assistance (buddy-aid) is required by the individual to complete first aid treatment.

c. React to the chemical hazard.

(1) Put on your protective mask.

NOTE: Additional protective clothing will not be put on at this time.

(2) Give the alarm.

NOTE: Do not put on additional protective clothing at this time. Give yourself the nerve agent antidote first. Then decontaminate exposed skin areas and put on remaining protective clothing.

d. Administer nerve agent antidote to self (Self-Aid), if necessary.

(1) Prepare to administer one atropine injection.

NOTE: If you have the M17 series protective mask, the auto injectors will normally be stored in the mask carrier. The M40 Series mask carrier does not have room for storage of auto injectors; unit SOP dictates storage location, usually the BDU pocket.

a. Remove one set of auto-injectors from the mask carrier.

- b. With one hand, hold the set of injectors by the plastic clip with the big injector on top.
- c. With the other hand, check the injection site to avoid buttons and objects in pockets.
- d. Grasp the small injector without covering or holding the needle (green) end, and pull it out of the clip with a smooth motion.
- e. Hold the injector between the thumb and first two fingers without covering or holding the needle (green) end.

NOTE: If the injection is accidentally given in the hand another small injector must be obtained and the injection given in the proper site.

- f. Place the needle end of the injector against the outer thigh muscle.

NOTE: The injection can be given in any part of the lateral thigh muscle from about a hand's width above the knee to a hand's width below the hip joint.

CAUTION:

When injecting antidote in the buttocks be very careful to inject only into the upper outer quarter of the buttocks to avoid hitting the major nerve which crosses the buttocks. Hitting the nerve may cause paralysis.

NOTE: Very thin soldiers should give the injection in the upper outer part of the buttocks.

(2) Administer the atropine injection.

a. Push the injector into the muscle with firm, even pressure until it functions.

b. Hold the injector in place for at least 10 seconds.

NOTE: A jabbing motion is not necessary to trigger the activating mechanism.

c. Remove the injector from your muscle and carefully place this used injector between two fingers of the hand holding the plastic clip.

(3) Prepare to administer one 2 PAM Cl injection.

a. Pull out the large injector, forming a fist around it as before.

b. Place the needle (black) end of the injector against the injection site.

(4) Administer the 2 PAM Cl injection.

a. Push the injector into the muscle with firm, even pressure until it functions.

b. Hold the injector in place for at least 10 seconds.

(5) Secure the used injectors.

- a. Drop the clip without dropping the injectors.
- b. Push the needle of each used injector (one at a time) through one of the pocket flaps of the protective overgarment.
- c. Bend each needle to form a hook without tearing protective gloves or clothing.
- e. Decontaminate your skin, if necessary.

NOTE: Information on this step is provided in task Decontaminate Yourself and Individual Equipment Using Chemical Decontamination Kits, task number 031-503-1013.

- f. Put on any remaining protective clothing.

NOTE: Information on this step is covered in task Protect Yourself From NBC Injury/Contamination With the Appropriate Mission Oriented Protective Posture (MOPP) Gear, task number 031-503-1015.

WARNING

If within 5 to 10 minutes after administering the first set of injections your heart begins beating rapidly and your mouth becomes very dry do not administer another set of injections.

- g. Seek buddy or medical aid.

NOTE: After you have given yourself the first set of injections you most likely will not need additional antidote if you can walk and know who and where you are. If needed the second and third sets of injections will most likely be given by a buddy or by medical personnel.

WARNING

Do not kneel at any time while providing aid to the casualty. Contact with the ground could force the chemical into or through the protective clothing.

NOTE: Reposition the casualty on his or her back if necessary to mask the individual.

2. Perform First-Aid for a Buddy Suffering From Nerve Agent Poisoning (Buddy-Aid).

a. Mask the casualty if necessary.

(1) Place the mask on the casualty.

(2) If the casualty can follow directions, have him or her clear the mask.

(3) Check for a complete mask seal by covering the inlet valves of the mask.

(4) Pull the protective hood over the head, neck, and shoulders of the casualty.

b. Position the casualty on the right side, similar to a swimmer position, with head slanted down so that the casualty will not roll back over.

c. Administer first aid to a nerve agent casualty (Buddy-Aid).

(1) Prepare to administer one atropine injection.

(2) Remove all three sets of auto-injectors and the single CANA auto-injector from the casualty's mask carrier or BDU pocket.

(3) With one hand, hold the set of injectors by the plastic clip with the big injector on top.

(4) With the other hand, check the injection site to avoid buttons and objects in pockets.

(5) Grasp the small injector and pull it out of the clip with a smooth motion.

(6) Hold the injector between the thumb and first two fingers without covering or holding the needle (green) end.

(7) Place the needle end of the injector against the casualty's outer (lateral) thigh muscle.

NOTE: The injection can be given in any part of the lateral thigh muscle from about a hand's width above the knee to a hand's width below the hip joint. Very thin

soldiers should be given the injections in the upper outer part of the buttocks.

(8) Administer the atropine injection.

a. Push the injector into the muscle with firm, even pressure until it functions.

b. Hold the injector in place for at least 10 seconds.

c. Carefully place the used injector between two fingers of the hand holding the clip.

(9) Prepare to administer one 2 PAM Cl injection.

a. Pull the large injector out of the clip and hold it between the thumb and first two fingers as you did with the small injector.

b. Place the needle (black) end of the injector against the injection site.

(10) Administer the 2 Pam Cl injection.

a. Push the injector into the muscle with firm, even pressure until it functions.

b. Hold the injector in place for at least 10 seconds.

c. Drop the clip without dropping injectors.

d. Lay the used injectors on the casualty's side.

NOTE: Repeat steps 10a through 10d until the casualty has received a total (including self-administered) of three sets of antidote injections.

(11) Prepare to administer the CANA injection.

a. Tear open the protective plastic packet and remove the injector.

b. Grasp the injector with the needle (black) end extending beyond the thumb and two fingers (index plus next finger).

c. With the other hand, pull the safety cap off the injector base to arm the injector.

d. Place the black end of the injector against the casualty's injection site.

CAUTION

DO NOT touch the black (needle). You could accidentally inject yourself.

(12) Administer the CANA injection.

a. Push the injector into the muscle with firm, even pressure until it functions.

b. Hold the injector in place for at least 10 seconds.

(13) Secure the used injectors.

a. Push the needle of each used injector (one at a time) through one of the pocket flaps of the casualty's protective over-garment.

b. Bend each needle to form a hook without tearing protective gloves or clothing.

d. Decontaminate the casualty's skin if necessary.

NOTE: This information is covered in task Decontaminate Yourself and Individual Equipment Using Chemical Decontamination Kits, task number 031-503-1013.

3. Seek Medical Aid.

4. Perform all steps in the correct sequence.

REFERENCES

FM 21-11 STP 21-1-SMCT
FM 8-285

PERFORM FIRST AID AND TRANSPORTING CASUALTIES 081-831-1046

CONDITIONS

You have come across a casualty who is in need of aid, but the casualty is in a hazardous location, or you have evaluated and given first aid to a casualty. You need to move the casualty to get further medical aid. You may have the help of another soldier. Materials to make a litter may be available.

STANDARDS

Transport the casualty, without dropping him or causing further injury; using an appropriate one- or two-man carry or properly improvised litter.

TRAINING AND EVALUATION

Evaluation Preparation

Setup: Have a soldier play the part of the casualty. Select a carry which is appropriate to the situation and transport the casualty without causing further injury.

Brief Soldier: After evaluating the casualty and administering first aid, you must decide upon the most effective means of transporting a casualty using a manual carry.

Evaluation Guide

Performance Measures

NOTE: When Performing First Aid On A Casualty, Seek Medical Aid As Soon As Possible. Do Not Stop The First Aid, But, If The Situation Allows, Send Another Person To Find Medical Aid.

1. Types of One-Man Carries - In a tactical situation, one-man carries are often used to transport casualties. Your choice of which type of carry to use depends upon the seriousness of the illness/injury, weight of the casualty, strength of the carrier, and the distance to be traveled.

a. Support Carry

(1) You will evaluate the casualty by checking the entire body for injuries and performing necessary lifesaving measures first. Only after you have performed these lifesaving measures can you transport the casualty. Example: Clear airway before attempting to move the casualty.

(2) Assist the casualty to a standing position.

(3) Grasp the casualty's wrist and draw his arm around your neck. Place your arm around his waist.

NOTE: The Support Carry is used for casualties who are able to walk or at least hop on one leg. The casualty uses your body as a crutch.

(4) Of major importance is bringing a casualty to a standing position, as it is used as a basis for several one-man carries (for example, the Support Carry, The Arms Carry).

b. Fireman's Carry

(1) Bring the casualty to a standing position:

a. Roll the casualty over onto his stomach.

NOTE: This step may not be needed, as not all casualties will be lying on their backs when encountered.

b. Straddle the casualty; place your hands under his chest and lock them together.

c. Raise the casualty to his knees as you move backwards.

d. Continue to move backwards, straightening the casualty's legs and locking his knees.

e. Walk forward until the casualty is standing; lean him slightly backwards to keep his knees from buckling.

(2) Move to a face-to-face position.

(3) Place one arm around the casualty's waist. Use your other arm to raise his arm straight up.

(4) Pass your head under his raised arm, releasing it as you pass under it until you are facing the casualty. Place your hands around his waist and your right foot in between his feet.

(5) Raise the casualty onto your shoulders.

(6) Stoop/bend down and pull the casualty across your shoulders. Place your other arm in between the casualty's knees.

(7) Grasp the casualty's right wrist with your right hand or left wrist with your left hand and place your other arm on your knee for support.

(8) Raise the casualty onto your shoulders. Rise slowly to a standing position.

NOTE: The Fireman's Carry is usually used with unconscious or severely injured casualties.

c. Arms Carry.

(1) Raise the casualty to a standing position. (See first part of Fireman's Carry if casualty is unconscious or severely injured.)

(2) Place one arm under the casualty's knees and your other arm around his back; lift the casualty.

NOTE: The Arms Carry may be used for a conscious or unconscious casualty who is not able to walk. Carry the casualty high to lessen fatigue. Tell the conscious casualty to put his arms around your neck.

d. Pack Strap Carry.

(1) Raise the casualty to a standing position. (See first part of Fireman's Carry if casualty is unconscious or severely injured.)

(2) Support the casualty with one arm around his waist; grasp his wrist closest to you with your other arm and place it over your head. Move in front of the casualty with your back to him.

(3) Place his arms over your shoulder. Follow the same procedure with the other arm while leaning his body against your back.

(4) Grasp his wrists. Bend forward and raise the casualty as high as possible, until his body weight is on your back. Pull the casualty forward until his armpits are on your shoulders.

e. Saddle Carry.

(1) Raise the casualty to a standing position.

(2) Move in front of the casualty with your back facing him.

(3) Tell the casualty to place his arms around your neck and hold his hands together.

(4) Stoop down, raise the casualty upon your back (piggy-back) and clasp your hands together beneath his thighs.

NOTE: The Saddleback Carry requires a conscious casualty, as he must be able to hold his hands together around the carrier's neck.

f. Pistol Belt Carry.

(1) Form a sling by joining together two pistol belts, or any improvised material which will not cut or bind the casualty. Place the sling under the casualty's thighs and the lower back with a loop extending from each side, and with the buckles centered behind the casualty. Lay the soldier on his back.

(2) Lie face up between the casualty's outstretched legs. Thrust your arms through the loops and grasp his or her hand and trouser leg on the injured side.

(3) Roll in the direction of the casualty's uninjured side onto your stomach, bringing him onto your back. Adjust the sling as needed.

(4) Rise with casualty to a kneeling position and then to a standing position, slightly bent forward at the waist.

(5) Carry the casualty with his full weight upon your shoulders

NOTE: The Pistol Belt Carry is the best one-man carry for long distances. Your hands are free to use in firing a rifle, climbing banks, or moving around obstacles; the belt will hold the patient in place.

g. Pistol Belt Drag.

(1) Adjust/extend two pistol belts or similar objects to their full length and join them together to make one loop.

(2) Roll the casualty on his back.

(3) Pass the loop over the casualty's head and place it across his chest and under his armpits; then cross the remaining part of the loop to form a figure 8.

CAUTION

Ensure the buckles cross in the center of the figure 8. Keep tension on the belt so they do not become unhooked.

(4) Lie on your side alongside and facing the casualty.

(5) Slip the loop over your nearest arm and shoulder and turn onto your stomach, away from the casualty.

(6) Drag the casualty as you crawl.

NOTE: The Pistol Belt Drag, in addition to the other drags, is generally used to carry a casualty short distances.

h. Neck Drag.

(1) Tie the casualty's hands together at the wrists with a field dressing (or any other improvised material) that will not cut or bind.

CAUTION

Do not tie so tightly as to cut off circulation.

(2) Straddle the casualty, kneeling in a face-to-face position.

(3) Loop the casualty's hands over/around your neck.

(4) Crawling and looking forward, drag the casualty with you.

NOTE: The Pistol Belt Drag and the Neck Drag are useful in combat as the carrier and the casualty may remain close to the ground.

CAUTION

Not to be used with persons with broken arm(s).

i. Cradle-drop drag.

(1) With the casualty lying face up, kneel at his or her side. Slide your hands, palms up, under the casualty's shoulders and get a firm hold under the armpits.

(2) Partially rise while supporting the casualty's head on one of your forearms.

NOTE: You may bring your elbows together and let the casualty's head rest on both of your forearms.

(3) With the casualty in a semi-sitting position, rise and drag the casualty back-wards.

(4) Back down the steps (or if appropriate), supporting the casualty's head and body and letting his or her hips and legs drop from step to step.

2. Types of two-man carries – Manual carries are accomplished by one or two bearers. Two-man carries, are less likely to aggravate injuries and are less tiring for the bearers/carriers over long distances. The appropriate two-man

carry, as with a one-man carry, depends upon the distance to be traveled, the strength of the carriers, the weight of the casualty, the seriousness of the injury, and the tactical situation.

a. When the distance is too far for a manual carry, the casualty has a severe injury, or a standard litter is not available, a litter must be improvised from materials at hand. Some of the materials often used to make a litter in the field are ponchos, fatigue shirts/jackets and two poles/tree limbs.

WARNING

Unless there is an immediate life threatening situation (i.e., fire, explosion), do not move the casualty with a suspected back or neck injury. Seek medical personnel for guidance on how to transport.

b. Task #081-831-1000, "Evaluate the Casualty," will be performed prior to transporting the casualty with a two-man carry, or improvising a litter.

c. You will evaluate the casualty by checking the entire body for injuries and performing necessary lifesaving measures first. Only after you have performed these lifesaving measures do you transport the casualty. **EXAMPLE:** clear airway before attempting to move the casualty.

d. Two-man Support Carry

(1) Raise the casualty to his feet.

NOTE: If the casualty is lying on his back, roll him over on his stomach.

(2) Raise the casualty to a standing position while supporting him with your arms around his waist.

(3) The carriers grasp the casualty's wrists and draw his arms around their necks.

(4) Assist the casualty to move by continuing to:

a. Support him from the waist.

b. Hold on to his wrists securely.

(5) If the casualty is taller than the carriers, lift the casualty and position for carrying.

e. Two-Man Arms Carry

(1) Casualty is lying down. Prepare to lift the casualty.

(2) Carriers kneel at one side of the casualty; one soldier at the chest and one at the thighs of the casualty.

(3) Carrier closest to casualty's head slips his arms under casualty's shoulders and waist.

(4) Carrier closest to casualty's feet slips his arms under casualty's hips and knees.

(5) Lift the casualty and position him for carrying.

(6) Rise to your knees at the same time that you lift the casualty.

(7) Keep him level to prevent further injury.

(8) Bring the casualty toward your chests.

(9) Carriers rise to their feet.

f. Four-Hand Seat Carry

(1) To make a four-hand seat for a conscious casualty:

a. Carriers face each other.

b. Each carrier grasps his own left wrist with his right hand.

c. With your left hand grasp your partner's right wrist.

(2) Lift the casualty.

(3) Stand in back of the casualty.

(4) Squat your bodies at the same time to about the knee level of the casualty.

(5) Have the casualty sit on the hand-seat and place his arms around carrier's shoulders to help support himself.

(6) Carriers rise to their feet at the same time.

g. Two-Man-Fore-and-Aft Carry

(1) Position yourself.

a. One carrier positions himself at casualty's head, facing the casualty.

b. The shorter carrier positions himself at casualty's feet with his back to the casualty.

(2) Prepare to lift the casualty.

a. Carrier at the head of the casualty kneels on one knee, slides his arms under the casualty's arms, raises casualty up slightly, and locks his hands in front of the casualty's chest.

b. Carrier at casualty's feet spreads casualty's legs, kneels on one knee between them and lifts the casualty's legs, grasping the legs above the knees.

(3) Carriers lift the casualty. At the signal of the carrier at the head of the casualty, the two carriers rise together, lifting the casualty.

h. Improvised Litter

(1) Using the casualty's poncho and two poles.

a. Open the poncho and lay the two poles (limbs) lengthwise across the center.

b. Reach in and pull the hood up (toward you) and lay it flat on the poncho.

c. Fold the poncho over the first pole.

d. Fold the free edges of the poncho over the second pole.

(2) Using the Casualty's Shirts/Jackets, and Two Poles.

a. Button and/or zip two or three fatigue shirts or jackets and pull the sleeves inside.

b. Pass the poles through the sleeves.

(3) Placing and Transporting a Casualty on an Improvised Litter.

a. Place the casualty on the litter, using the Two-Man Arms Carry, or roll the casualty onto the litter.

b. Lift the litter.

c. Raise the litter at the same time as the other carrier/bearer.

d. Keep the litter as level as possible.

REFERENCES

FM 21-11

STP 21-1-SMCT

Appendix A: Quotations

- “In war, there is no substitute for victory.”
 - General Douglas MacArthur
- “I have never taken any command into battle with the slightest desire to come out of it alive unless I won.”
 - General P.H. Sheridan
- “War is an ugly thing but not the ugliest of things. The decayed and degraded state of mind that thinks nothing is worth fighting for is far worse.”
 - John Stuart Mill
- “Only the dead have seen the end of war.”
 - Plato
- “Battle is the ultimate to which the whole life’s labor of a [soldier] should be directed. He may live to the age of retirement without seeing a battle; still, he must always be getting ready for it exactly as if he knew the hour of the day it is to break upon him. And then, whether it come early or late, he must be willing to fight – he must fight.”
 - BG Charles F. Smith (1861)
- “God grants liberty only to those who love it and are *always ready* to defend it.”
 - Daniel Webster

Appendix A: Quotations (Continued)

- “Let every nation know, whether it wishes us well or ill, that we shall pay any price, bear any burden, meet any hardship, support any friend, oppose any foe, to assure the survival and success of liberty.”
 - President John F. Kennedy
- “I regret that I have but one life to lose for my country.”
 - Nathan Hale
- “To be prepared for war is one of the most effectual means of preserving the peace.”
 - President George Washington
- “Eternal vigilance is the price of freedom.”
 - Thomas Jefferson
- “Winning is not a sometime thing. You don’t win once in a while. You don’t do things right once in a while. You do them right all the time.”
 - Vince Lombardi
- “It is not enough to fight. It is the spirit which we bring to the fight that decides the issue. It is morale that wins the victory.”
 - General George C. Marshall

Appendix A: Quotations (Continued)

- “When duty whispers – ‘low, thou must’ – you must reply: ‘I can!’
- Ralph Waldo Emerson
- “When your shot is exhausted, knock down the enemy with the stock of your rifle. If the rifle stock be broken, bite with your teeth.”
- Russian Military Reader
- “No sweat, sir. You can count on me. We’ll stop them.”
- Last words of SPC James K. Stoddard as he lay bleeding (and he knew it).
26 February 1968 – Hill 614
- “You cannot be disciplined in great things and undisciplined in small things. There is only one sort of discipline – perfect discipline.”
- General George S. Patton, Jr.
- “You gain strength, courage, and confidence by every experience in which you really stop to look fear in the face. You must do the thing you think you cannot do.”
- Eleanor Roosevelt
- “Encourage us in our endeavor to live above the common level of life. Help us to choose the harder right instead of the easier wrong.”
- West Point Cadet Prayer

Appendix A: Quotations (Continued)

- “Invincibility depends on one’s self; the enemy’s vulnerability on him.”
 - Sun Tzu
- “Perpetual optimism is a force multiplier.”
 - General Colin Powell

Appendix B: Historic Documents

Extract from The Declaration of Independence

When in the Course of human events, it becomes necessary for one people to dissolve the political bands which have connected them with another, and to assume, among the Powers of the earth, the separate and equal station to which the Laws of Nature and of Nature's God entitle them, a decent respect to the opinions of mankind requires that they should declare the causes which impel them to the separation. We hold these truths to be self-evident, that all men are created equal, that they are endowed by their Creator with certain unalienable Rights, that among these are Life, Liberty, and the pursuit of Happiness. That to secure these rights, Governments are instituted among Men, deriving their just powers from the consent of the governed, That whenever any Form of Government becomes destructive of these ends, it is the Right of the People to alter or to abolish it, and to institute new Government...Prudence, indeed, will dictate that Governments long established should not be changed for light and transient causes...But when a long train of abuses and usurpations, pursuing invariably the same Object evinces a design to reduce them under absolute Despotism, it is their right, it is their duty, to throw off such Government, and to provide new Guards for their future security. --Such has been the patient sufferance of these Colonies; and such is now the necessity which constrains them to alter their former Systems of Government. The history of the present King of Great Britain is a history of repeated injuries and usurpations, all having in direct object the establishment of an absolute

Appendix B: Historic Documents (Continued)

Tyranny over these States. To prove this, let Facts be submitted to a candid world..... He has obstructed the Administration of Justice, by refusing his Assent to Laws for establishing Judiciary Powers. He has made judges dependent on his Will alone, for the tenure of their offices, and the amount and payment of their salaries.....He has kept among us, in times of peace, Standing Armies without the Consent of our legislatures. He has affected to render the Military independent of and superior to the Civil Power.....For quartering large bodies of armed troops among us: For protecting them, by a mock Trial, from Punishment for any Murders which they should commit on the Inhabitants of these States: For cutting off our Trade with all parts of the world: For imposing taxes on us without our Consent: For depriving us, in many cases, of the benefits of Trial by Jury..... He has plundered our seas, ravaged our Coasts, burnt our towns, and destroyed the lives of our people.....We, therefore, the Representatives of the United States of America, in General Congress, Assembled, appealing to the Supreme Judge of the world for the rectitude of our intentions, do, in the Name, and by the Authority of the good People of these Colonies, solemnly publish and declare, That these United Colonies are, and of Right ought to be Free and Independent States; that they are Absolved from all Allegiance to the British Crown, and that all political connection between them and the State of Great Britain, is and ought to be totally dissolved; and that as Free and Independent States, they have full Power to levy War, conclude Peace, contract Alliances, establish Commerce,

Appendix B: Historic Documents (Continued)

and to do all other Acts and Things which Independent States may of right do. And for the support of this Declaration, with a firm reliance on the Protection of Divine Providence, we mutually pledge to each other our Lives, our Fortunes and our sacred Honor.

Preamble to the Constitution of the United States

We the People of the United States of America, in Order to form a more perfect Union, establish Justice, insure domestic Tranquility, provide for the common defense, promote the general Welfare, and secure the Blessings of Liberty to ourselves and our Posterity, do ordain and establish this Constitution for the United States of America.

Appendix C: National Anthem (Star Spangled Banner) and Pledge of Allegiance

Star Spangled Banner

O say can you see by the dawn's early light
What so proudly we hail'd at the twilight's last gleaming
Whose broad stripes and bright stars through the perilous fight
O'er the ramparts we watch'd were so gallantly streaming?

And the rocket's red glare, the bomb bursting in air,
Gave proof through the night that our flag was still there,
O say does that star-spangled banner yet wave
O'er the land of the free and the home of the brave?

On the shore dimly seen through the mists of the deep,
Where the foe's haughty host in dread silence reposes,
What is that which the breeze, o'er the towering steep,
As it fitfully blows, half conceals, half discloses?

Now it catches the gleam of the morning's first beam
In full glory reflected now shines in the stream
'Tis the star-spangled banner—O long may it wave
O'er the land of the free and the home of the brave!

O thus be it ever when free men shall stand
Between their loved home and the war's desolation!
Blest with vict'ry and peace, may the heav'n rescued land

Praise the power that hath made and preserved us a nation!
Then conquer we must, when our cause it is just,
And this be our motto—"*In God is our Trust,*"
And the star-spangled banner in triumph shall wave
O'er the land of the free and the home of the brave.

Pledge of Allegiance

I pledge allegiance, to the flag, of the United States of America;

And to the Republic, for which it stands;

One nation, under God, indivisible;

With Liberty and Justice for all.

Appendix D: Army Song

The Army Goes Rolling Along

- Verse:** March along, sing our song
With the Army of the free.
Count the brave, count the true
Who have fought to victory.
We're the Army and proud of our name!
We're the Army and proudly proclaim.
- First Chorus:** First to fight for the right
And to build the nation's might.
And THE ARMY GOES ROLLING
ALONG.
Proud of all we have done,
Fighting till the battle's won.
And THE ARMY GOES ROLLING
ALONG.
- Refrain:** Then it's hi! hi! hey!
The Army's on its way,
Count off the cadence loud and strong:
For where'er we go, you will always know
That THE ARMY GOES ROLLING ALONG.
- Second Chorus:** Valley Forge, Custer's ranks,
San Juan Hill and Patton's tanks,
And the Army went rolling along.
Minutemen from the start,
Always fighting from the heart,
And THE ARMY KEEPS ROLLING
ALONG..

Appendix D: Army Song (Continued)

Refrain: Then it's hi! hi! hey!
The Army's on its way,
Count off the cadence loud and strong:
For where'er we go, you will always know
That THE ARMY GOES ROLLING ALONG.

Third Chorus: Men in rags, men who froze,
Still that Army met its foes,
And the Army went rolling along.
Faith in God, then we're right
And we'll fight with all our might
As THE ARMY KEEPS ROLLING
ALONG.

Refrain: Then it's hi! hi! hey!
The Army's on its way,
Count off the cadence loud and strong:
(two! three!)
For where'er we go, you will always know
That THE ARMY GOES ROLLING ALONG!
(Keep it rolling!)
And THE ARMY GOES ROLLING
ALONG!

Appendix E: Soldier's Code

THE SOLDIER'S CODE

- I. I am an American soldier – a protector of the greatest nation on earth – sworn to uphold the Constitution of the United States.
- II. I will treat others with dignity and respect and expect others to do the same.
- III. I will honor my Country, the Army, my unit and my fellow soldiers by living the Army Values.
- IV. No matter what situation I am in, I will never do anything for pleasure, profit, or personal safety which will disgrace my uniform, my unit, or my Country.
- V. Lastly, I am proud of my Country and its flag. I want to look back and say that I am proud to have served my Country as a soldier.

Appendix F: Soldier's Responsibilities

Soldiers in the United States Army take on two critical responsibilities that are uncommon to the average citizen. Members of the Armed forces have sworn to defend the Constitution of the United States and to obey the orders of the President and the Officers appointed over them.

1. Defend the Constitution: The Constitution (See Appendix B) is the document which established our modern-day government and outlines all of our rights as American citizens. Contained within it are the very words which authorize Congress to establish an Army. Written by James Madison and ratified by Congress in 1789, the Constitution has been a living document ever since and the centerpiece of the longest-standing democratic republic in history. As soldiers, we have sworn to defend the Constitution against all enemies, foreign and domestic. In doing so, we defend life, liberty, and the pursuit of happiness for hundreds of millions of Americans. We are *“prepared to give our lives in its defense.”*

2. Obey the Orders of the President of the United States and Officers Appointed Over You: The President's greatest responsibility – as Commander-in-Chief – is to preserve America's freedom. This may require him to employ American military forces and risk the lives of American soldiers. He is the pinnacle of the Chain of Command, and it is incumbent upon every soldier to obey his orders. This obedience goes hand-in-hand with defending the Constitution.

Appendix F: Soldier's Responsibilities (Continued)

By virtue of Congressional mandate, Commissioned officers receive their authority directly from the President. Therefore, when we receive orders from the officers appointed over us, we are indirectly receiving orders from the President of the United States.

In addition to these two primary responsibilities, soldiers should also carry out their duties as dedicated and responsible citizens. Every citizen soldier is duty-bound to vote, obey civil laws, and partake in the community on a positive level.

Appendix G: General Orders

1st General Order

I will guard everything within the limits of my post and quit my post only when properly relieved.

2nd General Order

I will obey my special orders and perform all of my duties in a military manner.

3rd General Order

I will report violations of my special orders, emergencies, and anything not covered in my instructions, to the commander of the relief.

Appendix H: Code of Conduct

I

I am an American,
fighting in the forces which guard my country and our way
of life.

I am prepared to give my life in their defense.

II

I will never surrender of my own free will.
If in command I will never surrender the members of my
command while they still have the means to resist.

III

If I am captured, I will continue to resist by all means
available.
I will make every effort to escape and aid others to escape.
I will accept neither parole nor special favors from the
enemy.

IV

If I become a prisoner of war, I will keep faith with my
fellow prisoners.
I will give no information or take part in any action which
might be harmful to my comrades.
If I am senior, I will take command. If not, I will obey the
lawful orders of those appointed over me and will back
them up in every way.

Appendix H: Code of Conduct (Continued)

V

When questioned, should I become a prisoner of war, I am required to give name, rank, service number, and date of birth.

I will evade answering further questions to the utmost of my ability.

I will make no oral or written statements disloyal to my country and its allies or harmful to their cause.

VI

I will never forget that I am an American, fighting for freedom, responsible for my actions, and dedicated to the principles which made my country free.

I will trust in my God and in the United States of America.

Appendix I: Benefits

Health Benefits

TRICARE (Medical Coverage) TRICARE is the Department of Defense's health care program – or the military's equivalent of a medical insurance provider. Active Duty Service Member's are automatically enrolled in the program and receive full medical benefits through a primary care provider at their local military facility. Active duty family members and retirees under the age of 65 are also eligible for medical coverage (your family members are eligible from the first day you enter the Army). Sponsors must enroll their family members in the program through the local Health Benefits Advisor. (This is an important step – you need to ensure that you have enrolled your family in order for them to receive medical care.)

There are three TRICARE programs to choose from. The most common option is TRICARE Prime. Active duty soldiers are automatically enrolled in TRICARE Prime (they have no choice), and most sponsors choose this program for their families also. TRICARE Prime is similar to an HMO (Health Maintenance Organization). You and your family members are assigned to a Primary Care Manager (usually in the closest military facility) who will take care of most of your medical needs. He or she will refer you to a specialist if necessary. The great advantage of TRICARE Prime is that almost all of your medical expenses are paid for. However, you must see your Primary Care Manager first for all health care problems.

Appendix I: Benefits (Continued)

The second option is TRICARE Standard. With TRICARE standard you can choose your own civilian doctor. However, you must pay a yearly deductible (approximately \$100 per person) as well as 20% of all medical bills.

The final option is TRICARE Extra. Under this plan, you may select from a list of TRICARE-participating civilian doctors. You are responsible for 15% of all medical expenses.

Below are a few commonly asked questions about TRICARE.

Q: I am a basic training soldier. My family members are not here with me. How will they get medical care in my hometown?

A: They may enroll in TRICARE Prime if it is available in that area, or they may seek care under TRICARE Extra or TRICARE Standard. The most important step is to talk to the local Health Benefits Advisor to get your family enrolled in your program of choice.

Q: What are the costs to enroll my family in TRICARE Prime?

A: There is no cost for active duty family member enrollment in TRICARE Prime. There may be modest payments for in-patient stays at civilian hospitals (around \$10 per day) or a cost-share when they are referred to civilian doctors (\$6 per visit).

Appendix I: Benefits (Continued)

Q: If my family and I are away from our local military facility, how do we receive medical care?

A: In an emergency (threat to life, limb, eyesight, or broken bones), simply go to the nearest medical facility (civilian or military). If there is no emergency, contact your primary care manager for approval to see a civilian doctor. This makes it important to keep your Primary Care Manager's phone number with you when you are on leave or away from your normal military post.

Dental Coverage

Active duty soldiers receive full dental and orthodontic care through military providers. However, these services are not available to family members, and dental care is not included as a part of TRICARE's coverage. You may enroll your family members in a separate dental insurance program through your local Personnel Action Center (PAC). The insurance costs from about \$8 to \$20 per month depending on the number of dependents you have. It covers the costs of regular cleanings as well as providing partial payment for other procedures and surgery.

Legal Benefits

Judge Advocate Services

The Staff Judge Advocate at each Army post is available to assist soldiers with legal matters such as drafting a will or power of attorney, filing claims against the government for damaged property, and general legal questions.

Appendix I: Benefits (Continued)

Trial Defense Services

In the event that you encounter legal problems during your military career, the Army provides, at no cost to you, defense attorneys who will help you understand your rights and ensure that you are afforded due process. The Trial Defense Service at your local post assists soldiers with issues concerning chapters (removal from the Army), non-judicial punishment under Article 15 of the UCMJ, and other more serious UCMJ offenses (courts martial). While they may give you limited advice, the Trial Defense Service does not provide legal help for matters supervised by a civilian court.

Personal and Family Benefits

Life Insurance (SGLI)

The Servicemen's Group Life Insurance (SGLI) program provides a term life insurance policy. All soldiers on active duty are automatically insured for \$250,000 unless they decline or reduce the coverage. A charge of about \$20 is deducted from your paycheck each month unless you state in writing that you don't want the insurance. Coverage in smaller quantities is available at lower monthly rates. Cancellation of SGLI or changes to a current policy can be done at the unit PAC.

SGLI is an excellent program for military personnel because of its low cost, because it pays in addition to any other survivor benefits, and because it ensures that your survivors will receive compensation even if your event is the result of combat or other high-risk military duties.

Appendix I: Benefits (Continued)

Housing

The Army provides government quarters or a housing allowance for all soldiers. Single soldiers normally live on post in the unit's housing area or the BEQ (Bachelor's Enlisted Quarters). Those in the rank of Sergeant First Class and above may choose to live off post with permission from their commander.

Soldiers in pay grade E4, with two or more years of service, and in pay grades E5 and above, with dependents, are eligible for government-owned or controlled family housing. Installations with adequate quarters assign housing as soon as possible. If no housing is available, your name is placed on a waiting list and you must find off-post accommodations.

If you live off post, you will receive a basic allowance for quarters based on your rank. The money is intended to pay for 80% of the cost of rent and utilities. In most areas, you will also receive a variable housing allowance (VHA). This amount depends on the cost of housing in the area. For example, a soldier stationed in Washington, D.C. receives a greater VHA than one stationed at Fort Benning, Georgia, because living in the D.C. area costs more than living near Columbus, Georgia. The combination of your allowance for quarters and VHA is called BAH – Basic Allowance for Housing. A key benefit of BAH is that it is not taxed when you report your federal income taxes.

Appendix I: Benefits (Continued)

Post Exchange and Commissary

Another important benefit of military service is the opportunity to shop in the post exchange (PX) and commissary.

The post exchange is similar to a department store. There is no state sales tax on exchange items, and prices are often very reasonable. You may purchase items for your own personal use or for gifts, but you may not buy items for resale. You may use any military exchange facility in the United States and some overseas, as long as you are on active duty, retired, on special reserve duty, or are a dependent.

The commissary is a supermarket which can be used by all military personnel and their dependents. Commissaries usually sell food at a lower price than civilian stores, particularly overseas. The government appropriates money to keep commissaries operating, and typically you will save from 20% to 30% by shopping at the commissary.

Leave

As a soldier in the United States Army, you accrue 2 ½ days of leave each month for a total of 30 days per year. Subject to the approval of your chain of command and the requirements of your unit's mission, you can use this leave at your own convenience for any purpose you choose (if you do not use all 30 days, the excess carries over to the following year). A row on your LES is reserved specifically for leave and you can reference this section each month to

Appendix I: Benefits (Continued)

see how much leave you have available. As a new soldier, you will have very few days of leave accrued. In the case of emergencies or special circumstances, your commander is authorized to advance you a certain number of days.

Army Family Team Building (AFTB)

The purpose of the Army Family Team Building program is to increase family readiness, which in turn increases mission accomplishment. It trains family members so that they can help themselves and other families in the event their sponsors deploy. Family training is conducted on three levels. First, the AFTB program teaches families how to manage their personal affairs, and where to find assistance if necessary. On the second level, AFTB trains family members to assist community organizations such as the Red Cross, Family Support Groups, church groups, and other community activities. Finally, the third level prepares volunteer family members to assume a leadership role in the aforementioned organizations. Each installation has its own AFTB program.

Appendix J: Promotions

With the exception of your initial promotion from PVT to PV2, advancements in the Army are not automatic. Your chain of command will promote you or recommend you for promotion on the basis of your performance and increasing competency in your MOS.

Promotion to PV2: A private will be advanced to PV2 after completing six months of service (barring any adverse legal actions). Local commanders may recognize outstanding performance by promoting privates to PV2 after only four months. This is done by employing a promotion waiver. These waivers are limited in number and only available to the very best soldiers.

Promotion to PFC: Commanders may promote PV2s with 12 months of time in service and four months time in grade to Private First Class (E3). Waivers are also available for PFC with as few as six months time in service and two months time in grade.

Promotion to Specialist: A PFC is eligible for promotion to specialist with 26 months time in service and 6 months time in grade. Commanders may promote outstanding performers to SPC with a waiver at as few as 18 months time in service and 6 months time in grade.

Once you reach the rank of SPC, you must go before a local promotion board to gain eligibility for advancement to the rank of Sergeant. The promotion board tests you on

Appendix J: Promotions (Continued)

a number of items including leadership competency, basic soldier knowledge and skills, oral communication skills, and personal appearance, bearing, and self confidence.

If you succeed at the promotion board, your NCO Support Channel will recommend you for promotion and, based on an Army-wide point system, you will advance to Sergeant when you have met the “Promotion Point Cutoff” for your MOS.

Appendix K: Managing Personal Finances

It is your duty as a soldier to fulfill all of your financial obligations and provide for your family. There are several components that are key to achieving this task. The first is to ensure that you are properly receiving your paycheck.

Sure-Pay and Banking Accounts:

The Army requires all soldiers to enroll in the Sure-Pay program. This means that you must have your paycheck deposited directly to a checking or savings account. If you close or change this account, you must ensure that you go to your local PAC and fill out the proper forms to update your Sure-Pay data. The Army will pay you once per month on the 1st of each month, or twice per month on the 1st and the 15th. You are free to choose your preferred option based on your budgeting necessities.

Regardless of which option you choose, you must carefully review your monthly Leave and Earnings Statement (LES) to ensure that your pay is being deposited properly and you are receiving all of the benefits (Base Pay, BAH, etc.) that you are entitled to.

Some key items to consider when choosing the financial institution at which you will keep your direct deposit account are:

- Is there a monthly service charge for maintaining a checking account? If so, look for a

Appendix K: Managing Personal Finances (Continued)

different bank. Numerous institutions offer free checking as long as you have set up Sure-Pay.

- Is there a charge for using ATMs? Cash withdrawal charges can be expensive. You should be able to find a bank that does not charge ATM fees at its branches.

- Does the bank have branches available throughout the country? Since the Army requires you to move frequently, it is important to consider a bank that provides service at the numerous military installations where you may be stationed. While a local bank may still be your best option, understand that you may endure some difficulty when you PCS and have to switch your account to a new bank.

Check Writing

Managing your checkbook will be a critical factor in properly administering your personal finances. You must pay close attention to each transaction to ensure that you always know your checking account balance. This will ensure that you do not write a bad check (a check that you do not have sufficient funds to cover).

There are several consequences for writing a bad check.

Your bank and the institution to which the check was written may each assess a service charge often as much as

Appendix K: Managing Personal Finances (Continued)

\$15 – and sometimes even higher if they use a percentage system based on the amount of your check.

Your reputation and credit rating may be damaged, making it difficult to purchase a car, home, or other items that require a loan.

You could lose check-writing privileges on post.

If you bounce a check on post, your commander or 1SG will receive notification and you may be reprimanded or punished.

Appendix L: Explanation of the Leave and Leave and Earnings Statement (LES)

The LES is your detailed pay statement issued at the end of each month. The chart below helps explain some of the key information on your LES. If you have further questions, or notice an error on your statement, ensure that you report it to your chain of command, or go to your Personnel Action Center (PAC) for assistance.

Entitlements	Deductions	Allotments	Summary
<p>This section shows all of the money that you have earned: Base Pay, Basic Allowance for Subsistence (BAS), Basic Allowance for Housing (BAH), and possibly clothing allowance, Family Separation Pay, or any other special pay. At the bottom, you will see TOTAL, indicating the sum of all of your entitlements for the month.</p>	<p>These are the deductions taken from your entitlements and include federal taxes, FICA or social security taxes, Medicare taxes, SGLI, Dental premiums (if you have requested coverage), and various other items. Mid-month pay will also be listed here, as it is a “deduction” from your end of month entitlements.</p>	<p>If you have signed up for any allotments, they will be listed here.</p>	<p>The bottom line in this section is your End of Month Pay (EOM). The amount listed in the EOM PAY block is the amount that will be deposited in your bank on payday. It equals your entitlements minus your deductions and allotments.</p>

Appendix L: Explanation of the Leave and Leave and Earnings Statement (LES) (Continued)

LEAVE	The most important item in this row is the CR FWD block. It indicates the amount of leave you currently have available.
--------------	--

FICA TAXES	The rows labeled FICA TAXES, FED TAXES, and STATE TAXES simply let you know how much of your pay has been taken out for taxes during the year.
-------------------	--

PAY DATA	In this section, pay attention to BAH Type (it should be with dependent, without dependent(s), or BAH differential depending on your situation). Also, ensure that the BAH Zip Code correctly identifies the area where you (or your dependents) are living. If it is incorrect, and you are receiving too much money, you will eventually have to pay it back.
-----------------	--

Remarks:

Various items will be listed in the remarks section each month. Some examples include: voting information, pay increase announcements, and other announcements from the Defense Finance and Accounting Service. On the right side, you will see leave dates (if you have taken any during the pay period), allotment information, your bank account information, advance pay debt balances, and other information specific to your individual pay situation.

Appendix M: Common Military Acronyms and Abbreviations

AA	Assembly Area
AAFES	Army and Air Force Exchange Service
ACS	Army Community Service
ADAPCP	Alcohol and Drug Abuse Prevention and Control Program
AER	Army Emergency Relief
AIT	Advanced Individual Training
APFT	Army Physical Fitness Test
AR	Army Regulation
ARNG	Army National Guard
ASAP	As soon as possible
AT	Anti-tank
AWOL	Absent Without Leave
BAH	Basic Allowance for Housing
BCT	Basic Combat Training
BDU	Battle Dress Uniform
BEQ	Bachelor Enlisted Quarters
BRM	Basic Rifle Marksmanship
BSA	Brigade Support Area
CO	Commanding Officer
COA	Course of Action
CONUS	Continental United States
CPR	Cardiopulmonary Resuscitation
CQ	Charge of Quarters
DA	Department of the Army

Appendix M: Common Military Acronyms and Abbreviations (Continued)

DEERS	Defense Enrollment Eligibility Reporting System
DENTAC	Dental Activity
DFAC	Dining Facility
DOD	Department of Defense
EPW	Enemy Prisoner of War
FM	Field Manual or Foot March
FRAGO	Fragmentary Order
FRG	Family Readiness Group
FTX	Field Training Exercise
HMMWV	High Mobility Multi-purpose Wheeled Vehicle
IAW	In accordance with
IET	Initial Entry Training
IG	Inspector General
JAG	Judge Advocate General
JRTC	Joint Readiness Training Center
KP	Kitchen Patrol
LBE/LCE	Load Bearing (or Carrying) Equipment
LD	Line of Departure
LES	Leave and Earnings Statement
LRP	Logistics Release Point

Appendix M: Common Military Acronyms and Abbreviations (Continued)

MOPP	Mission Oriented Protective Posture
MOS	Military Occupational Specialty
MP	Military Police
MRE	Meal, Ready to Eat
MTOE	Modified Table of Organization and Equipment
MWR	Morale, Welfare, and Recreation
NBC	Nuclear, Biological, Chemical
NCO	Noncommissioned Officer
NLT	Not later than
NTC	National Training Center
OCONUS	Outside the Continental United States
OPORD	Operations Order
OSUT	One Station Unit Training
PAC	Personnel Action Center
PCS	Permanent Change of Station
PCI	Pre-Combat Inspection
PMCS	Preventive Maintenance Checks and Services
POW	Prisoner of War
PT	Physical Training
PX	Post Exchange
RTO	Radio and Telephone Operator
ROE	Rules of Engagement

Appendix M: Common Military Acronyms and Abbreviations (Continued)

SAW	Squad Automatic Weapon
SALUTE	Size, Activity, Location, Unit, Time, Equipment
SDNCO	Staff Duty Noncommissioned Officer
SGLI	Servicemen's Group Life Insurance
SOP	Standard Operating Procedure
SPORTS	Slap, Pull, Observe, Release, Tap, Squeeze
TDY	Temporary Duty
TOC	Tactical Operations Center
TRADOC	Training and Doctrine Command
UCMJ	Uniform Code of Military Justice
USAR	United States Army Reserve
VIP	Very Important Person

OATH OF ENLISTMENT

I, (State your name), Do solemnly swear “or affirm” that I will support and defend, the Constitution of the United States against all enemies, foreign and domestic; that I will bear true faith and allegiance to the same; and that I will obey the orders of the President of the United States and the orders of the Officers appointed over me, according to regulations and the Uniform Code of Military Justice. So help me God!

